



## Level Control Valve

with Altitude Pilot

### WW-750-80-X

- High level reservoirs & water towers
- Energy cost critical systems
- Systems with poor water quality
- Inherent refreshing
- Level sustaining at reservoir outlet

The Model 750-80-X Level Control Valve is a hydraulically controlled, diaphragm actuated control valve that shuts off at pre-set reservoir high level and fully opens in response to an approximately one meter (three foot) level drop, as sensed by the 3-Way altitude pilot mounted on the main valve.



### Features and Benefits

- **Line pressure driven** – Independent operation
- **Bi-level altitude pilot**
  - No float, simple installation
  - On/Off service
  - No cavitation damage
  - Suitable for low quality water
  - Reservoir inherent refreshing
- **Double chamber design**
  - Moderated valve reaction
  - Protected diaphragm
- **External installation**
  - Easy access to valve
  - Easy level setting
  - Less wear and tear
- **Balanced seal disk** – High flow capacity
- **In-line serviceable** – Easy maintenance
- **Flexible design** – Easy addition of features

### Major Additional Features

- Modulating altitude control – **750-82**
- Pressure sustaining (for 750-80-X) – **753-80-X**
- Pressure sustaining (for 750-82) – **753-82**
- Bi-directional flow – **750-87-X (780-70-X)**
- Full powered opening & closing – **750-80-B**
- Closing surge prevention – **750-80-49**
- Bi-level altitude control – **750-86**
- Level sustaining with high sensitivity pilot – **75A-83**

See relevant BERMAD publications.



## Operation

The Model 750-80-X is a pilot controlled valve equipped with an adjustable, 3-Way altitude pilot. The pilot senses the static head of the reservoir level via a tube [1] connected to a “still point” at the bottom of the reservoir.

Should static head rise to pilot setting, the pilot [2] applies pressure to the upper control chamber [3] via cock valve [4], powering the main valve to shut off.

Should static head fall below pilot setting approximately 1m (3 ft), the pilot vents the upper control chamber, causing the main valve to fully open.

The 3-Way cock valve [4] enables manual closing of the main valve.

For 10” valves and larger, an accelerator [5] quickens valve response.

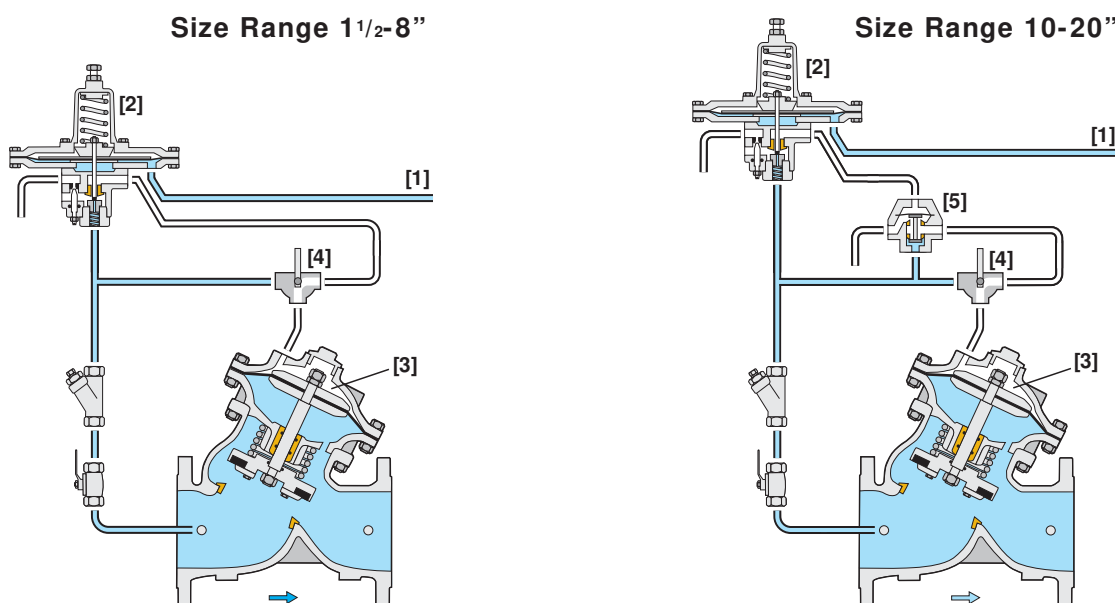

## Engineer Specifications

The Level Control Valve shall shut off at pre-set reservoir high level and fully open in response to an approximately one meter (three foot) level drop, as sensed by the 3-Way altitude pilot mounted on the main valve.

**Main Valve:** The main valve shall be a center guided, diaphragm actuated globe valve of either oblique (Y) or angle pattern design. The body shall have a replaceable, raised, stainless steel seat ring. The valve shall have an unobstructed flow path, with no stem guides, bearings, or supporting ribs. The body and cover shall be ductile iron. All external bolts, nuts, and studs shall be Duplex® coated. All valve components shall be accessible and serviceable without removing the valve from the pipeline.

**Actuator:** The actuator assembly shall be double chambered with an inherent separating partition between the lower surface of the diaphragm and the main valve. The entire actuator assembly (seal disk to top cover) shall be removable from the valve as an integral unit. The stainless steel valve shaft shall be center guided by a bearing in the separating partition. The replaceable radial seal disk shall include a resilient seal and shall be capable of accepting a V-Port Throttling Plug by bolting.

**Control System:** The control system shall consist of a 3-Way, altitude pilot valve with a covered, centered spring and 8” (200 mm) sensing diaphragm, (for 10” and larger valves, an accelerator shall be added to the solenoid), an isolating cock valve, a 3-way cock valve, and a filter. All fittings shall be forged brass or stainless steel. The assembled valve shall be hydraulically tested.

**Quality Assurance:** The valve manufacturer shall be certified according to the ISO 9001 Quality Assurance Standard. The main valve shall be certified as a complete drinking water valve according to NSF, WRAS, and other recognized standards.



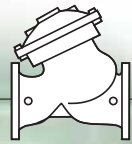

## Typical Applications

### Bi-Level Water Towers

The Model 750-80-X senses the static head of the water level in the tank by means of a high sensitivity pilot. To do so accurately, the sensing tube end must be connected to a “still point” at the bottom of the tank. The drainage pipe provides this “still point”, a location not influenced by flow velocity as in filling and outflow pipes.

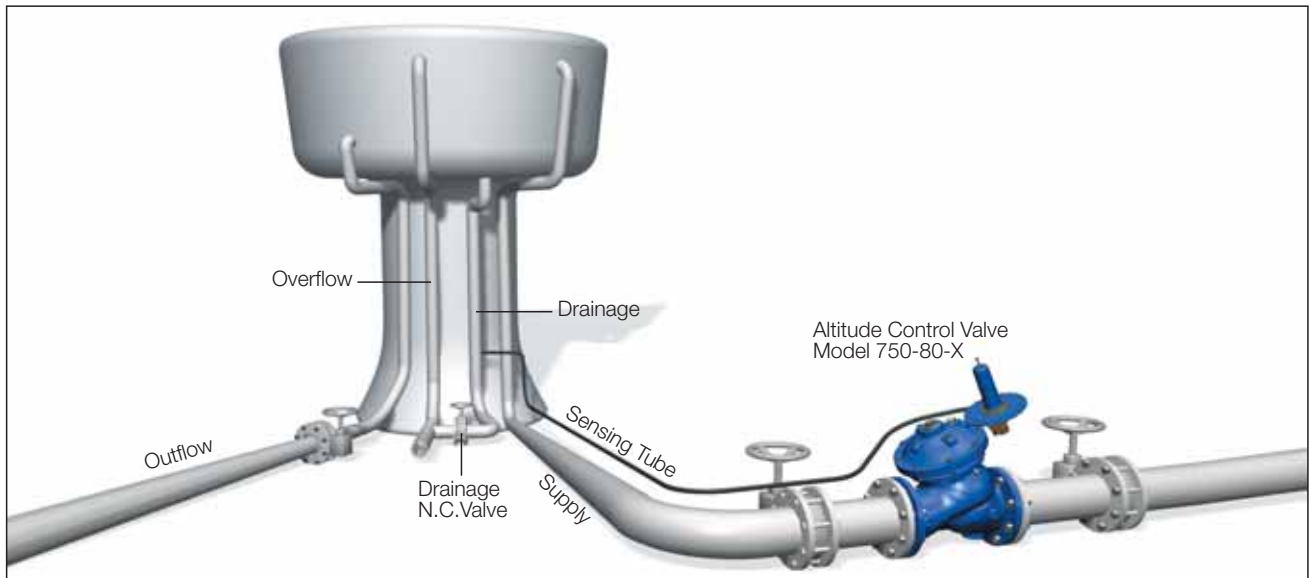

### Level Control and Pressure Sustaining Valve with Altitude Pilot Model 753-80-X

The Model 753-80-X adds the altitude control feature to the Model 730 Pressure Sustaining Valve for applications where prioritizing consumers over reservoir filling is needed. The altitude pilot [1] controls the Pressure Sustaining Control Valve by applying pressure to & venting from the pressure sustaining pilot [2] sealed spring cell. Should the altitude pilot sense static head at the setting, it applies pressure to the pressure sustaining pilot spring cell, and the main valve closes. The downstream cock valve [3] enables manual closing.

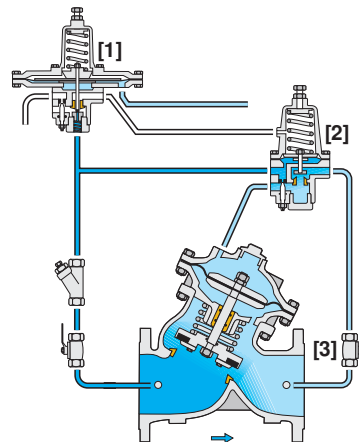

### Level Control Valve with Bi-Level Altitude Control Model 750-86

The Model 750-86 adds a low level setting feature to the standard Altitude Control Valve.

A high level pilot [1] and a low level pilot [2] are adjusted to open at different settings. Should the static head rise to the closing set point, the high level pilot opens causing the main valve to close. Should the static head drop to the opening set point, the low level pilot opens causing the main valve to open. When the level is between pilot settings, both pilots are closed and the main valve remains in its last position.

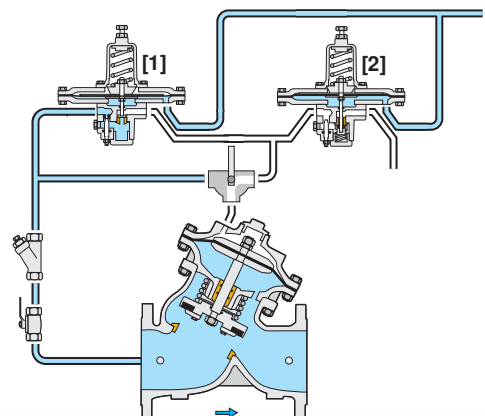

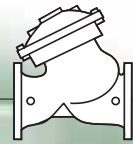

### “Always Full” - Shallow Reservoirs

In these reservoirs, the water level should be kept as constant as possible.

The Level Control Valve with modulating altitude pilot Model 750-82 is well suited to fulfill this condition.

The altitude pilot is highly sensitive to changes and accurately maintains level within a few centimeters.

To do so, the sensing tube end must be connected to a “still point” at the bottom of the reservoir.

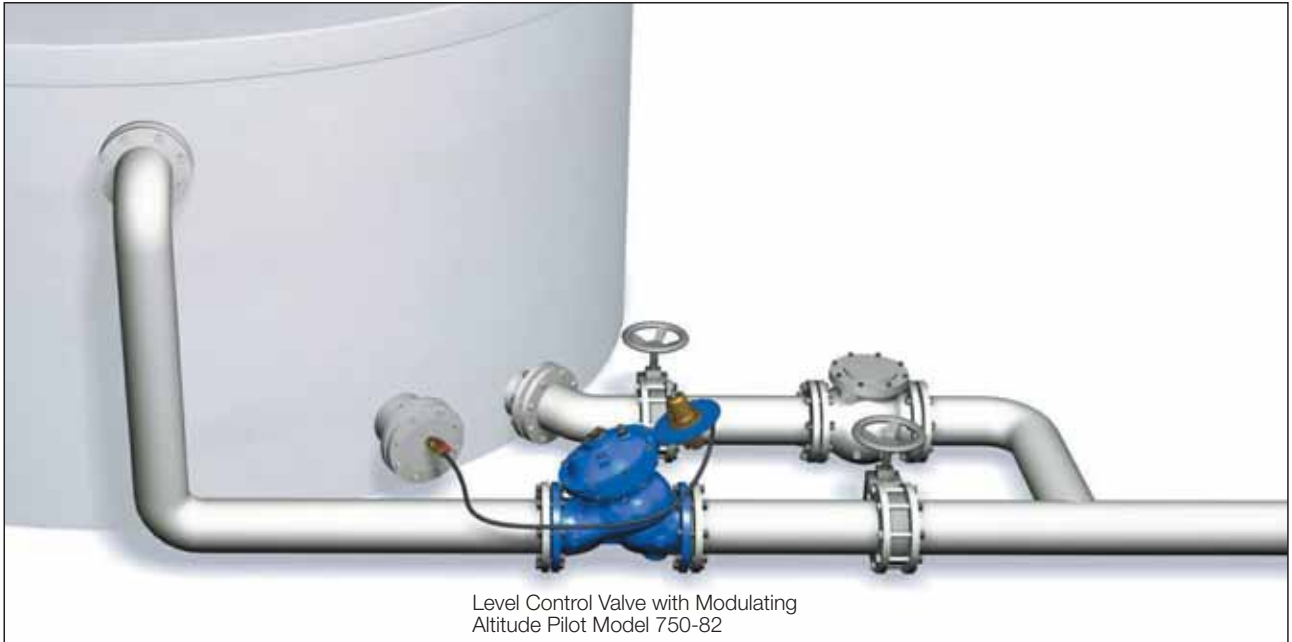

Level Control Valve with Modulating Altitude Pilot Model 750-82

### Level Control Valve with Modulating Altitude Pilot Model 750-82

The Model 750-82 modifies the Model 750-80-X “on-off” feature into a modulating feature to maintain an “always full” reservoir.

The needle valve [1] continuously allows flow from valve inlet into the upper control chamber [2]. The pilot [3] senses static head via a sensing tube [4].

Should the static head rise towards pilot setting, the pilot throttles, causing the main valve to throttle closed, reducing filling rate, and eventually closing drip tight. The downstream cock valve [5] enables manual control closing.

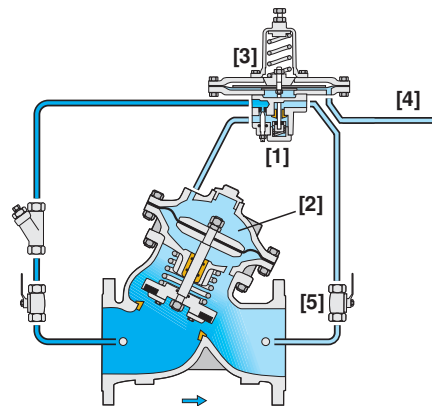

### Adding the Pressure Sustaining Feature Model 753-82

The Model 753-82 combines the modulating altitude control feature with the Model 730 Pressure Sustaining Valve for applications where prioritizing consumers over reservoir filling is needed.

The needle valve [1] continuously allows flow from valve inlet into the upper control chamber [2]. The pressure sustaining pilot [3] and the 2-Way altitude pilot [4] control outflow from the upper control chamber.

When reservoir static head decreases below altitude pilot setting, the main valve modulates open while sustaining pre-set minimum upstream pressure. The downstream cock valve [5] enables manual closing.

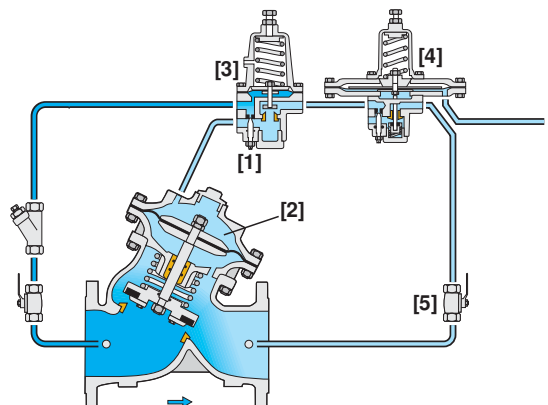

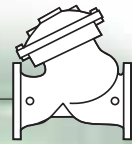

### Bi-Directional Flow Level Control Model 750-87-X

The Model 750-87-X modifies the Model 750-80-X to allow bi-directional flow. It saves the need for a line sized, by-pass check valve for reservoirs where the supply line also serves as the outflow line.

During filling, this valve functions as a standard Model 750-80-X, while the control check valve [1] prevents upstream pressure from entering the pilot [2] sensing chamber.

Should upstream pressure fall below reservoir static head, the pilot senses “false” low static head, due to the restricted flow released to valve inlet, through the needle valve [3], and the check valve [1]. The pilot then opens the main valve allowing reverse flow from the reservoir.

The 3-Way cock valve [4] enables manual closing of the main valve.

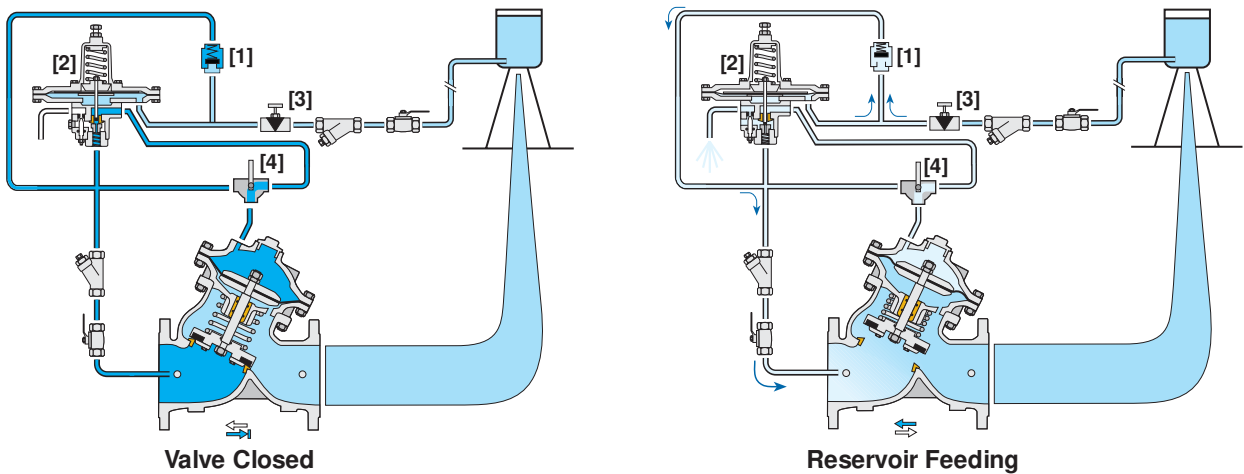

### Level Sustaining Valve at Reservoir Outlet Model 75A-83

The Model 75A-83 is an altitude pilot controlled valve designed to maintain minimum reservoir volume.

The needle valve [1] continuously allows flow from valve inlet into the upper control chamber [2]. The pilot [3] senses static head from a “still-point” at the bottom of the reservoir.

Should this head decrease towards pilot setting, the pilot throttles, enabling pressure to accumulate in the upper control chamber causing the main valve to throttle closed and restrict outflow, and eventually close to maintain minimum level.

When reservoir level rises above pilot setting, the pilot releases accumulated pressure from the upper control chamber causing the main valve to modulate open.

To ensure adequate operating pressure, the valve must be positioned sufficiently below the reservoir bottom.

The downstream cock valve [4] enables manual closing.

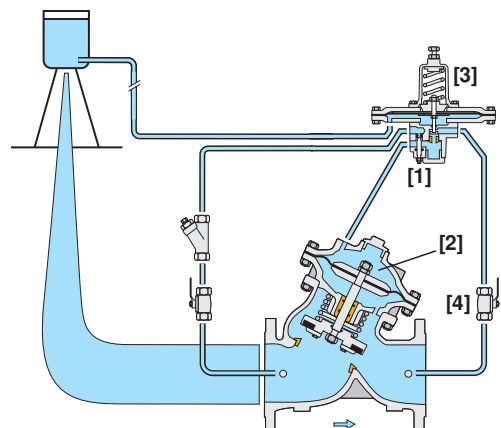



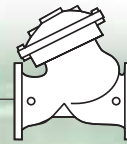

### WW-750-80-X

For full technical details, refer to Engineering Section.

## Technical Data

### Dimensions and Weights

Size	A, B	C	L	H	Weight	
mm inch	mm inch	mm inch	mm inch	mm inch	kg lbs	
40	1 1/2"	350 14	180 7	205 8.1	239 9.4	9.1 20
50	2"	350 14	180 7	210 8.3	244 9.6	10.6 23
65	2 1/2"	350 14	180 7	222 8.7	257 10.1	13 29
80	3"	370 15	230 9	250 9.8	305 12.0	22 49
100	4"	395 16	275 11	320 12.6	366 14.4	37 82
150	6"	430 17	385 15	415 16.3	492 19.4	75 165
200	8"	475 19	460 18	500 19.7	584 23.0	125 276
250	10"	520 21	580 23	605 23.8	724 28.5	217 478
300	12"	545 22	685 27	725 28.5	840 33.1	370 816
350	14"	545 22	685 27	733 28.9	866 34.1	381 840
400	16"	645 26	965 38	990 39.0	1108 43.6	846 1865
450	18"	645 26	965 38	1000 39.4	1127 44.4	945 2083
500	20"	645 26	965 38	1100 43.3	1167 45.9	962 2121

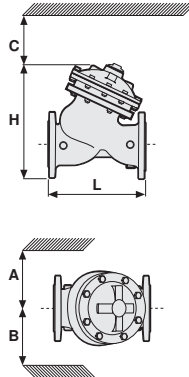

Data is for Y-pattern, flanged, PN16 valves  
 Weight is for PN16 basic valves  
 "C" enables removing the actuator in one unit  
 "L", ISO standard lengths available  
 For more dimensions and weights tables, refer to Engineering Section

### Flow Chart

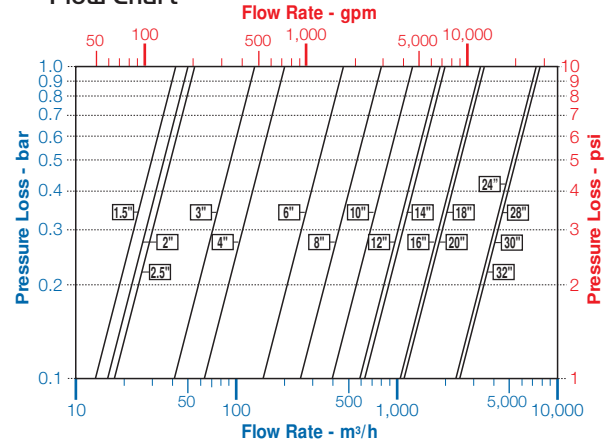

Data is for Y-pattern, flat disk valves  
 For more flow charts, refer to Engineering Section

### Main Valve

- Valve Patterns:** "Y" (globe) & angle
- Size Range:** 1 1/2-32" (40-800 mm)
- End Connections (Pressure Ratings):**
- Flanged:** ISO PN16, PN25 (ANSI Class 15 0, 300)
- Threaded:** BSP or NPT
- Others:** Available on request
- Working Temperature:** Water up to 80°C (180°F)
- Standard Materials:**
- Body & Actuator:** Ductile Iron
- Internals:** Stainless Steel, Bronze & coated Steel
- Diaphragm:** NBR Nylon fabric-reinforced
- Seals:** NBR
- Coating:** Fusion Bonded Epoxy, RAL 5005 (Blue) NSF & WRAS approved or Electrostatic Polyester Powder, RAL 6017 (Green)

### Control System

- Standard Materials:**
- Accessories:** Bronze, Brass, Stainless Steel & NBR
- Tubing:** Copper or Stainless Steel
- Fittings:** Forged Brass or Stainless Steel
- Pilot Standard Materials:**
- Body & cover:** Brass, Bronze or Stainless Steel
- Elastomers:** NBR
- Springs:** Galvanized Steel or Stainless Steel
- Internals:** Stainless Steel
- Diaphragm covers:** Fusion bonded epoxy coated Steel or Stainless Steel

### Altitude Adjustment Range

Code	meter	feet
M6	2-14	7-46
M5	5-22	17-72
M4	15-35	49-115
M8	25-70	82-230

- Shut-off level repeatability: 10 cm (4")
- Re-opening level: approx. 1m (3 ft) below shut-off level

## How to Order

Please specify the requested valve in the following sequence: (for more options, refer to Ordering Guide)

Sector	Size	Primary Feature	Additional Feature	Pattern	Body Material	End Connections	Coating	Voltage & Position	Tubing & Fittings	Additional Attributes
WW	6"	750	80 M6	Y	C	16	EB	-	CB	XI
Waterworks	1 1/2 - 32"	Level Control	Oblique (up to 20") Angle (up to 18") Globe (24-32" only)	Y A G	Epoxy FB Blue Polyester Green Polyester Blue Uncoated	24VAC/50Hz - N.C. 24VAC/50Hz - N.O. 24VDC - N.C. 24VDC - N.O. 24VDC - L.P. 220VAC/50-60Hz N.C. 220VAC/50-60Hz N.O.	EB PG PB UC	Copper Tubing & Brass Fittings Plastic Tubing & Brass Fittings St. St. 316 Tubing & Fittings	CB PB NN	3-Way Control Loop Double Chambered Valve Position Indicator Large Control Filter V-Port Throttling Plug Orifice Assembly Electric Limit Switch St. St. 316 Control Accessories St. St. 316 Internal Trim (Closure & Seat) St. St. 316 Actuator Internal Assembly Delrin Bearing Viton Elastomers for Seals & Diaphragm
Closing Surge Prevention		49	Ductile Iron Standard	C						X
Modulating Horizontal Float		60	Cast Steel	S						B
Bi-Level Electric Float		65	St. Steel 316	N						I
Bi-Level Vertical Float		66	Nickel Alumin. Bronze	U						F
Modulating Vertical Float		67	ISO-16	16						V
Altitude Pilot		80	ISO-25	25						U
Modulating Altitude Pilot		82	ANSI-150	A5						S
Sustaining Altitude Pilot		83	ANSI-300	A3						N
Bi-Level Altitude Control		86	ANSI-16	J6						T
2-14 Meter Setting Altitude Pilot	M6		JIS-16	J6						D
5-22 Meter Setting Altitude Pilot	M5		JIS-20	J2						R
15-35 Meter Setting Altitude Pilot	M4									E
25-70 Meter Setting Altitude Pilot	M8									
Multiple choices permitted										

