

## Electrically Controlled On-Off Deluge Valve

Model: FP 400E-3D



UL LISTED

### Typical Applications

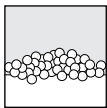

Water/foam fire systems

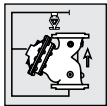

Deluge & spray systems

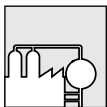

Petrochemical facilities



Flammable materials storage

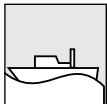

Marine environments

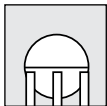

Gas storage tanks

### Features and Benefits

- **3-way solenoid valve** – Flexible configuration
- **Remote reset** – Shut-off on remote command
- **One-piece molded elastomeric moving part** – No maintenance required
- **Simple design** – Cost effective
- **Obstacle-free Full bore** – Uncompromising reliability
- **Factory pre-assembled trim** – Out-of-box quality
- **In-line serviceable** – Minimal down time

### Optional Features

- **Alarm pressure-switch** (code: P or P7)
- **Explosion-proof** for hazardous locations (code: 7/8/9)
- **Fail-safe open** (energized to close main valve)
- **Seawater service** (add FS as prefix to model)
- **Valve Position Single/Double Limit Switches**

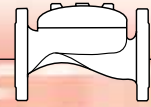

## Operation

The BERMAD Model FP 400E-3D is suitable for systems that include electric fire detection and a piping system with a wide variety of open nozzles.

In the SET position, the line-pressure, which is supplied to both the main valve's control chamber [1] and a Hydraulic Relay Valve (HRV-2) [2], through the priming line [3], a Check Valve [4], an Accelerator [5] with priming restriction and a 3-Way Solenoid [6], is trapped by the Check Valve, by the closed HRV-2, and by a closed Manual Emergency Release [7]. The trapped pressure holds the main valve's diaphragm and plug against the valve seat [8], sealing it drip-tight and keeping the system piping dry. The HRV-2 is held closed by the line-pressure through the solenoid.

Under FIRE or TEST conditions, an electric detection system working through a control panel, triggers the solenoid to open the HRV-2, causing water to exit through the Accelerator faster than it can be supplied. Pressure is then released from the main valve control chamber by the opened HRV-2 or the Manual Emergency Release, allowing the main valve to open and water to flow into the system piping and to the alarm device (if mounted).

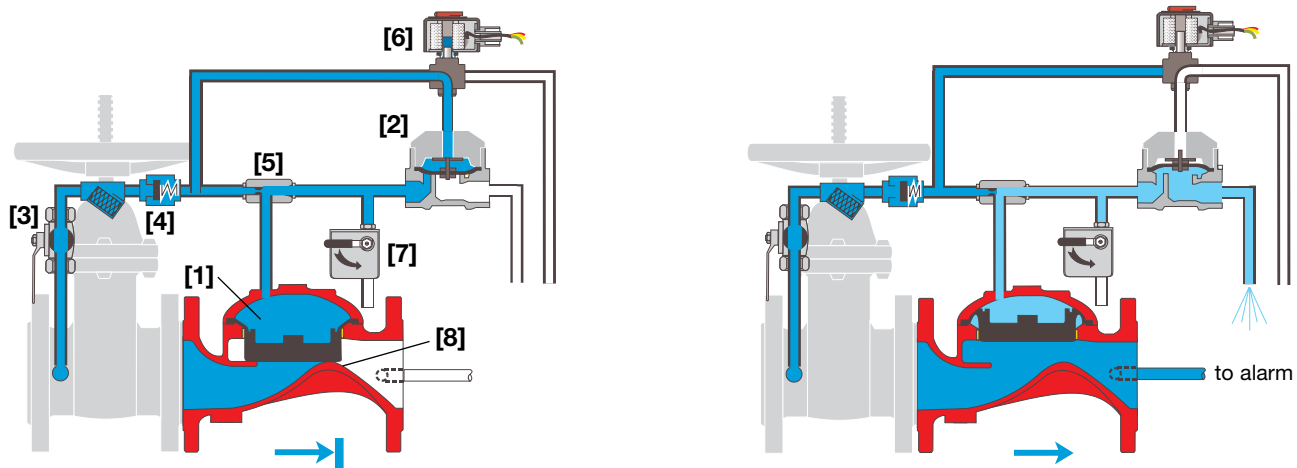

Valve Closed (set position)

Valve Open (operating condition)

## Engineer Specifications

- The On-Off deluge valve shall be a UL-Listed, electrically controlled elastomeric type globe valve with a rolling-diaphragm.
- The valve shall have an unobstructed flow path, with no stem guide or supporting ribs.
- Valve actuation shall be accomplished by a fully peripherally supported, one-piece balanced rolling-diaphragm, vulcanized with a rugged radial seal disk. The diaphragm assembly shall be the only moving part.
- The valve shall have removable cover for quick in-line service enabling all necessary inspection and servicing.
- The control trim materials shall be S.S.316 tubing and fittings and plated brass accessories, including, Y strainer, 3-Way Solenoid, Accelerator, Hydraulic Relay Valve (HRV-2) and Manual Emergency Release.
- The control trim shall be supplied as an assembly, pre-assembled and hydraulically tested at an ISO 9000 and 9001 certified factory.
- The Electrically Controlled, On-Off Deluge Valve shall open in response to an electric signal.

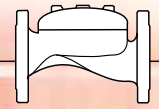

## System Components

- 1 - Main Valve, BERMAD FP 400E Series
- 2B - Accelerator with Priming Restriction
- 4B - Priming Strainer
- 7B - Check Valve
- 15B - Manual Emergency Release
- 24B - 3-Way Solenoid
- 26B - Hydraulic Relay Valve (HRV-2)
- Optional
- P - Pressure Switch
- S - Valve Position Limit Switch / Switches

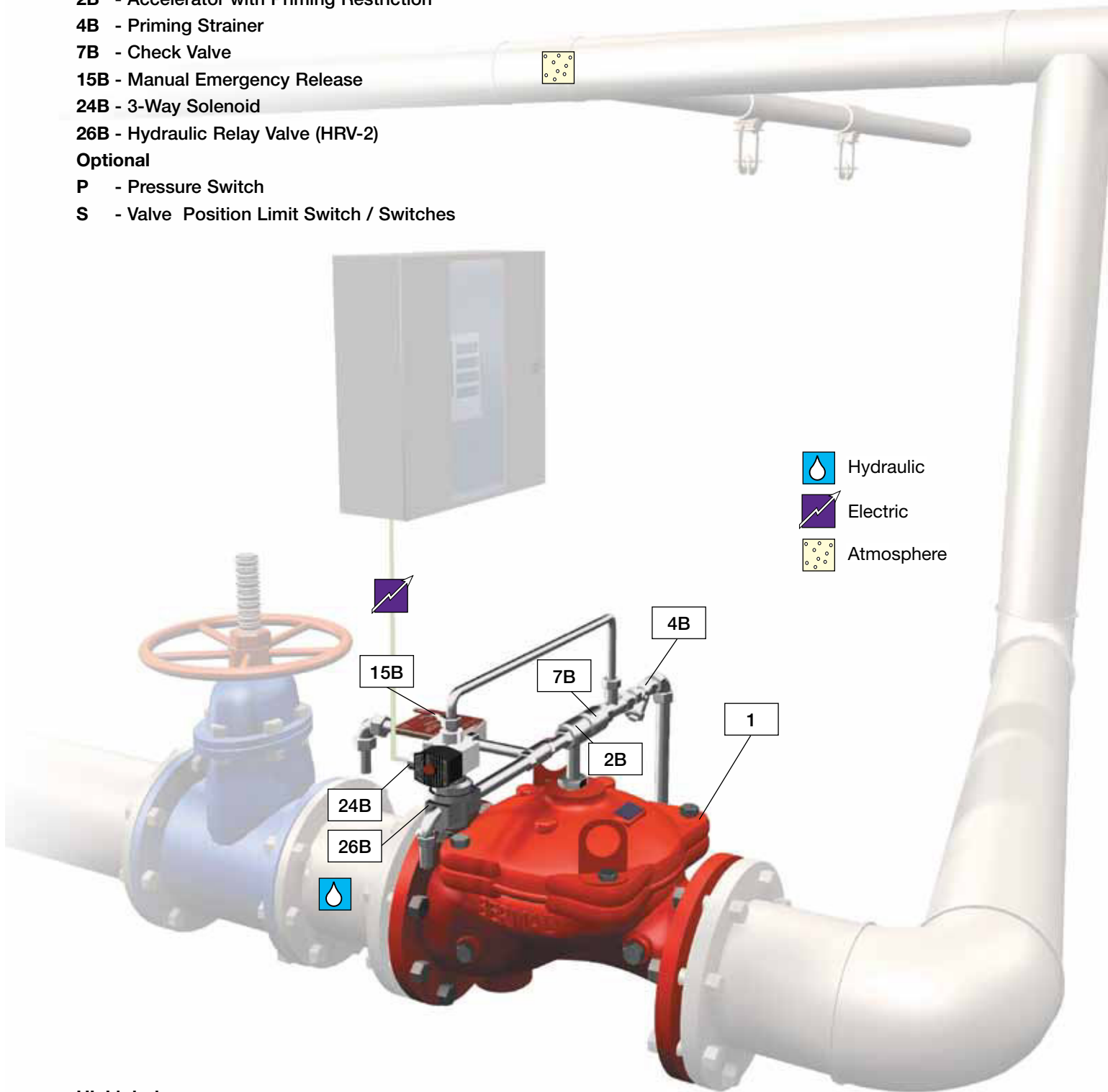

### UL Listed

The BERMAD Model FP 400E-3D is UL-Listed.

The installation shall include Indicating and Drain Components.

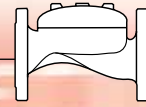

## Technical Data

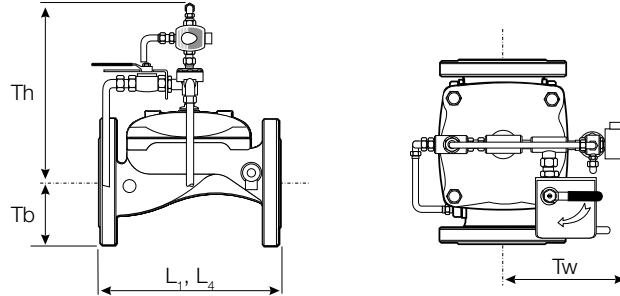

Size	1½"		2"		2½"		3"		4"		6"		8"		10"		12"		
	mm	inch	mm	inch	mm	inch	mm	inch	mm	inch	mm	inch	mm	inch	mm	inch	mm	inch	
Dimensions	L <sub>1</sub> <sup>(1)</sup>	205	8 <sup>1</sup> / <sub>16</sub>	205	8 <sup>1</sup> / <sub>16</sub>	205	8 <sup>1</sup> / <sub>16</sub>	257	10 <sup>2</sup> / <sub>16</sub>	320	12 <sup>10</sup> / <sub>16</sub>	415	16 <sup>5</sup> / <sub>16</sub>	500	19 <sup>11</sup> / <sub>16</sub>	607	23 <sup>14</sup> / <sub>16</sub>	725	28 <sup>9</sup> / <sub>16</sub>
	L <sub>4</sub> <sup>(2)</sup>	205	8 <sup>1</sup> / <sub>16</sub>	205	8 <sup>1</sup> / <sub>16</sub>	N/A	N/A	257	10 <sup>2</sup> / <sub>16</sub>	320	12 <sup>10</sup> / <sub>16</sub>	N/A	N/A	500	19 <sup>11</sup> / <sub>16</sub>	N/A	N/A	N/A	N/A
	Tw	255	10 <sup>1</sup> / <sub>16</sub>	255	10 <sup>1</sup> / <sub>16</sub>	255	10 <sup>1</sup> / <sub>16</sub>	255	10 <sup>1</sup> / <sub>16</sub>	255	10 <sup>1</sup> / <sub>16</sub>	255	10 <sup>1</sup> / <sub>16</sub>	255	10 <sup>1</sup> / <sub>16</sub>	255	10 <sup>1</sup> / <sub>16</sub>	255	10 <sup>1</sup> / <sub>16</sub>
	Tb	64	2 <sup>8</sup> / <sub>16</sub>	78	3 <sup>1</sup> / <sub>16</sub>	89	3 <sup>8</sup> / <sub>16</sub>	100	3 <sup>15</sup> / <sub>16</sub>	115	4 <sup>8</sup> / <sub>16</sub>	140	5 <sup>8</sup> / <sub>16</sub>	172	6 <sup>12</sup> / <sub>16</sub>	204	8 <sup>1</sup> / <sub>16</sub>	242	9 <sup>8</sup> / <sub>16</sub>
	Th	289	11 <sup>6</sup> / <sub>16</sub>	289	11 <sup>6</sup> / <sub>16</sub>	301	11 <sup>14</sup> / <sub>16</sub>	325	12 <sup>13</sup> / <sub>16</sub>	345	13 <sup>9</sup> / <sub>16</sub>	420	16 <sup>9</sup> / <sub>16</sub>	471	18 <sup>9</sup> / <sub>16</sub>	471	18 <sup>9</sup> / <sub>16</sub>	588	23 <sup>2</sup> / <sub>16</sub>

- Notes:**
- L<sub>1</sub> is for flanged ANSI #150 and ISO PN16.
  - L<sub>4</sub> is for grooved end connections (Ductile Iron Only).
  - Provide adequate space around valve for maintenance.
  - Data is for envelope dimensions, specific component positioning may vary.

### Connection Standard

- Flanged: ANSI B16.42 (Ductile Iron), B16.5 (Steel & Stainless Steel), B16.24 (Bronze)
- ISO PN16
- Grooved: ANSI/AWWA C606 for 2, 3, 4, 6 & 8"

### Water Temperature

- 0.5 – 50°C (33 – 122°F)

### Available Sizes

- 1½, 2, 2½, 3, 4, 6, 8, 10 & 12"
- UL-Listed for sizes 1½, 2, 2½, 3, 4, 6, 8 & 10"

### Pressure Rating\*

- Max. working pressure: 250 psi (17 bar)
- \* Pressure rating might be limited due to solenoid valve rating

### Manufacturers Standard Materials

#### Main valve body and cover

- Ductile Iron ASTM A-536

#### Main valve internals

- Stainless Steel 304 & Cast Iron

#### Control Trim System

- Brass control components/accessories
- Stainless Steel 316 tubing & fittings

#### Elastomers

- Nylon fabric reinforced polyisoprene NR

#### Coating

- Electrostatic Powder Coating Poleyester, Red (RAL 3002)

### Optional Materials

#### Main valve body

- Carbon Steel ASTM A-216 WCB
- Stainless Steel 316
- Ni-Al-Bronze ASTM B-148

#### Control Trim

- Stainless Steel 316
- Monel® and Ni-Al-Bronze
- Hastalloy C-276

#### Elastomers

- NBR
- EPDM

#### Coating

- High Build Epoxy Fusion-Bonded with UV Protection, Anti-Corrosion

### Solenoid Pilot Valves

#### Standard

- 3-Way, direct actuated type
- Brass body
- Main valve closed when de-energized
- Enclosure: General purpose watertight, NEMA 4 and 4X / IP65, Class F
- Power: 24VDC, 8 watts
- UL – Listed

#### Options (see also ordering guide)

- Hazardous locations:
  - Class I Division 1, Gr. A, B, C, D, T4 (code 7)
  - Class I Division 2, Gr. A, B, C, D, T4
  - ATEX, EEx d IIC T5 (code 9)
- Voltage: see ordering guide (voltage options)
- Stainless Steel 316 body material (code K)