

Waterworks

Hydraulic Control Valves



WW-900 Series

Engineering Data

Hydrometers - Integrated Water Meter and Valve



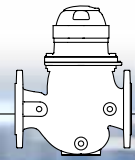

WW-900 Hydrometer

DN40 (1½") to DN250 (10")

The BERMAD Model WW-900 is a unique product integrating both a Woltman-type water meter and a diaphragm actuated hydraulic control valve, both functions working simultaneously.

A water meter, providing a full spectrum of metering functions, from simple visual readout, with pulse or analog 4 – 20 mA output for computerized data acquisition ideal for SCADA systems.

A standalone hydraulic valve with a full range of control features; On/Off, pressure reducing, sustaining, flow and level control.

- The flow metering unit is perpendicular to the pipeline and includes integral inlet and outlet flow straighteners. This internal design eliminates the need for straightening distances before and after the valve, saving valuable space especially in pit installations, this unique design enables vertical or horizontal installation whilst ensuring accuracy even when the valve is partially open during pressure or flow control tasks.
- Designed with a highly sensitive magnetic drive that provides superior accuracy meeting most water meter standards.
- The available Reed Switch and Opto-Electric 4-20 mA transmitter and pulse options provide flexibility in electrical pulse generation.
- The cover is easily unbolted for quick in-line inspection and service. All the internal assemblies can be easily removed from the valve body with no need for disassembling the valve from the line.
- A carefully balanced and peripherally supported diaphragm eliminates stress distortion, resulting in long-life and controlled actuation even under harsh conditions. One diaphragm and spring meets most of the the valve's operating pressure range requirements.
- The impeller drive is magnetically coupled to a vacuum-sealed meter register in the control head. Both the magnetic drive control head and its register(s) are hermetically sealed and are not affected by dirty water or environmental humidity.
- The series is designed to be suitable for metering and control applications in pressure management systems for effective leakage reduction.
- Advanced hydraulic design combines simple and reliable construction with superior performance and a remarkable cavitation resistance.



WW 905 Basic Valve



WW 9PM
Flow Controlled Pressure
Management Valve

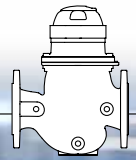

3-Way Cock Valve Local Manual Control

Solenoid Controlled

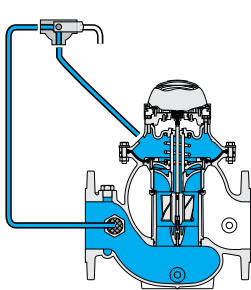

Closed

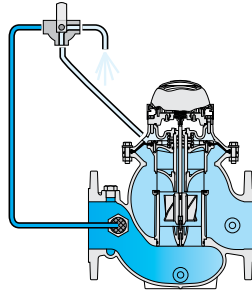

Open

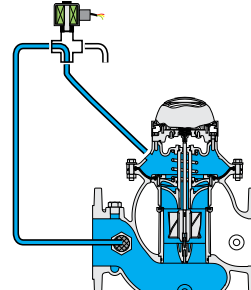

Closed

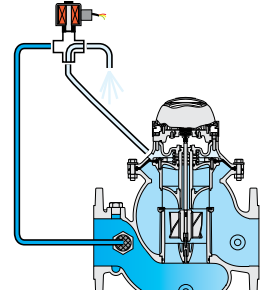

Open

Line pressure is applied to the control chamber of the hydrometer through the opened 3-way solenoid or cock valve. This creates superior hydraulic force in the control chamber that causes the valve to close and seal drip tight.

Closing the Solenoid or cock valve, discharges the line pressure from the control chamber. This in turn causes the line pressure under the plug to open the valve, and measure the flow.

2-Way Modulating Mode; Pressure Reducing Pilot

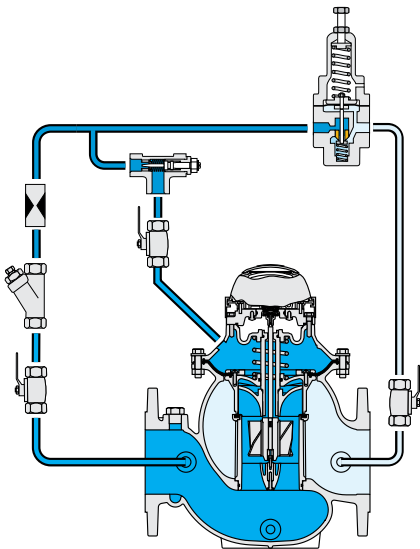

Closed

At zero flow, the closed pilot traps line pressure in the control chamber. The resulting superior force causes the valve to close and seal.

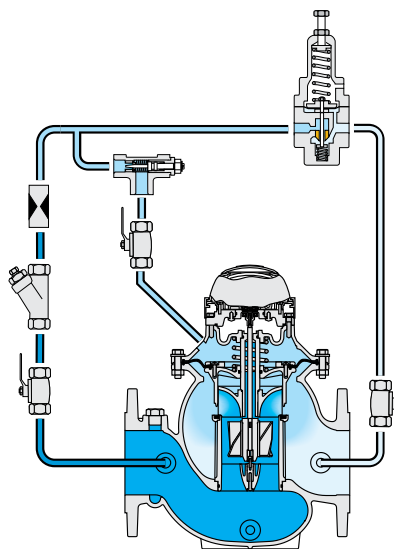

Modulating

The pilot senses line pressure changes and opens or closes accordingly. This controls the accumulated pressure in the control chamber, causing the valve to modulate to an intermediate position and maintain the preset pressure value, whilst measuring the flow.

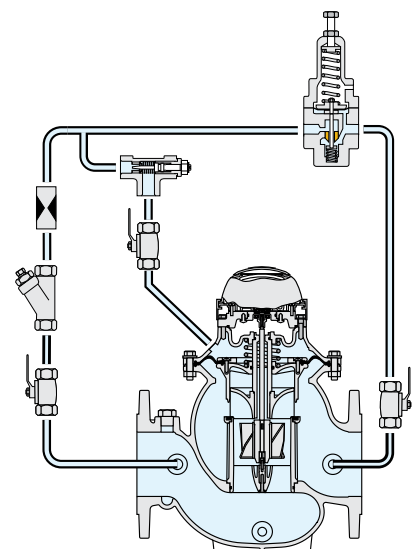

Open

When upstream pressure falls below downstream set pressure, the open pilot releases line pressure from the control chamber. The line pressure acting on the closure assembly causes the valve to open, and measure the flow.

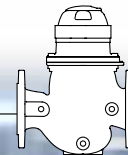

[1] Control Head

Includes: Vacuum-sealed meter register, magnetically coupled to the impeller drive, with robust brass cover. Hermetically sealed control head and register(s). High sensitivity, providing superior accuracy that meets most water meter standards. Available of Reed Switch and Opto-Electric pulse readers (4 - 20mA optional with converter).



[2] Valve Cover

Locates, centralizes and fastens diaphragm, spring, and impeller assembly ensuring smooth and accurate performance. Simple and light construction enables quick in-line inspection and service.



[3] Auxiliary Closing Spring

Various springs are available to meet different requirements.



[4] Closure Assembly

Combining a rugged radial disk harnessed to a flexible fiber reinforced diaphragm. The fully guided closure assembly and the carefully balanced and peripherally supported diaphragm prevent distortion and protect the elastomer, resulting in long-life and controlled actuation even under harsh conditions.



[5] Lower Flow Straightener Assembly

- [5.1] Guide** – Carries the transmission shaft, guides the closure assembly, and centralizes and tightens all internal parts.
- [5.2] Upper Flow Straightener** – Tightens the seal seat in place, straightens outlet flow, and creates mushroom-shaped flow.
- [5.3] Impeller** – Woltman-type impeller with tungsten carbide shaft tips and bearings for high, long-term accuracy and negligible wear.

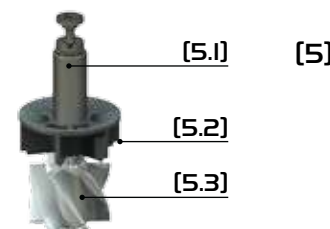

[6] Impeller Housing

- [6.1] Seal Seat** – Metal ring vulcanized with elastomeric seal, raised and distanced from valve body to prevent cavitation damage.
- [6.2] Integral V-Port** for smooth regulation and closing characteristics.
- [6.3] Lower Flow Straightener** – Straightens inlet flow, eliminating the need for straight upstream pipe required in standard water meters.

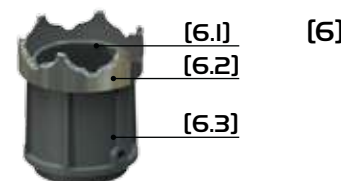

[7] Integrated Calibration Device

Enables recalibration instead of renovation when the recommended standard accuracy period has elapsed (The Calibration Device is closed with a seal).



[8] Wide Body

Hydro-dynamically designed for efficient flow with minimal pressure loss and excellent resistance to cavitation.

End Connections conform to pressure ratings and standards: ISO, ANSI, JIS, BS, and others.

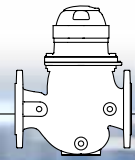

Construction Materials

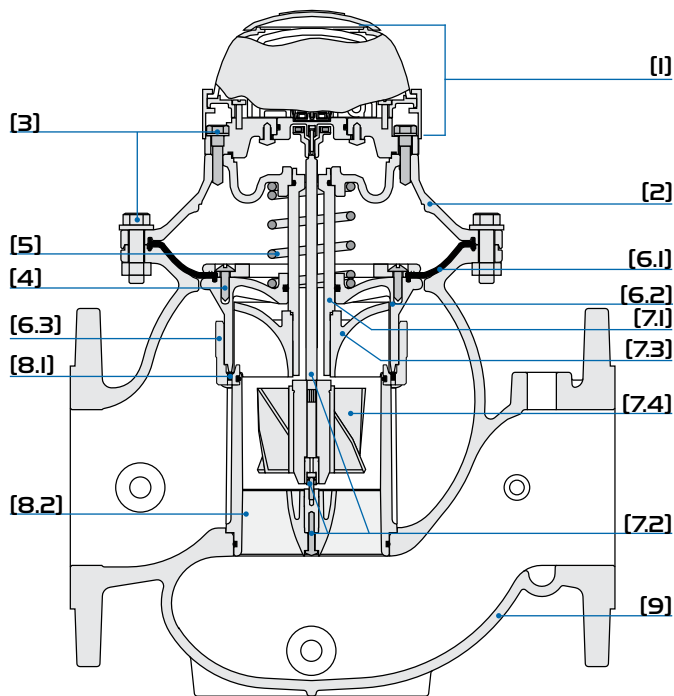

- [1] **Control Head:** Copper, Brass Reinforced Nylon, and Glass
 - [2] **Cover:** Epoxy Coated Ductile Iron to EN 1563
 - [3] **External Bolts / Nuts:** Stainless Steel 316
 - [4] **Internal Bolts, Nuts and Washers:** Stainless Steel 304 and 316
 - [5] **Spring:** Stainless Steel 302
 - [6] **Closure Assembly:**
 - [6.1] **Diaphragm:** Synthetic Rubber
 - [6.2] **Closure:** Glass Reinforced Nylon
 - [6.3] **V-Port:** Stainless Steel 304
 - [7] **Impeller Assembly:**
 - [7.1] **Guide:** 2" Pa12, 3&4" PVDF, 6-10" 303 Stainless Steel
 - [7.2] **Pivots, Bearings, and Thrust Bearings:** Tungsten Carbide
 - [7.3] **Upper flow Straightener:** Glass Fiber Reinforced Nylon
 - [7.4] **Impeller:** Polypropylene
 - [8] **Impeller Housing Assembly:**
 - [8.1] **Seal Seat:** Synthetic Rubber
 - [8.2] **Impeller Housing and Lower Flow Straightener:** Glass Fiber Reinforced Nylon
 - [9] **Valve Body:** Epoxy Coated Ductile Iron to EN 1563
- O-Rings:** Synthetic Rubber
Coating: Epoxy Fusion Bonded, Blue, 250 micron

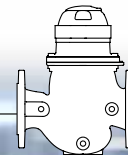

Technical Specifications

Available Sizes:

DN40 - DN250 (1½" - 10")

Pattern: Globe

End Connections:

DN40 - DN50 (1½" - 2") - Threaded

DN80 - DN250 (1½" - 10") - Flanged

DN80 - DN150 (1½" - 6") - Grooved

Connections Standard:

Flanged: ISO 7005-2 (PN10 & 16, other standards available)

Threaded: Rp ISO 7/1 (BSP.P) or NPT

Pressure Rating: PN16

Operating Pressure Ranges:

PN10: 0.7-10 bar

PN16: 0.7-16 bar

For lower pressure requirements, consult factory

Temperature: Water up to 50°C

Register Type Pulse Per Size Range	Reed Switch - Single				Reed Switch - Double	
	10 liter	100 liter	1 m ³	10 m ³	10 liter+ 1000 liter	100 liter + 10 m ³
DN40-DN100	■	■	■		■	
DN150-DN250		■	■	■		■

Register Type Pulse Per Size Range	Opto-Electric		Opto-Electric + Reed Switch - Combined			
	1 liter	10 liter	1 liter (Opto) + 100 liter (Reed)	1 liter (Opto) + 1 m ³ (Reed)	10 liter (Opto) + 1 m ³ (Reed)	10 liter (Opto) + 10 m ³ (Reed)
DN40-DN100	■		■	■		
DN150-DN250		■			■	■

Pulse Electric Data:

Reed-Switch: Switching voltage: 48 VAC/DC max

Switching current: 0.2A max

Switching power: 4W max

Opto-Electric: Supply voltage: 5-12 VDC

Output type: complementary

Output current: 200 mA

Analog Output: Supply Voltage 24VDC

Output: 4-20mA

Input: Opto-Electric

Accuracy Table

	Accuracy	DN40	DN50	DN65	DN80	DN100	DN150	DN200	DN250
Q1 Minimum Flow (m ³ /h)	+ 5%	0.8	0.8	0.8	1.3	2	4	6.3	6.3
Q2 Transitional Flow (m ³ /h)	+ 2%	1.3	1.3	1.3	2	3.2	6.5	10	10
Nominal Flow (m ³ /h)	+ 2%	15	15	15	40	60	150	250	400
Q3 Permanent Flow (m ³ /h)	+ 2%	25	25	25	63	100	250	400	400
Q4 Maximum Flow (m ³ /h) Short Time)	+ 2%	31	31	31	80	125	313	500	500
Q2/Q1	-	1.6	1.6	1.6	1.6	1.6	1.6	16	1.6
Q3/Q1	-	31.5	31.5	31.5	50	50	63	63	63
Class	OIML.R.49: EN 14154:2005								

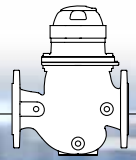

SI Metric

Globe Pattern

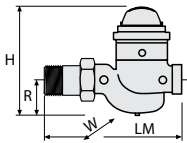
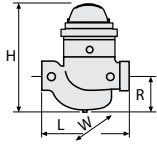

Connection Type	Threaded	
Size	DN40	DN50
L (mm)	250	250
LM (mm)	317	327
W (mm)	137	137
H (mm)	270	277
R (mm)	95	95
Weight (kg)	7.2	7.3

Globe Pattern

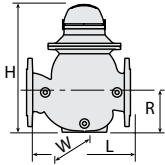

Connection Type	Flanged	
Size	DN40	DN50
L (mm)	250	250
W (mm)	150	165
H (mm)	293	300
R (mm)	96	96
Weight (kg)	10.2	11.7

Connection Type	Flanged	
Size	DN80	DN100
L (mm)	300	350
W (mm)	210	250
H (mm)	382	447
R (mm)	123	137
Weight (kg)	23.0	31.0

Connection Type	Flanged		
Size	DN150	DN200	DN250
L (mm)	500	600	600
W (mm)	380	380	405
H (mm)	602	617	617
R (mm)	216	228	228
Weight (kg)	71.0	93.0	140.5

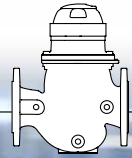

(Flow Chart - 900 (V Port))

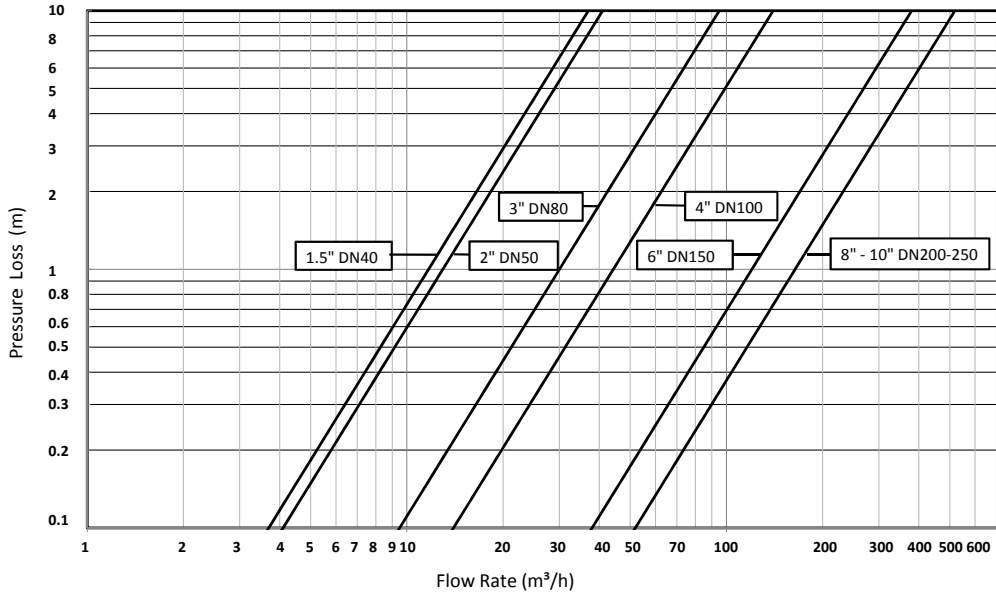

Size	DN40	DN50	DN80	DN100	DN150	DN200	DN250
kv	37	40	95	140	380	520	520
K	3	6.2	7.2	8	5.5	9.36	23
Leq - m	5.7	14.5	29	41.8	47.5	108	320

Differential pressure at a given flow, $\Delta p = \left(\frac{Q}{Kv}\right)^2$
 Where:

- Kv = Valve flow coefficient (flow in m³/h at 1bar Diff. Press.)
- Q = Flow rate (m³/h)
- ΔP = Differential pressure (bar)

Flow resistance or Head loss coefficient, $K = \Delta H \frac{2g}{V^2}$
 Where:

- K = Flow resistance or Head loss coefficient (dimensionless)
- ΔH = Head loss (m)
- V = Nominal size flow velocity (m/sec)
- g = Acceleration of gravity (9.81 m/sec²)

Equivalent Pipe Length, Leq $Leq = Lk \cdot D$

- Where:
- Leq = Equivalent nominal pipe length (m)
 - Lk = Equivalent length coefficient for turbulent flow in clean commercial steel pipe (SCH 40)
 - D = Nominal pipe diameter (m)

Note:
 The Leq values given are for general consideration only.

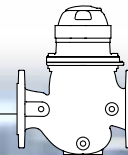

US English

Available Sizes:

1½" - 10"

End Connections:

1½" - 2" - Threaded

1½" - 10" - Flanged

1½" - 4" - 6" Grooved

Pattern: Globe

Connections Standard:

Flange: ANSI B16.42 (Ductile Iron)

Thread: NPT

Pressure rating: Ductile Iron - ANSI Class #150

Operating Pressure Range: 7-250 psi

Temperature: Water up to 122°F

Output Electrical Data:

Reed-Switch: Switching Voltage 48 VAC/DC max

Switching current: 200 mA max

Switching power: 4W max

Connector: Two conductors, Wire lead, 4' cable

Opto-Electric: Supply Voltage 5-12 VDC

Output type: Complementary

Output current: 200 mA

Connector: Three conductors, Wire lead, 4' cable

Connections: Red wire - Positive (+)

Black wire - Negative (-)

White wire - Sensor

Analog Output: Supply Voltage: 24VDC

Output: 4-20 mA

Input: Opto-Electric (See table below)

Digital flow display: 0 - 1,999 gpm 1½" - 4"

0 - 19,999 gpm 6" - 10"

Output Options:

Register Type Pulse Per Size Range	Reed Switch - Single				Reed Switch - Double	
	1 gallon	10 gallon	100 gallon	1000 gallon	1 gallon + 100 gallon	10 gallon + 1000 gallon
1½" - 4"	■	■	■		■	
6" - 10"		■	■	■		■

Register Type Pulse Per Size Range	Opto-Electric		Opto-Electric and Reed Switch combined			
	0.1 gallon	1 gallon	0.1 Gallon (Opto) +1 gallon (Reed)	0.1 Gallon (Opto) +10 gallon (Reed)	1 Gallon (Opto) +100 gallon (Reed)	1 Gallon (Opto)+ 1000 gallon (Reed)
1½" - 4"	■		■	■		
6" - 10"		■			■	■

Register Type Pulse Per Size Range	Pulse to Analog 4-20 mA output converter with digital display (MDI)	
	0.1 Gallon (Opto) to Analog	1 Gallon (Opto) to Analog
1½" - 4"	■	
6" - 10"		■

Accuracy Table

	Accuracy	1½"	2"	3"	4"	6"	8"	10"
Q1 Minimum Flow (gpm)	± 5%	3.5	3.5	5.3	7.9	17.7	27.7	27.7
Q2 Transitional Flow (gpm)	± 2%	5.7	5.7	13.2	19.8	44	69.6	69.6
Nominal Flow (gpm) ISO 4064-1-2002	± 2%	66	66	176	264	660	1100	1761
Q3 Permanent Flow (gpm)	± 2%	110	176	440	704	1100	1761	1761
Q4 Maximum Flow (gpm) Short Time	± 2%	136	220	550	880	1378	2201	2201
Q2/Q1	-	1.6	1.6	2.5	2.5	2.5	2.5	2.5
Q3/Q1	-	50	50	83	89	63	63	63
ISO 4064-1-2002 Class	-	A	A	B	B	B	B	B

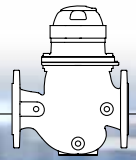

Dimensions and Weights

Connection Type	Threaded		Flanged		Flanged				
Size	1½"	2"	1½"	2"	3"	4"	6"	8"	10"
L (inch)	9 ^{13/16}	9 ^{13/16}	9 ^{13/16}	9 ^{13/16}	11 ^{13/16}	13 ^{3/4}	19 ^{11/16}	23 ^{5/8}	23 ^{5/8}
W (inch)	5 ^{3/8}	5 ^{3/8}	6 ^{1/2}	5 ^{14/16}	8 ^{1/4}	9 ^{13/16}	14 ^{15/16}	14 ^{15/16}	15 ^{15/16}
H (inch)	10 ^{5/8}	10 ^{15/16}	11 ^{13/16}	11 ^{9/16}	15 ^{1/16}	17 ^{5/8}	23 ^{11/16}	24 ^{5/16}	24 ^{5/16}
R (inch)	3	3 ^{3/4}	3 ^{3/4}	3 ^{3/4}	4 ^{13/16}	5 ^{3/8}	8 ^{1/2}	9	9
Weight (lb)	15.9	16.1	26	22.5	50.7	66.1	154.3	220.8	309.1

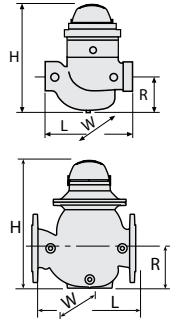

Flow Properties

Size	1½"	2"	3"	4"	6"	8"	10"
Cv	43	46	110	160	440	600	600
K	3	4.7	7.2	8.3	5.5	9.4	23
Leq feet	19.7	36.7	95	144.4	157.5	360.9	1059.7

$$\Delta P = \left(\frac{Q}{Cv}\right)^2 G_f$$

Where:

Cv = Valve flow coefficient (flow in gpm at Diff. Press. 1psi)
 Q = Flow rate (gpm)
 ΔP = Differential pressure (psi)
 G_f = Liquid specific gravity (Water=1.0)

$$K = \Delta H \frac{2g}{V^2}$$

Where:

K = Flow resistance or Head loss coefficient (dimensionless)
 ΔH = Head loss (feet)
 V = Nominal size flow velocity (feet/sec.)
 g = Acceleration of gravity (2.18 feet/sec²)

$$Leq = Lk \cdot D$$

Where:

Leq = Equivalent nominal pipe length (feet)
 Lk = Equivalent length coefficient for turbulent flow in clean commercial steel pipe (SCH 40)
 D = Nominal pipe diameter (feet)

Flow Chart - 900 V Port

