

## Pump Suction Pressure Control Valve

### Model 43T-PS

The BERMAD model 43T-PS is an elastomeric, line pressure operated pump suction head control valve, specifically designed for advanced fire protection systems and the latest industry standards.

The 43T-PS is used to control and sustain pump suction pressure at the pump inlet at an adjustable preset minimum value. This ensures a continued pressure supply to systems sharing the same supply line as well as preventing cavitation damage.

Due to exceptional reliability, fail safe opening, fast reaction and low head loss, the 43T-PS is highly suited for fire pump discharge pressure control applications.

As an option the 43T-PS can be fitted with a valve position indicator that can include a limit switch.



(for illustration only)

### Benefits and Features

- Safety and reliability
  - Obstacle-free, uninterrupted flow path
  - Time-proven, simple, fail-safe actuation
  - Single piece, rugged, elastomeric diaphragm seal – VRSD technology
  - No mechanical moving parts
- High performance
  - Very low head loss - allows maximum pump capacity
  - High flow capacity
  - Rated for PN 25bar/365 psi
  - Straight-through-flow Y-type body
  - Accurate pressure control within 5% of setting
- Specifically-designed for fire protection
  - Face-to-face length standardized to ISO 5752, EN 558-1
  - Meets the requirements of the industry standards
- Quick and easy maintenance
  - In-line serviceable
  - Fast and easy cover removal

### Typical Applications

- Maintaining minimum suction head to a booster pump
- Over draw prevention in shared supply lines
- Prevention of pump cavitation damage

### Approvals



Det Norske Veritas  
Type Approval



ABS  
American Bureau of Shipping  
Type Approval



Lloyd's Register  
Type Approval

### Additional Features

- High Build epoxy coating
- Linear valve position indicator
- Opening and/or closing speed control
- Large control filter

## Standby

The BERMAD 43T-PS will remain fully open whilst the pump suction head or pressure level [4] at the pump inlet remains above the preset minimum.

fig 1. Standby

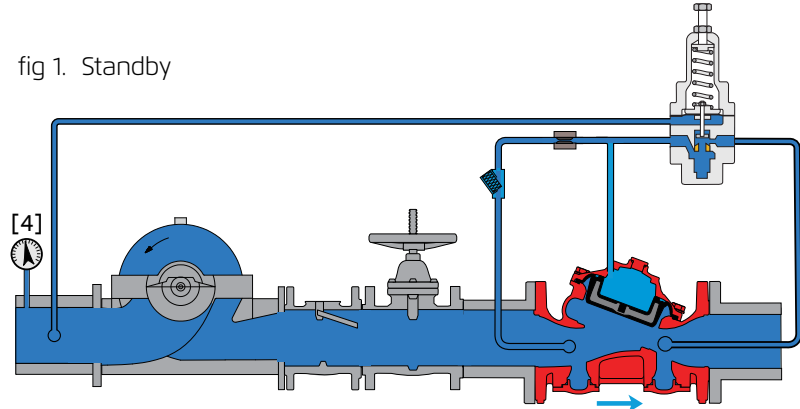

## Modulating

If the suction head pressure level falls below the preset minimum, the pilot valve [2] will sense this via the sensing line [5] and will throttle, causing upstream pressure to accumulate in the valve control chamber [6] through a restrictor [3], and thereby modulating the main valve [1].

As the valve starts to modulate, the pump suction pressure will increase. When the minimum suction pressure is returned the pilot will either cease to throttle further or modulate the main valve maintaining suction head pressure above the preset minimum.

fig 2. Modulating

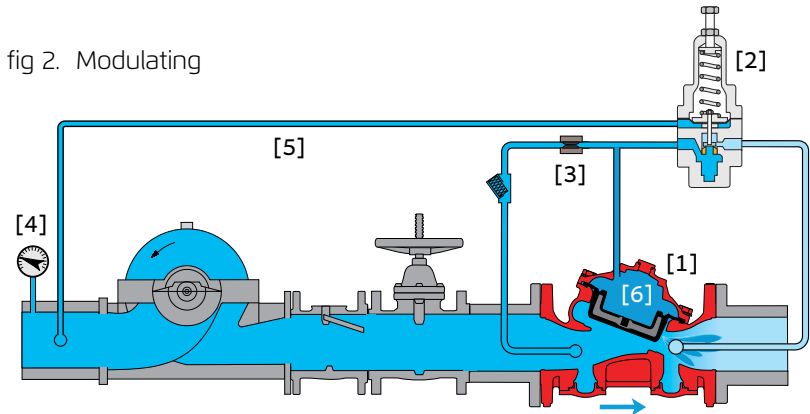

## System P&ID

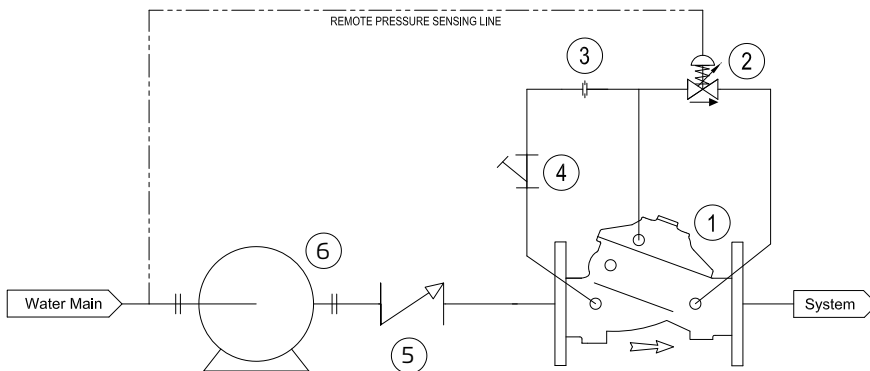

### Components

1. BERMAD 400Y water control valve
2. Pilot valve
3. Restriction orifice/needle valve
4. Y control filter
5. Pump check valve
6. Booster Pump

## System Installation

A typical installation of the BERMAD model 43T-PS is where the valve is installed downstream of the pump with a pressure sensing line leading from the valve to the pump intake or suction pipe.

The 43T-PS is especially suited for this function, as it has an exceptionally high flow capacity. Therefore when pump suction pressure is available and above the pre-set minimum the 43T-PS will be fully open, presenting minimal pressure loss for delivering the maximum possible volume of water to the fire event.

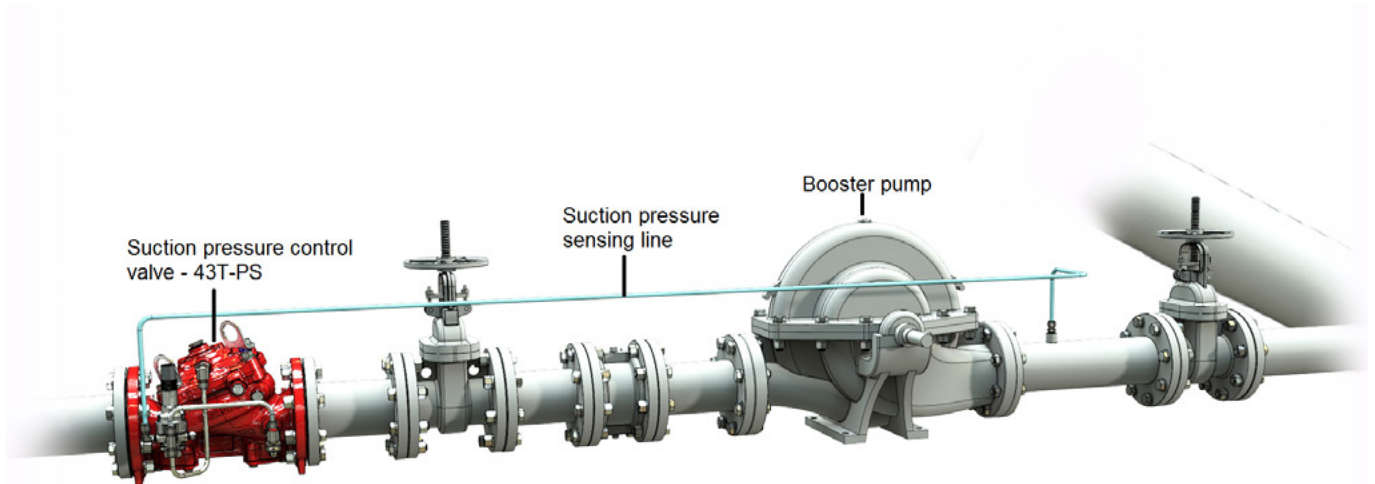

(for illustration only)

## Engineering Specifications

The Pump Suction Pressure Control Valve shall be of the elastomeric type.

The valve shall maintain a minimum set pump suction pressure regardless of system demand.

Valve actuation shall be accomplished by a single-piece, rolling diaphragm bonded with a rugged radial seal disk that shall be the only moving part.

The valve shall have an obstacle free unobstructed flow-path, with a straight-through Y-type body.

The cover and valve body shall be coated internally and externally with a high build corrosion resistant epoxy coating. Removing the valve cover for inspection or maintenance shall be inline and shall not require complete removal of the control trim.

The valve and its entire control trim shall be supplied pre-assembled and hydraulically tested by a factory certified to ISO 9000 and 9001 standards.

# BERMAD Fire Protection

43T-PS

## Pump Suction Valve

### Technical Data

#### Available Sizes (inch)

- Flanged - 1½, 2, 3, 4, 6, 8, 10, 12, 14 & 16"
- Grooved - 1½, 2, 3, 4, 6 & 8"
- Threaded - 1½ & 2"

#### Pressure Rating

- ANSI#150 - 16 bar / 235psi
- ANSI#300 - 1½" to 10" 25 bar / 365 psi  
12" to 16" 20 bar / 300 psi
- Grooved/Threaded - 25 bar / 365 psi
- Pressure setting range: 0.3 – 1.7 bar / 5 - 25 psi  
Factory setting to: 0.7 bar / 10 psi

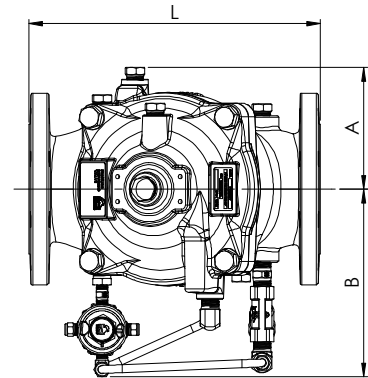
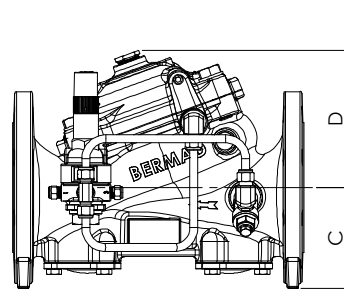

#### Elastomer

- HTNR - Fabric Reinforced High Temperature Compound - See engineering data

Valve Size	1½" DN40		2" DN50		3" DN80		4" DN100		6" DN150		8" DN200		10" DN250		12" DN300		14" DN350		16" DN400	
	mm	in	mm	in	mm	in	mm	in	mm	in	mm	in	mm	in	mm	in	mm	in	mm	in
L <sup>(1)</sup>	230	9.1	230	9.1	310	12.2	350	13.8	480	18.9	600	23.6	730	28.7	850	33.5	980	38.6	1100	43.3
L <sup>(2)</sup>	230	9.1	238	9.4	326	12.8	368	14.5	506	19.9	626	24.6	730	28.7	888	35	980	38.6	1100	43.3
A	77.5	3	77.5	3	100	3.94	115	4.53	140	5.51	172	6.77	204	8	242	9.53	242	9.53	242	9.53
B	155	6.1	155	6.1	251	9.88	266	10.47	372	14.65	490	19.29	490	19.29	656	25.83	656	25.83	656	25.83
C	64	2.52	77	3.03	106	4.17	121	4.76	140	5.51	172	6.77	204	8.03	247	9.72	272	10.71	316	12.44
D	120	4.69	120	4.69	146	5.75	158	6.22	228	9	295	11.65	296	11.65	441	17.36	441	17.36	415	16.3
Kv / Cv <sup>(4)</sup>	68 / 79		80 / 92		190 / 219		345 / 398		790 / 912		1160 / 1340		1355 / 1565		2370 / 2737		2850 / 3292		3254 / 3758	
Leq <sup>(3)</sup> : m/ft	2 / 7		5 / 16		7 / 23		9 / 30		15 / 49		27 / 89		62 / 203		52 / 171		59 / 194		88 / 289	
Kg/lb flanged#150/ISO16	17.9 / 39.4		19.3 / 42.5		34 / 74.8		44 / 95.8		87.3 / 192		150 / 331		180 / 397		323 / 712		356 / 784		403 / 886	

Notes: <sup>(1)</sup> Refers to the length dimensions for Raised Face ANSI #150, ISO 16 Flanged, Threaded and Grooved valves

<sup>(2)</sup> Refers to the length dimensions for Raised Face ANSI #300 and ISO 25 Flanged valves

<sup>(3)</sup> Leq (Equivalent Pipe Length) refers to a fully opened valve with turbulent flow in new steel pipe schedule 40, values given for general consideration only

<sup>(4)</sup> Kv/Cv values given for a fully opened valve

<sup>(5)</sup> Exact dimensions for the trim envelope may vary with specific component positioning

### Valve Code Designations

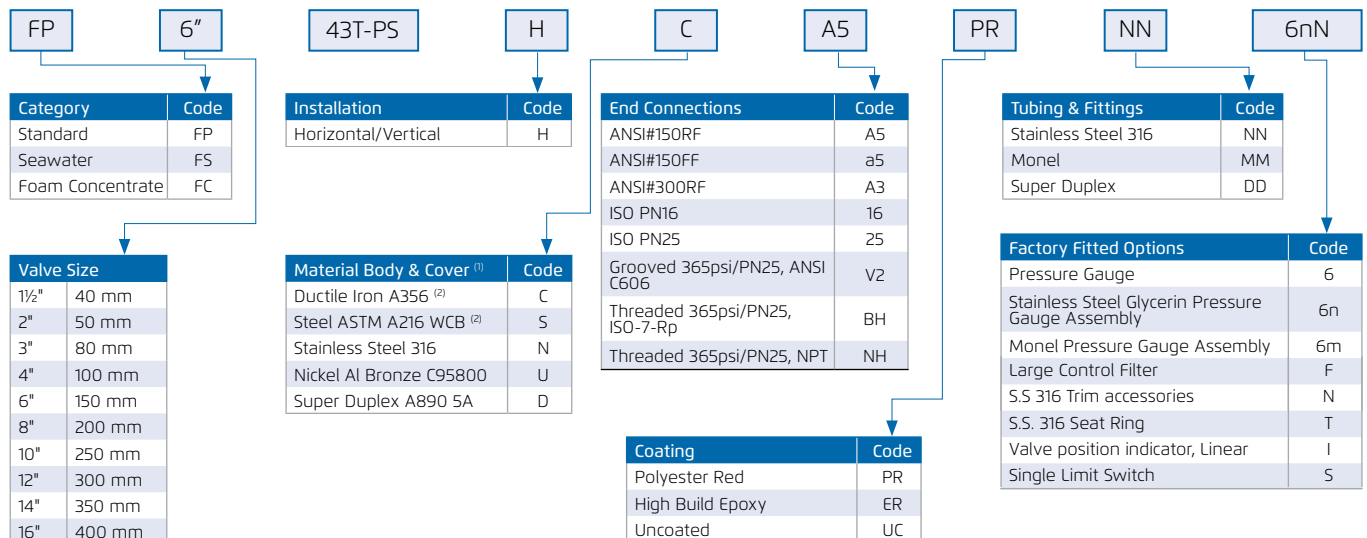

#### Notes:

<sup>(1)</sup> Other materials available see engineering data

<sup>(2)</sup> Coated internally and externally



www.bermad.com

The information contained herein may be changed by BERMAD without notice. BERMAD shall not be held liable for any errors.

June 2018

© Copyright 2008-2018 BERMAD CS Ltd.