

### On-Off Modes

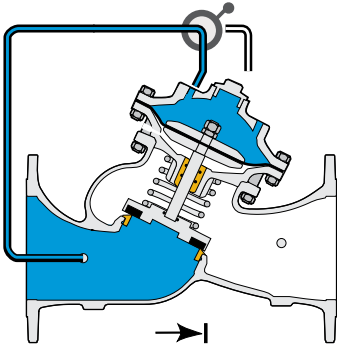

#### Closed Position

Line pressure applied to the upper control chamber of the valve creates a superior force that moves the valve to the closed position and provides drip-tight sealing.

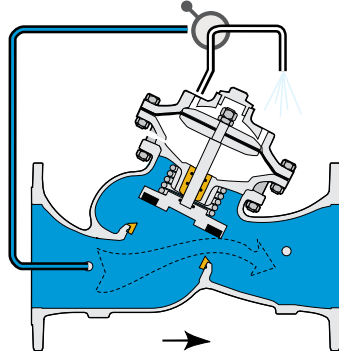

#### Open Position

Discharging the pressure in the upper control chamber to atmosphere or some other lower pressure zone causes the line pressure acting on the seal-disk to move the valve to the open position.

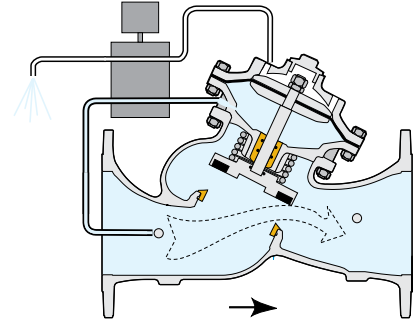

#### Powered Open Position

Line pressure is applied to the lower control chamber as pressure in the upper control chamber is vented. This, together with the line pressure acting on the seal-disk, creates a force that powers the valve to the open position.

### Modulating Mode

#### Pressure Reducing

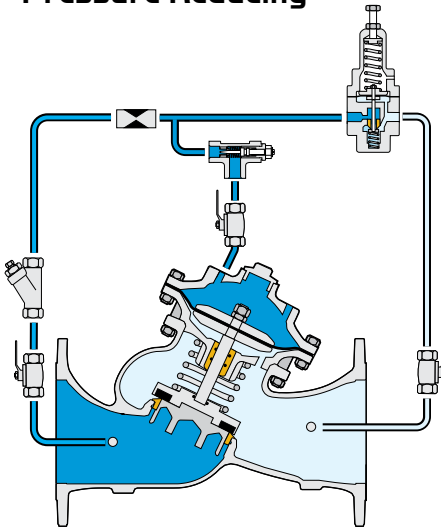

#### Closed Position

The closed adjustable pilot valve traps line pressure in the upper control chamber. The resulting superior force moves the valve to the fully closed position and provides drip-tight sealing.

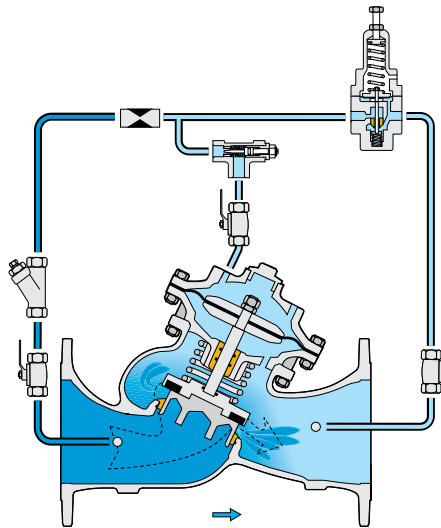

#### Modulating Position

The pilot valve senses line pressure changes and opens or closes accordingly. It controls the accumulated pressure in the valve upper control chamber, causing main valve to modulate to an intermediate position and maintain the preset pressure value.

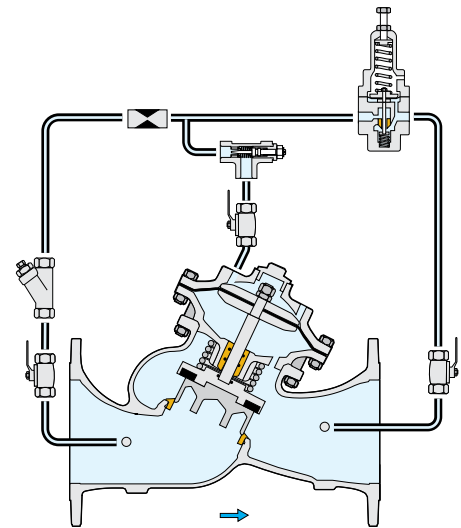

#### Open Position

The open pilot valve releases line pressure from the upper control chamber. The line pressure acting on both the lower control chamber and the seal-disk, moves the valve to the open position.

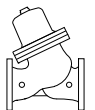

\* All text written above is valid for both 700 and 800 Series.

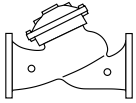
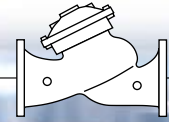

### 700 ES Series

#### Available Sizes & Patterns

- DN 40 - DN 600 (1½" - 24") - Y Pattern

#### Pressure Rating

- PN 25 (according to connection rating)

#### Connection Standard

- Flanged: ISO 7005-2 (ISO 10, 16 & 25)

#### Water Temperature

- Up to 80°C

#### Standard Materials

- **Main valve body and cover**  
Ductile iron to EN 1563 or ASTM A-536
- **Main valve internals**  
Stainless steel, bronze & epoxy coated steel
- **Control Trim**  
Stainless steel, Brass, bronze accessories  
Stainless steel 316 fittings & tubing
- **Elastomers**  
Synthetic Rubber
- **Coating**  
Blue fusion bonded epoxy

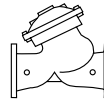

### 700 EN Series

#### Available Sizes & Patterns

- DN 50 - DN 300 (2" - 12") - Y Pattern

#### Pressure Rating

- PN 25 (according to connection rating)

#### Connection Standard

- Flanged: ISO 7005-2 (ISO 10, 16 & 25)

#### Water Temperature

- Up to 80°C

#### Standard Materials

- **Main valve body and cover**  
Ductile iron to EN 1563 or ASTM A-536
- **Main valve internals**  
Stainless steel, bronze & epoxy coated steel
- **Control Trim**  
Stainless steel, Brass, bronze accessories  
Stainless steel 316 fittings & tubing
- **Elastomers**  
Synthetic Rubber
- **Coating**  
Blue fusion bonded epoxy

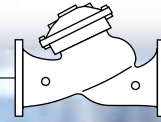

## Flow Charts

700-ES

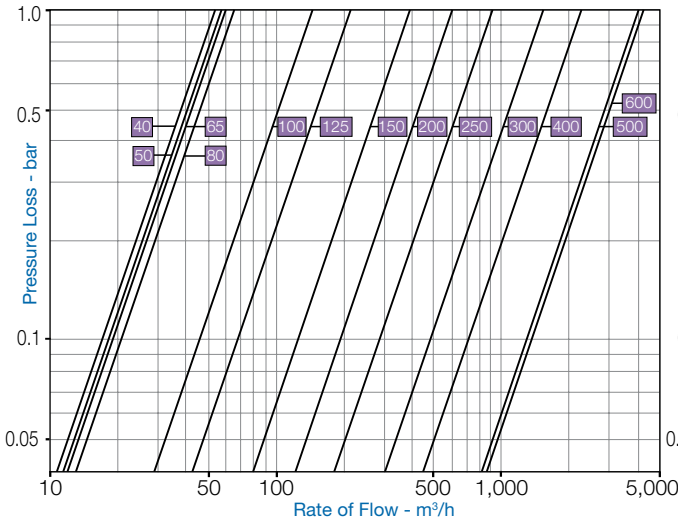

700-EN, 700, 800

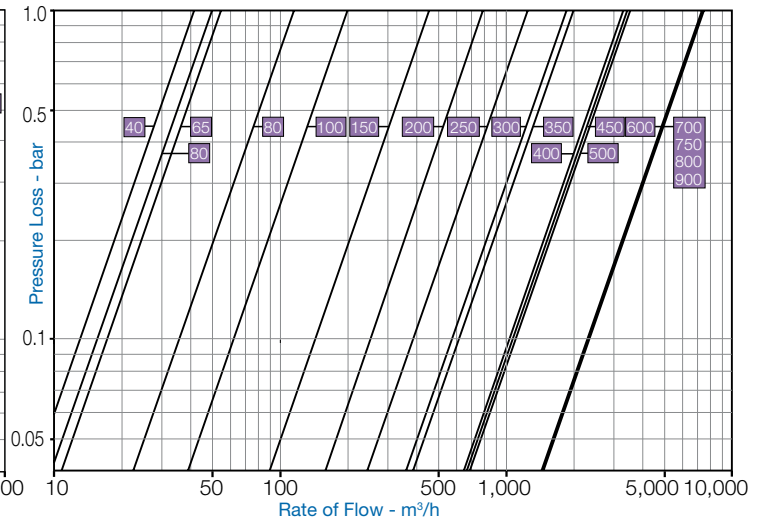

## Flow Properties

700-ES		mm	40	50	65	80	100	125	150	200	250	300	400	500	600
		inch	1.5"	2"	2.5"	3"	4"	5"	6"	8"	10"	12"	16"	20"	24"
Y-Pattern Flat Disc	Kv		54	57	60	65	145	215	395	610	905	1,520	2,250	4,070	4,275
	Cv		62	66	69	75	168	248	456	705	1,046	1,756	2,600	4,703	4,938
Y-Pattern U-Plug	Kv		46	48	51	55	123	183	336	519	769	1,292	2,027	3,460	3,634
	Cv		53	55	59	64	142	211	388	599	888	1,492	2,341	3,996	4,197

700-EN / 700 / 800		mm	40	50	65	80	100	150	200	250	300	350	400	450	500
		inch	1.5"	2"	2.5"	3"	4"	6"	8"	10"	12"	14"	16"	18"	20"
Y-Pattern Flat Disc	Kv		42	50	55	115	200	460	815	1,250	1,850	1,990	3,310	3,430	3,550
	Cv		49	58	64	133	230	530	940	1,440	2,140	2,300	3,820	3,960	4,100
Y-Pattern V-Port	Kv		36	43	47	98	170	391	693	1,063	1,573	1,692	2,814	2,916	3,018
	Cv		41	49	54	113	200	450	800	1,230	1,820	1,950	3,250	3,370	3,490
Angle Flat Disc	Kv		46	55	61	127	220	506	897	1,375	2,035	2,189	3,641	3,773	NA
	Cv		53	64	70	146	250	580	1,040	1,590	2,350	2,530	4,210	4,360	NA
Angle V-Port	Kv		39	47	51	108	187	430	762	1,169	1,730	1,861	3,095	3,207	NA
	Cv		45	54	59	124	220	500	880	1,350	2,000	2,150	3,580	3,710	NA

700 Large Diameter		mm	600	700	750	800	900
		inch	24"	28"	30"	32"	36"
G-Pattern Flat Disc	Kv		7,350	7,500	7,500	7,500	7,500
	Cv		8,490	8,670	8,670	8,670	8,670

Valve flow coefficient, Kv or Cv

$$Kv(Cv) = Q \sqrt{\frac{G_f}{\Delta P}}$$

Where:

Kv = Valve flow coefficient (flow in m³/h at 1bar Diff. Press.)

Cv = Valve flow coefficient (flow in gpm at Diff. Press. 1psi)

Q = Flow rate (m³/h ; gpm)

ΔP = Differential pressure (bar ; psi)

Gf = Liquid specific gravity (Water = 1.0)

$$Cv = 1.155 Kv$$

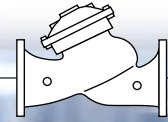

### Cavitation

#### Cavitation

The cavitation phenomenon has a significant affect on control valve and system performance. Cavitation may damage the valve and piping by the affects of erosion and vibration. Cavitation also generates noise and may limit and ultimately choke the flow.

As the pressure differential across the valve increases, the static pressure of the flow passing through the throttling area of the valve (Vena Contracta) drops sharply.

When the fluid's static pressure reaches liquid vapor pressure, vapor cavities (bubbles) form and grow until they violently implode by the recovered pressure downstream to the valve seat.

The implosion of these cavities generates high-pressure surges, micro jets and intensive heat, which erode valve components and downstream piping. In its final stage, cavitation flashes and chokes the flow.

The Cavitation Guide is based on the formula commonly used in the valve industry:

$$\sigma = (P2 - Pv) / (P1 - P2)$$

#### Where:

$\sigma$  = Sigma, cavitation index, dimensionless

P1 = Upstream pressure, absolute

P2 = Downstream pressure, absolute

Pv = Liquid vapor pressure, absolute

(Water, 18°C = 0.02 bar-a ; 65°F = 0.3 psi-a)

Use these guides and your applications upstream and downstream pressures to determine whether their intersection lies in or out of the cavitation damage zone.

Considerations to avoid cavitation damage:

- A) Reduce system pressure in stages designing each pressure stage to be above cavitation conditions.
- B) Consider using other valve selection criteria
  - a. Valve body and plug type
  - b. Valve size
  - c. Valve material

#### Notes:

1. An alternate cavitation index formula introduced by ISA is:  
 $\sigma_{ISA} = (P1 - Pv) / (P1 - P2)$  which equals  $\sigma + 1$
2. The above charts should be considered only as a general guide.
3. For optimum system and control valve application please consult Bermad.

#### Cavitation Guide

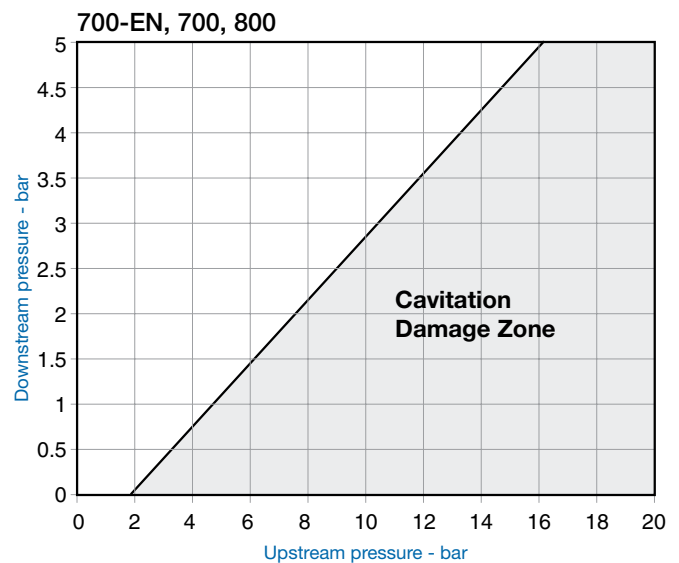
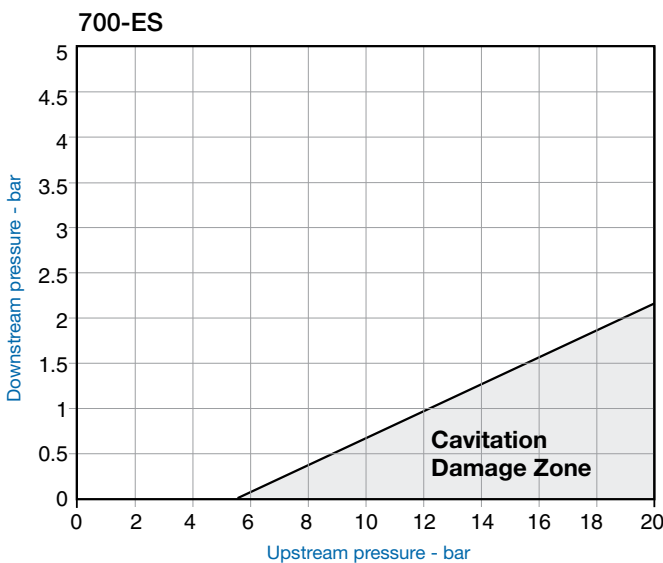

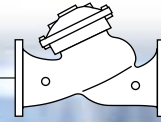

## Dimensions & Weights

## 700-ES Series

### Flanged

#### 700-ES Series

##### Y Pattern



	DN	40	50	65	80	100	125	150	200	250	300	400	500	600
ISO PN 10; 16; 25	L*	230	230	290	310	350	400	480	600	730	850	1,100	1,250	1,450
	W	150	165	185	200	235	270	300	360	425	530	626	838	845
	h	80	90	100	105	125	142	155	190	220	250	320	385	435
	H	240	250	250	260	320	375	420	510	605	725	895	1,185	1,235
	Weight (Kg)	10	10.8	13.2	15	26	40	55	95	148	255	436	1,061	1,173

\* Length according to EN 558-1

#### 700-EN Series

##### Y Pattern

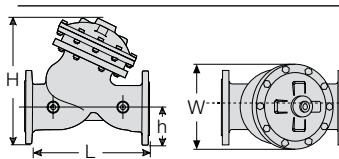

	DN	50	80	100	150	200	250	300
ISO PN 10; 16; 25	L*	230	310	350	480	600	730	850
	W	165	200	235	320	390	480	550
	h	82.5	100	118	150	180	213	243
	H	244	305	369	500	592	733	841
	Weight (Kg)	9.7	21	31	70	115	198	337

\* Length according to EN 558-1

#### 700 Series - Large Diameter

##### G Pattern

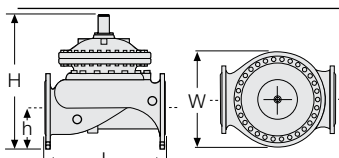

	DN	600	700	750	800	900		DN	600	700	750	800	900
ISO PN 10; 16	L*	1,450	1,650	1,750	1,850	1,850	ISO PN 20; 25	L*	1,500	1,650	1,750	1,850	1,850
	W	1,250	1,250	1,250	1,250	1,250		W	1,250	1,250	1,250	1,250	1,250
	h	470	490	520	553	600		h	470	490	520	553	600
	H	1,965	1,985	2,015	2,048	2,095		H	1,965	1,985	2,015	2,048	2,095
	Weight (Kg)	3,250	3,700	3,900	4,100	4,250		Weight (Kg)	3,500	3,700	3,900	4,100	4,250

\* Length according to EN 558-1

### Threaded

#### Angle Pattern

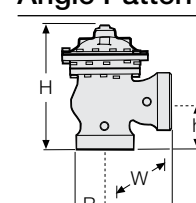

	DN	50	65	80
BSP; NPT	L	121	140	159
	W	122	122	163
	R	40	48	55
	h	83	102	115
	H	225	242	294
	Weight (Kg)	5.5	7	15

#### Y Pattern

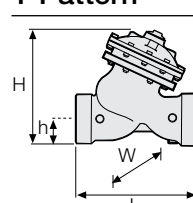

	DN	40	50	65	80
BSP; NPT	L	155	155	212	250
	W	122	122	122	163
	h	40	40	48	56
	H	201	202	209	264
	Weight (Kg)	5.5	5.5	8	17

### Control Chamber Displacement Volume (liter)

DN	40	50	65	80	100	125	150	200	250	300	350	400	450	500	600-900
700-ES Series	0.125	0.125	0.125	0.125	0.3	0.45	0.5	2.15	4.5	8.5	N/A	12.4	N/A	29.8	29.8
700-EN Series	N/A	0.125	N/A	0.3	0.45	N/A	2.15	4.5	8.5	12.4	N/A	N/A	N/A	N/A	N/A