

Electro-Pneumatic, Pressure Control Deluge Valve with Local Reset

Model FP 400Y - 6DC - H

The BERMAD Model 400Y-6DC-H is an elastomeric, hydraulic line pressure operated deluge valve, designed specifically for advanced fire protection systems and the latest industry standards.

The 400Y-6DC-H is activated by a fall in pneumatic pressure caused either by the activation of a sprinkler in the dry pilot line or by an electric signal to the 3 way solenoid valve. The 6DC-H can also be activated remotely either pneumatically or electrically. Once open the 6DC-H latches in the open position, until locally reset.

When open an integrated pressure reducing pilot valve regulates the main valve to maintain a precise, stable, pre-set downstream pressure. The optional valve position indicator can include a limit switch suitable for Fire & Gas monitoring systems.

The 400Y-6DC-H is ideal for open-nozzle systems with a high pressure water supply. It is available with electrical components to suit any hazardous location.



(for Illustration Only)

Benefits and Features

■ Safety and reliability

- Time-proven, simple, fail-safe actuation
- Single-piece, rugged, elastomeric diaphragm seal-VRSD technology
- Obstacle-free, uninterrupted flow path
- No mechanical moving parts
- Shuts off on remote command
- Ensures precise, stable downstream water pressure
- Valve position limit switches (optional)

■ High performance

- Very high flow efficiency
- Straight-through-flow Y-type body
- Approved for PN25/365psi

■ Designed for fire protection

- Face-to-face length standardized to ISO 5752, EN 558-1
- Meets the requirements of industry standards

■ Quick and easy maintenance

- In-line serviceable
- Fast and easy cover removal
- Swivel mounted drain valves*

* not including 1½" & 2" valves

Typical Applications

- Fusible plug loop systems
- Automatic water spray systems
- Foam applications
- Corrosive water supplies
- High pressure water supply
- Dual redundant detection system

Approvals



UL-Listed
Special System Water Control
Valves, Deluge Type (VLFT)
Sizes 1½" - 16"



Det Norske Veritas
Type Approval



ABS
American Bureau of Shipping
Type Approval



Lloyd's Register
Type Approval

Additional Features

- Valve position limit switches
- Drain Valve/s Inlet/Outlet
- Air Maintenance Device
- Alarm pressure switch
- Water motor alarm

BERMAD Fire Protection

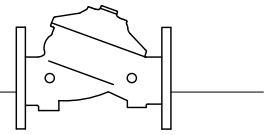

Model FP 400Y - 6DC - H

400Y Series

Operation

(for Illustration Only)

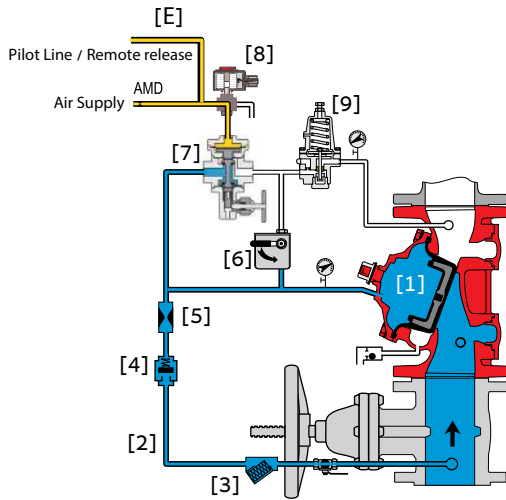

Valve Closed (set position)

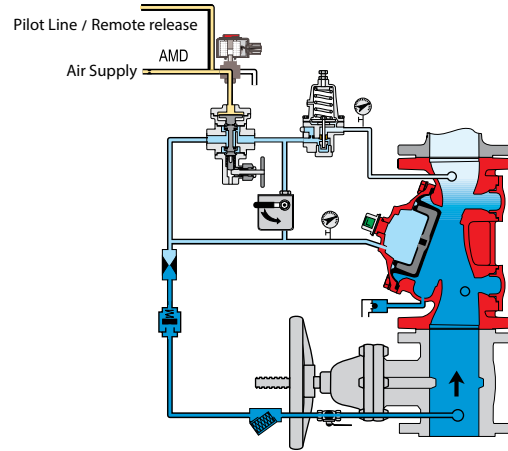

Valve Open (operating condition)

The BERMAD model 400Y-6DC-H is held closed by water pressure in the control chamber [1]. Upon release of pressure from the control chamber, the valve opens.

Under NORMAL conditions, water pressure is supplied to the control chamber via the priming line [2] and strainer [3], restriction orifice [5] and is then trapped in the control chamber by a check valve [4], manual emergency release [6], and a relay valve (URV-M) [7] that is held closed by pneumatic pressure supplied through a three-way solenoid valve [8]. The water pressure trapped in the main valve control chamber holds the diaphragm against the valve seat, sealing it drip-tight and keeping the system pipes dry.

Under FIRE conditions, water pressure is released from the control chamber, either with the manual emergency release, or by the URV-M opening automatically.

The URV opens in response either to a decrease in pneumatic pilot-line pressure [E] or to the solenoid valve being activated by the fire & gas control system [C]. This opens the 400Y-6DC-H deluge valve, allowing water to flow into the system piping and to the alarm device.

Once open the 400Y-6DC-H latches open until reset locally.

The pressure-reducing pilot valve [9] modulates the main valve to maintain the set outlet pressure.

When outlet pressure changes, the pressure-reducing pilot opens or closes in response. This regulates the pressure in the main valve's control chamber, thus modulating the position of the diaphragm seal disk to maintain the set outlet pressure.

System P&ID

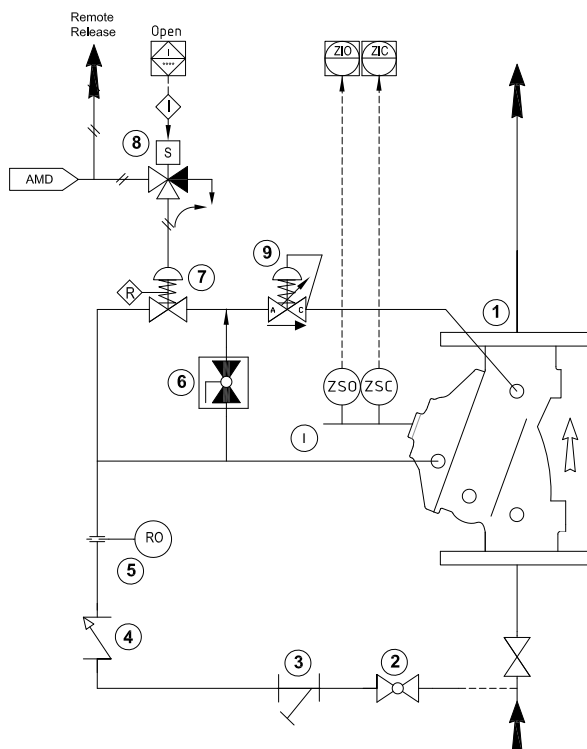

Components

- 1 BERMAD 400Y Deluge Valve
- 2 Priming Ball Valve
- 3 Priming Strainer
- 4 Check Valve
- 5 Restriction Orifice
- 6 Manual Emergency Release
- 7 URV-2-M Relay Valve
- 8 3-Way NC Solenoid Valve
- 9 Pressure Reducing Pilot Valve

Optional System Items

- ZS Limit Switch Assembly
- AMD Air Maintenance Device
- I Valve Position Indicator

See also Factory Fitted Options under the Valve Code Designations on the last page



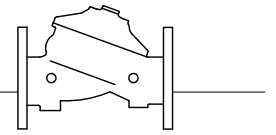

System Installation

A typical installation of the BERMAD model 400Y-6DC-H features automatic actuation via a pneumatic universal relay valve, triggered by a fusible plug loop. It can also be triggered electrically by a signal from a fire & gas control system or an on-site emergency pushbutton. Once open the relay pilot URV-M will latch mechanically keeping the 400Y-6DC-H open, until locally reset. A pressure reducing pilot valve integrated in the trim ensures precise, pre-set, stable downstream water pressure.

When fitted with a limit switch the valve can send a feedback signal to a remote valve position monitoring system.

Optional System Items

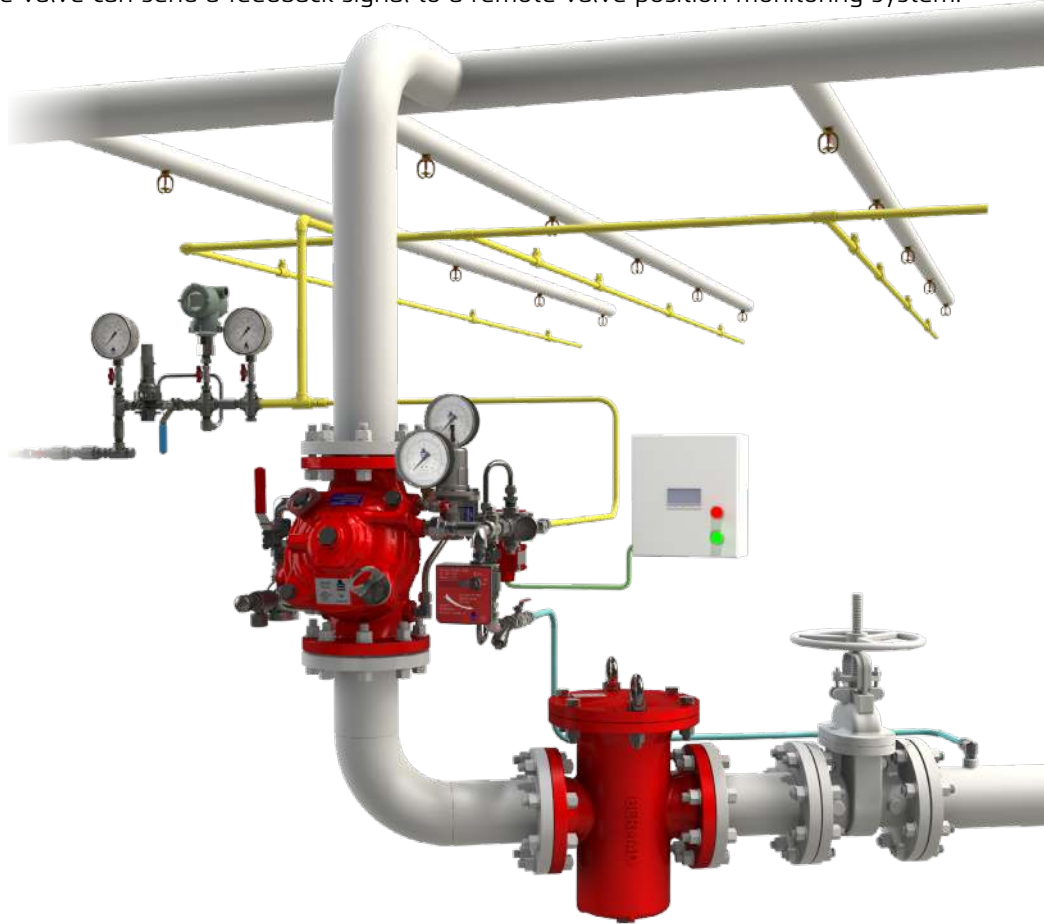
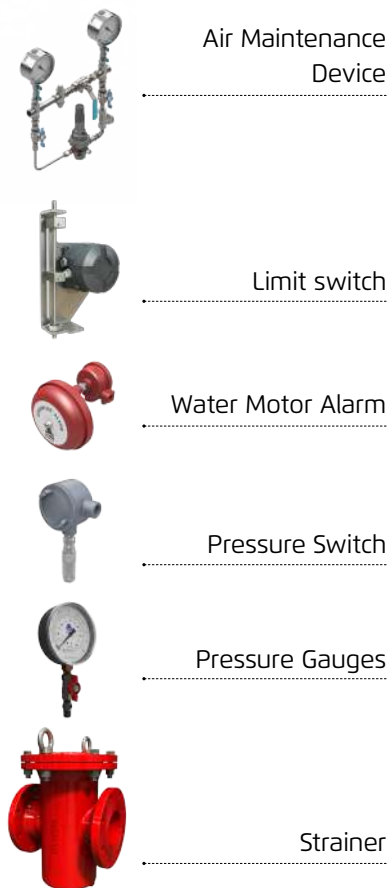

(for Illustration Only)

Suggested Specifications

The deluge valve shall be a UL-listed, 25-bar/365-psi rated, elastomeric type with a straight-through, Y-type-body.

The valve shall have an unobstructed flow path, with no stem guide or supporting ribs.

Valve actuation shall be accomplished by a single-piece, rolling diaphragm bonded with a rugged radial seal disk. The diaphragm assembly shall be the only moving part.

The deluge valve shall include a latching relay pilot valve, a 3-Way solenoid valve with a tolerance of 35% below the rated voltage, a pressure reducing pilot valve, a Y-type strainer, a ball drain valve, an automatic drip-check with manual override, 4-inch pressure gauges, and a manual emergency release housed in a stainless steel box.

The valve drain socket shall be flanged and have a 360 degree swivel.

The valve shall be equipped with two limit switches.

Removing the valve cover for inspection and maintenance shall be in-line and not require removal of the control trim.

The deluge valve and its entire control trim shall be supplied pre-assembled and hydraulically tested by a factory certified to ISO 9000 and 9001 standards.

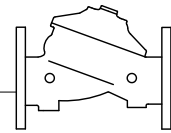

Technical Data

Available Sizes (inch)

- Flanged - 1½, 2, 3, 4, 6, 8, 10, 12, 14 & 16"
- Grooved - 1½, 2, 3, 4, 6 & 8"
- Threaded - 1½ & 2"

Pressure Rating

- ANSI#150 - 16 bar / 235 psi
- ANSI#300 - 1½" to 10" 25 bar / 365 psi
12" to 16" 20 bar / 300 psi
- Grooved/Threaded - 25 bar / 365 psi
- Setting range: 4 - 12 bar (60 - 175 psi)

Elastomer

- HTNR - Fabric Reinforced High Temperature Compound - See engineering data

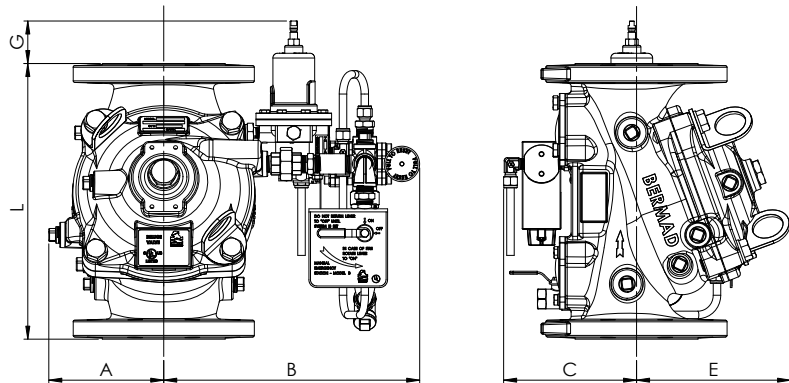

Size	1½" DN40		2" DN50		3" DN80		4" DN100		6" DN150		8" DN200		10" DN250		12" DN300		14" DN350		16" DN400	
Units	mm	in	mm	in	mm	in	mm	in	mm	in	mm	in	mm	in	mm	in	mm	in	mm	in
L ⁽¹⁾	230	9.1	230	9.1	310	12.2	350	13.8	480	18.9	600	23.6	730	28.7	850	33.5	980	38.6	1100	43.3
L ⁽²⁾	230	9.1	238	9.4	326	12.8	368	14.5	506	19.9	626	24.6	730	28.7	888	35	980	38.6	1100	43.3
A	84	3.3	84	3.3	144	5.7	152	6	205	8	235	9.3	235	9.3	348	13.1	348	13.1	348	13.1
B	294	11.6	294	11.6	352	13.9	351	13.8	417	16.4	445	17.6	445	17.6	558	22	558	22	558	22
C	122	4.8	122	4.8	166	6.5	162	6.4	140	5.5	172	6.8	204	8	242	9.5	270	10.6	310	12.2
ØD	¾"		¾"		1½"		2"		2"		2"		2"		2"		2"		2"	
E	120	4.7	120	4.7	146	5.7	158	6.2	228	9.0	295	11.6	295	11.6	441	17.4	441	17.4	415	16.3
G	78	3.1	78	3.1	68	2.7	55	2.2	6.5	0.3	-	-	-	-	-	-	-	-	-	-
Kv / Cv ⁽⁴⁾	68 / 79		80 / 92		190 / 219		345 / 398		790 / 912		1160 / 1340		1355 / 1565		2370 / 2737		2850 / 3292		3254 / 3758	
Leq ⁽³⁾ m/ft	2 / 7		5 / 16		7 / 23		9 / 30		15 / 49		27 / 89		62 / 203		52 / 171		59 / 194		88 / 289	
Kg/lb (flanged#150/ISO16)	17.9 / 39.4		19.3 / 42.5		34 / 74.8		44 / 95.8		87.3 / 192		150 / 331		180 / 397		323 / 712		356 / 784		403 / 886	

- Notes: ⁽¹⁾ Refers to the length dimensions for Raised Face ANSI #150, ISO 16 Flanged, Threaded and Grooved valves
⁽²⁾ Refers to the length dimensions for Raised Face ANSI #300 and ISO 25 Flanged valves
⁽³⁾ Leq (Equivalent Pipe Length) refers to a fully opened valve with turbulent flow in new steel pipe schedule 40, values given for general consideration only
⁽⁴⁾ Kv/Cv values given for a fully opened valve
⁽⁵⁾ Exact dimensions for the trim envelope may vary with specific component positioning

Valve Code Designations

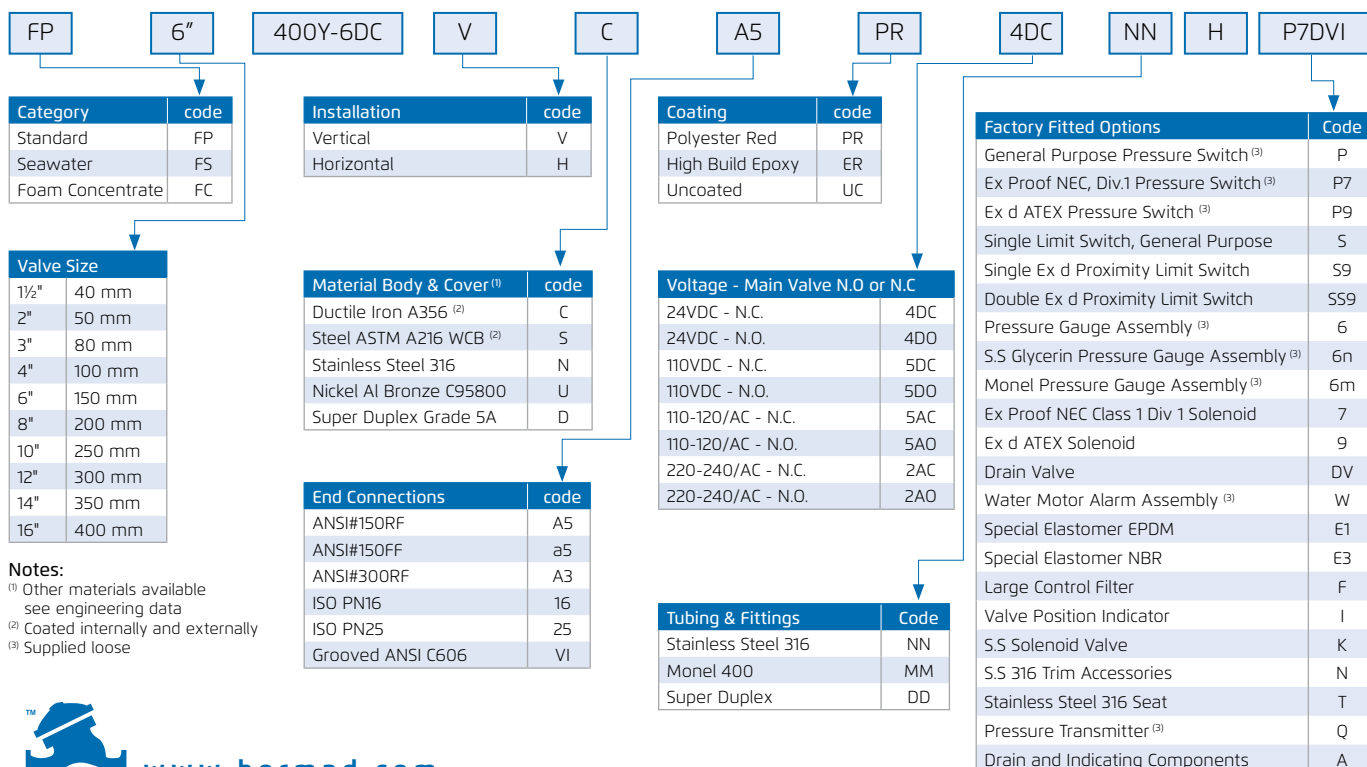

- Notes: ⁽¹⁾ Other materials available see engineering data
⁽²⁾ Coated internally and externally
⁽³⁾ Supplied loose

