

Electronic Control Valve

Model 718-03

- Pressure control
- Flow control
- Leakage control
- Level control
- Temperature control
- Mixture control at mixing junction

The Model 718-03 Electronic Control Valve combines the advantages of an excellent modulating, line pressure driven, hydraulic control valve with the advantages of electronic control. This valve responds to signals from the electronic controller BERMAD BE (optional), by changing its opening position according to the set values programmed into the controller.



Features and Benefits

- **Line pressure driven** – Independent operation
- **Solenoid controlled**
 - Low power consumption
 - Wide ranges of pressures and voltages
 - Normally Open, Normally Closed or Last Position
- **Electronic Controller compatible**
 - Local & remote modification of set values
 - Suitable for conventional PLC methods
 - Data logging
- **In-line serviceable** – Easy maintenance
- **Double chamber**
 - Full powered opening (option “B”) and closing
 - Non-slam closing characteristic
 - Protected diaphragm
- **Semi-straight flow** – Smooth flow characteristics
- **Stainless Steel raised seat** – Cavitation damage resistant
- **V-Port Throttling Plug** – Low flow stability
- **Flexible design** – Easy addition of features

Major Additional Features

- Full powered opening & closing – **718-03-B**
- Downstream over pressure guard – **718-03-48**
- Relief override – **718-03-3Q**
- Check feature – **718-03-20**
- Flow-over-the-seat (fail-safe close) – **718-03-O**

See relevant BERMAD publications.

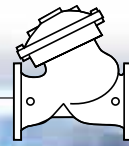

Operation

The Model 718-03 is a Electronic Control Valve equipped with two 2-Way solenoid pilots. The interaction between the two solenoids determines the required opening position as signaled by the dedicated electronic controller (optional BERMAD BE) [1]. The upstream solenoid [2] applies pressure to the upper control chamber [3] harnessing valve differential pressure to power the diaphragm actuator to a more closed position. The downstream solenoid [4] vents upper control chamber pressure resulting in a more open main valve. Needle valves [5] & [6] control the closing and opening speed of the valve. Valve position can be provided by either an optional limit switch, or an analog transducer. In cases where pipeline water is contaminated (corrosive, debris laden) external control fluid is often used. Normally closed, normally open and last position models are available. For very low pressure applications, refer to the full powered opening and closing Model 718-03-B.

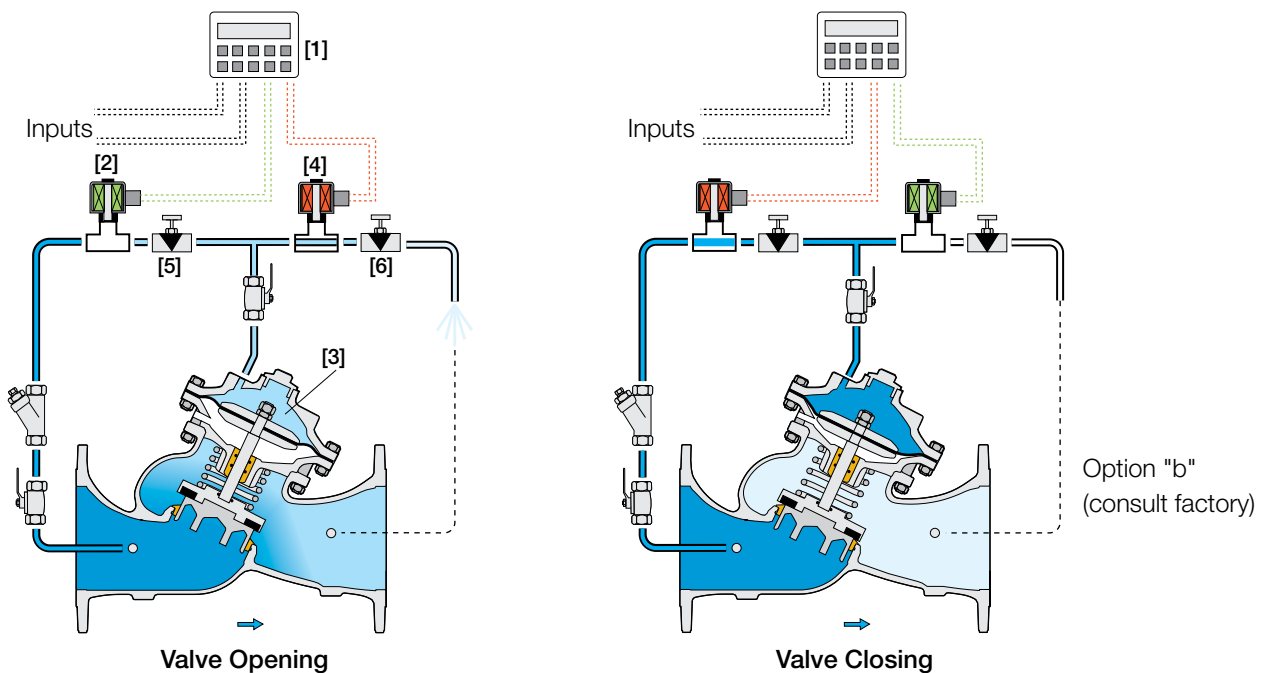

Option "b"
(consult factory)

Pilot System Specifications

718-03 control loop consists of two solenoids:

Solenoid Location	Main Valve Position		
	N.O.	N.C.	L.P.
Upstream (inlet)	N.C.	N.O.	N.C.
Downstream (outlet)	N.O.	N.C.	N.C.

Standard Materials:

Solenoids:

Body: Brass or Stainless Steel
Elastomers: NBR or FPM
Enclosure: Molded epoxy

Tubing & Fittings:

Stainless Steel 316 or Copper & Brass

Accessories:

Stainless Steel 316, Brass and Synthetic Rubber Elastomers

Solenoids Electrical Data:

Voltages:

(ac): 24, 110-120, 220-240, (50-60Hz)

(dc): 12, 24, 110, 220

Power Consumption:

(ac): 30 VA, inrush; 15 VA (8W), holding or

70 VA, inrush; 40 VA (17.1W), holding

(dc): 8-11.6W

Values might vary according to specific solenoid model

Notes:

- Inlet pressure, outlet pressure and flow rate are required for optimal sizing and cavitation analysis
- Recommended continuous flow velocity: 0.3-6.0 m/sec ; 1-20 ft/sec
- Minimum operating pressure: 0.7 bar ; 10 psi. For lower pressure requirements consult factory



Electronic Control of a Single Variable

This method is suited for those applications where dynamic control of a variable is required. The system includes a Model 718-03 Electronic Control Valve, a dedicated electronic controller (optional BERMAD BE), and an analog transducer. The controller receives continuous inputs from the analog transducer and corrects the valve opening in response to a comparison with the programmable set value. The set value can be changed either manually on the controller keyboard or remotely through PC, SMS or any other communication methods.

This system can be used for a wide range of applications including:

- Pressure control (see below)
- Flow control
- Level control

Pressure Reducing

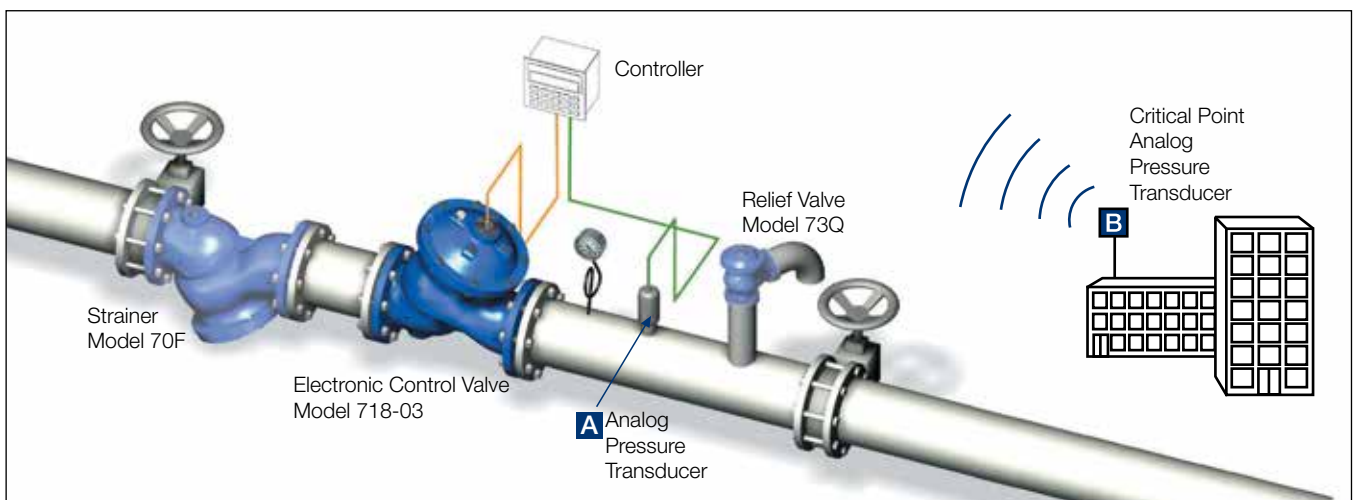

Installing the pressure transducer downstream from the valve provides a pressure reducing feature.

Either of two methods can be applied:

- Local pressure control as transmitted by pressure transducer **A**.
- Remote pressure control as transmitted by critical point pressure transducer **B**.

Pressure Sustaining

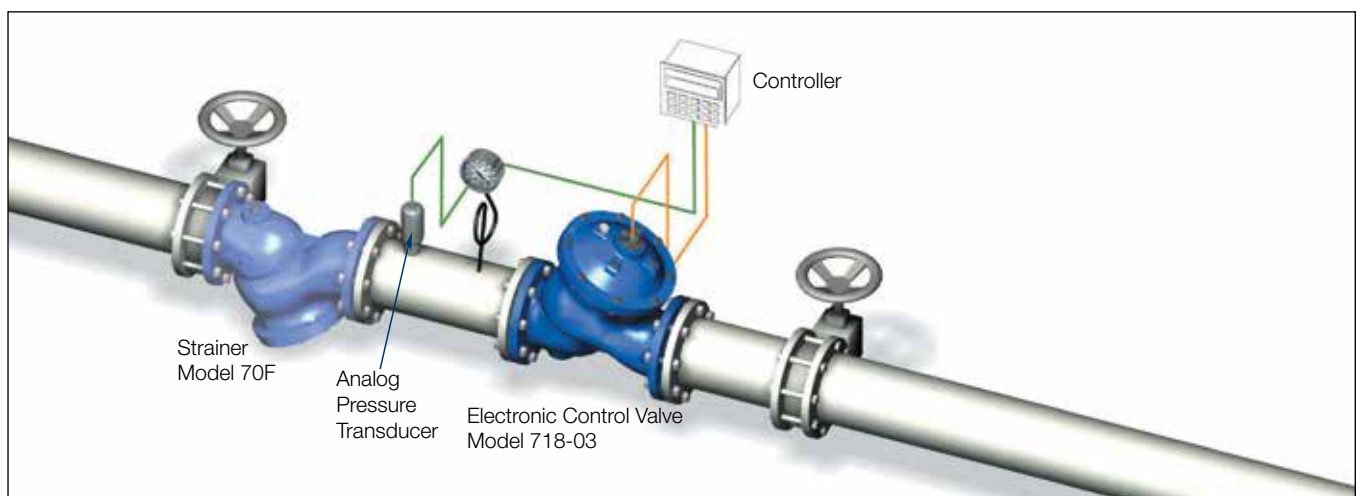

Installing the pressure transducer upstream from the valve provides a pressure sustaining feature:

- Sustaining pump discharge pressure
- Sustaining circulated discharge pressure
- Sustaining pump suction pressure
- Sustaining reservoir or canal level

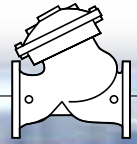

Electronic Control of Mixing Junctions

This method is suited for dynamic control of two parallel valves controlling the two separate sources of a mixing junction. These systems include two Model 718-03 Electronic Control Valves, and a dedicated electronic controller (optional BERMAD BE). Two types of systems are used.

Type A - Sampling the Mixture

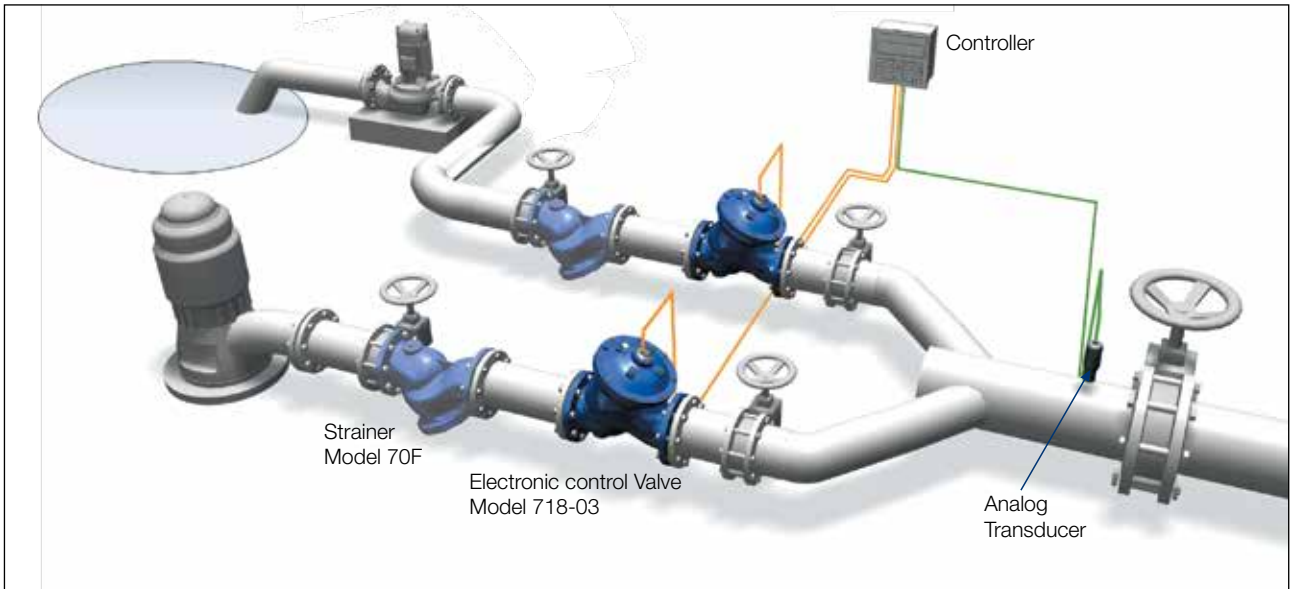

The controller receives continuous inputs from the analog transducer (conductivity, salinity, temperature etc.), and corrects, in real-time, the opening of each valve in comparison with the programmed value.

Type B - Sampling the Sources

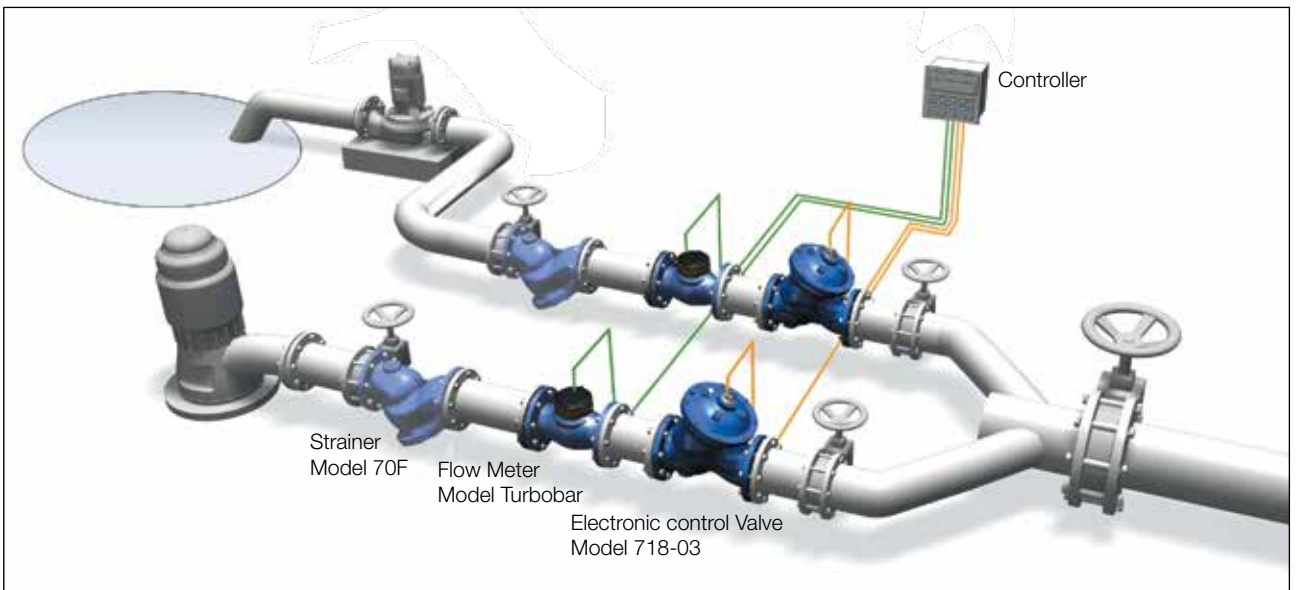

The controller receives continuous inputs from both flow transducers and corrects, in real-time, the opening of each valve, thus maintaining constant flow ratio between the two sources to achieve the desired result.

- Combination of both **Types A and B** is available also

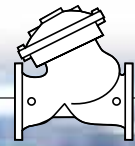

Electronic Control of a Variable as a Function of Another Variable

This control method is suitable for those applications that require dynamic control of a dependant variable as a programmable function of a governing variable. The system includes a Model 718-03 Electronic Control Valve, a dedicated electronic controller (optional BERMAD BE), and two transducers (one for each variable).

The controller receives continuous inputs from both transducers and corrects the valve opening in response to a comparison with the set value according to a programmed function.

This system can be used for a wide range of applications including:

- **Leakage control** – Pressure control as a function of flow (see below)
- **Reservoir applications** – Inlet or outlet flow control as a function of reservoir level
- **Heating and cooling systems** – Flow control as a function of temperature or ΔP

Leakage Control

Optimum network design requires active adjustment of the system set pressure to the minimum possible level.

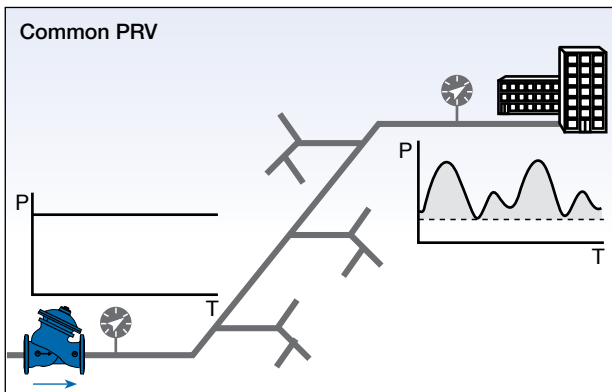

Common PRVs are set to keep the downstream pressure constant, ensuring sufficient pressure at the system critical point during “peak” demand (when line friction head loss is highest). The shaded area represents the hours and levels when pressure is higher than required.

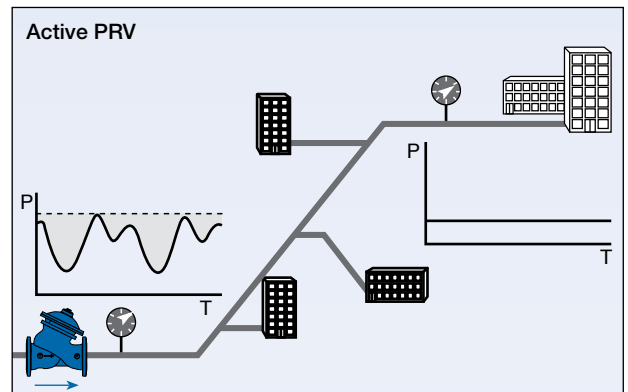

The Model 718-03 and controller continuously corrects the PRV’s set value to ensure the minimum required pressure at the system critical point. As a result, the average network pressure dramatically decreases, reducing system leakage flow, burst, maintenance, energy and chemical costs. The shaded area represents the hours and levels when leakage is reduced.

Leakage Control Installation

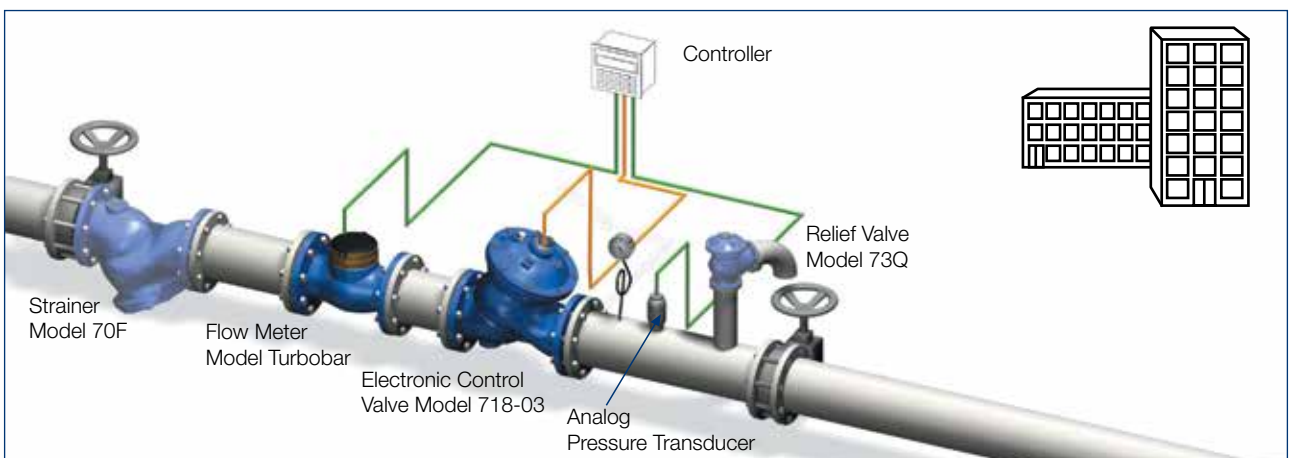

Data logging and analysis of the distribution network parameter values enable establishing a function for real time adjustment of pressure according to system demand. The flow and pressure transducers continuously transmit to the controller which reacts by adjusting the Model 718-03 according to the pre-established function.

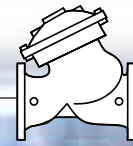

Technical Data

- Size Range:** DN40-900 ; 1 1/2-36"
- End Connections (Pressure Ratings):**
- Flanged:** ISO PN16, PN25 (ANSI Class 150, 300)
- Threaded:** BSP or NPT
- Others:** Available on request
- Valve Patterns:** "Y" (globe) & angle, globe (DN600-900 ; 24"-36")
- Working Temperature:** Water up to 80°C ; 180°F
- Standard Materials:**
- Body & Actuator:** Ductile Iron
- Internals:** Stainless Steel, Bronze & coated Steel
- Diaphragm:** Synthetic Rubber Nylon fabric-reinforced
- Seals:** Synthetic Rubber
- Coating:** Fusion Bonded Epoxy, RAL 5005 (Blue) approved for drinking water or Electrostatic Polyester Powder

Differential Pressure Calculation

$$\Delta P = \left(\frac{Q}{(Kv; Cv)} \right)^2$$

- ΔP** = Differential Pressure for fully open valve (bar; psi)
- Q** = Flow rate (m³/h; gpm)
- Kv** = Metric system - valve flow coefficient (flow in m³/h at 1 bar ΔP with 15°C water)
- Cv** = US system - Valve flow coefficient (flow in gpm at 1 psi ΔP with 60°F water)
- Cv = 1.155 Kv

Flow Data & Dimensions Table

DN / Size		40	1.5"	50	2"	65	2.5"	80	3"	100	4"	150	6"	200	8"	250	10"	300	12"	350	14"	400	16"	450	18"	500	20"	
Flow Data	700ES	Kv / Cv - Flat	54	62	57	66	60	69	65	75	145	167	395	456	610	705	905	1,045	1,520	1,756	-	-	2,250	2,599	-	-	4,070	4,701
	700EN	Kv / Cv - V-Port	46	53	48	56	51	59	55	64	123	142	336	388	519	599	769	888	1,292	1,492	-	-	1,913	2,209	-	-	3,460	3,996
	700ES	Kv / Cv - "Y" Flat	42	49	50	58	55	64	115	133	200	230	460	530	815	940	1,250	1,440	1,850	2,140	1,990	2,300	3,310	3,820	3,430	3,960	3,550	4,100
	700EN	Kv / Cv - "Y" V-Port	36	41	43	49	47	54	98	113	170	200	391	450	693	800	1,063	1,230	1,573	1,820	1,692	1,950	2,814	3,250	2,916	3,370	3,018	3,490
700-ES	PN16; 25	L (mm / inch)	230	9.1	230	9.1	290	11.4	310	12.2	350	13.8	480	18.9	600	23.6	730	28.7	850	33.5	-	-	1,100	43.3	-	-	1,250	49.2
		W (mm / inch)	150	5.9	165	6.5	185	7.3	200	7.9	235	9.3	300	11.8	360	14.2	425	16.7	530	20.9	-	-	626	24.6	-	-	838	33
		h (mm / inch)	80	3.1	90	3.5	100	3.9	105	4.1	125	4.9	155	6.1	190	7.5	220	8.7	250	9.8	-	-	320	12.6	-	-	385	15.2
		H (mm / inch)	240	9.4	250	9.8	250	9.8	260	10.2	320	12.6	420	16.5	510	20.1	605	23.8	725	28.5	-	-	895	35.2	-	-	1,185	46.7
700-EN	PN16; 25	Weight (Kg/lb)	10	22	10.8	23.8	13.2	29	15	33	26	57.2	55	121	95	209	148	326	255	561	-	-	437	960	-	-	1,061	2,334
		L (mm / inch)	-	-	-	-	-	-	310	12.2	350	13.8	480	18.9	600	23.6	730	28.7	850	33.5	-	-	-	-	-	-	-	-
		W (mm / inch)	-	-	-	-	-	200	7.9	235	9.3	320	12.6	390	15.4	480	18.9	550	21.7	-	-	-	-	-	-	-	-	-
		h (mm / inch)	-	-	-	-	-	100	3.9	118	4.6	150	5.9	180	7.1	213	8.4	243	9.6	-	-	-	-	-	-	-	-	-
700 Flanged	"Y" PN16 Class 150	H (mm / inch)	-	-	-	-	-	305	12	369	14.5	500	19.7	592	23.3	733	28.9	841	33.1	-	-	-	-	-	-	-	-	-
		Weight (Kg/lb)	-	-	-	-	-	21	46.2	31	68.2	70	154	115	253	198	436	337	741	-	-	-	-	-	-	-	-	-
		L (mm / inch)	205	8.1	210	8.3	222	8.7	250	9.8	320	12.6	415	16.3	500	19.7	605	23.8	725	28.5	733	28.9	990	39	1,000	39.4	1,100	43.3
		W (mm / inch)	155	6.1	165	6.5	178	7	200	7.9	223	8.8	320	12.6	390	15.4	480	18.9	550	21.7	550	21.7	740	29.1	740	29.1	740	29.1
700 Threaded	"Y" PN25 Class 300	h (mm / inch)	78	3.1	83	3.3	95	3.7	100	3.9	115	4.5	143	5.6	172	6.8	204	8	242	9.5	268	10.6	300	11.8	319	12.6	358	14.1
		H (mm / inch)	239	9.4	244	9.6	257	10.1	305	12	366	14.4	492	19.4	584	23	724	28.5	840	33.1	866	34.1	1,108	43.6	1,127	44.4	1,167	45.9
		Weight (Kg/lb)	9.1	20	10.6	23	13	29	22	49	37	82	75	165	125	276	217	478	370	816	381	840	846	1,865	945	2,083	962	2,121
		L (mm / inch)	205	8.1	210	8.3	222	8.7	264	10.4	335	13.2	433	17	524	20.6	637	25.1	762	30	767	30.2	1,024	40.3	1,030	40.6	1,136	44.7
700 Threaded	Angle PN16; 25 Class 150; 300	W (mm / inch)	155	6.1	165	6.5	185	7.3	207	8.1	250	9.8	320	12.6	390	15.4	480	18.9	550	21.7	570	22.4	740	29.1	740	29.1	750	29.5
		h (mm / inch)	78	3.1	83	3.3	95	3.7	105	4.1	127	5	159	6.3	191	7.5	223	8.8	261	10.3	295	11.6	325	12.8	357	14.1	389	15.3
		H (mm / inch)	239	9.4	244	9.6	257	10.1	314	12.4	378	14.9	508	20	602	23.7	742	29.2	859	33.8	893	35.2	1,133	44.6	1,165	45.9	1,197	47.1
		Weight (Kg/lb)	10	22	12.2	27	15	33	25	55	43	95	85	187	146	322	245	540	410	904	434	957	900	1984	967	2,132	986	2,174

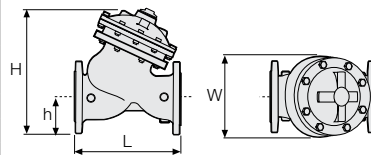

Specify when ordering:

- Size
- Main model
- Additional features
- Pattern
- Body material
- End connection
- Coating
- Voltage & main valve position
- Tubing & Fittings materials
- Operational data (according to model)
- Pressure data
- Flow data
- Reservoir level data
- Settings

* Use Bermad's Waterworks Ordering Guide

DN / Size		600	24"	700	28"	750	30"	800	32"	900	36"
Globe PN16 Class 150	L (mm / inch)	1,450	57.1	1,650	65	1,750	68.9	1,850	72.8	1,850	72.8
	W (mm / inch)	1,250	49.2	1,250	49.2	1,250	49.2	1,250	49.2	1,250	49.2
	h (mm / inch)	470	18.5	490	19.3	520	20.5	553	21.8	600	23.6
	H (mm / inch)	1,965	77.4	1,985	78.1	2,015	79.3	2,048	80.6	2,095	82.5
	Weight (Kg/lb)	3,250/7,150	3,700/8,140	3,900/8,580	4,100/9,020	4,250/9,350					
Globe PN25 Class 300	L (mm / inch)	1,500	59.1	1,650	65	1,750	68.9	1,850	72.8	1,850	72.8
	W (mm / inch)	1,250	49.2	1,250	49.2	1,250	49.2	1,250	49.2	1,250	49.2
	h (mm / inch)	470	18.5	490	19.3	520	20.5	553	21.8	600	23.6
	H (mm / inch)	1,965	77.4	1,985	78.1	2,015	79.3	2,048	80.6	2,095	82.5
	Weight (Kg/lb)	3,500/7,700	3,700/8,140	3,900/8,580	4,100/9,020	4,250/9,350					

