

BIC 100

BERMAD Irrigation Control System

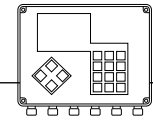

Operation Manual





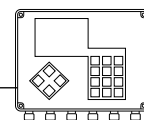

Contents

		Page
1.	General Description	03
2.	Normal Mode	
	Defining irrigation programs	04
	Selecting the Desired Program	05
	Entering into the Desired Program	05
	Defining the Irrigation Days of Programs	06
	Setting irrigation days by use of a Run-list	06
	Setting Irrigation Days by use of Cycle of Days	07
	Defining Start Times of Programs	08
	Defining the Water Valve Runtime	09
	Defining the Fertilizer Valve Runtime	10
	Adjusting the Water Runtime by %	11
	Setting the Current Time and Current Day	11
	Manual Start/Stop of Programs	12
3.	Monitoring Operation	12
4.	Filters Backflushing	13
5.	Rain Delay	14
6.	The Special Function of Program "C" Irrigation	15
7.	Initial Setup Procedure	
	How to Enter into the Setup Procedure	15
	Selecting between 24 hours clock and AM/PM clock	17
	Defining the Outputs in Use	17
8.	Defining the Dosing Units and the Mode of Setting the Irrigation Days	21
9	Connection of Outputs and Inputs to the Terminal Board	23
10	Alarm Conditions Detected by the Controller	
	Low Battery Detection	24
	No AC Power	24
	Short Circuit	24
	Endless Looping of the Backflush Program	24
11	Wiring Diagram	
	DC MODEL	25
	AC MODEL	26
12.	Technical Data	
	DC MODEL	27
	AC MODEL	27



1. General Description

- BIC 100 is a modular irrigation controller that controls up to 10 outputs. It is specially designed for agricultural applications which need no volumetric information.
- The 10 outputs are flexible and can be used for any of the following purposes:
 - » Multiple irrigation valves
 - » 1 main valve
 - » Up to 2 fertilizer injectors
 - » 1 booster pump
 - » Up to 4 backflush valves
- There are three irrigation programs: Programs A and B are started by user defined start time, and Program C can be programmed to start by a dry contact sensor or by a user defined start time. All programs can include any of the irrigation valves and fertilizer injectors and the programs can run in parallel as long as they do not create conflicts.
- Irrigation days can be set in terms of Days Cycle or in terms of a Run List in which each day of the week can be set as an irrigation day or a day off.
- Each program can have up to 6 start times that become effective on the irrigation days.
- An additional program, F, is used for controlling the filters backflush process. Backflush cycles can be triggered either by a DP (Differential Pressure) sensor or by a predefined interval.
- The unit can read 3 digital inputs for the following purposes: one for triggering the start of program C, one for the DP sensor, and one for Rain delay.
- The user interface consists of a customized LCD display and a keyboard that includes the following keys:
 - »  (ENTER) key
 - »  (ADVANCE or INCREASE) key
 - »  (GO BACK or DECREASE) key
 - »  (MANUAL) key
- BIC 100 is available in DC and AC models.
- The DC model can be powered either by 6v DC or 12v DC and activates 2 wired 12v DC latching solenoids. The voltage for the solenoids switching is stored in a capacitor and boosted by a charge pump.
- The AC model contains an internal transformer that can be powered by 110v or 220v transformed to 24v AC for powering the controller and the solenoids.
- When the BIC 100 is idle, the LCD display turns off. A double beep every 15 seconds confirms that the controller is active.
- To turn the LCD on, press and hold down any key on the keyboard.

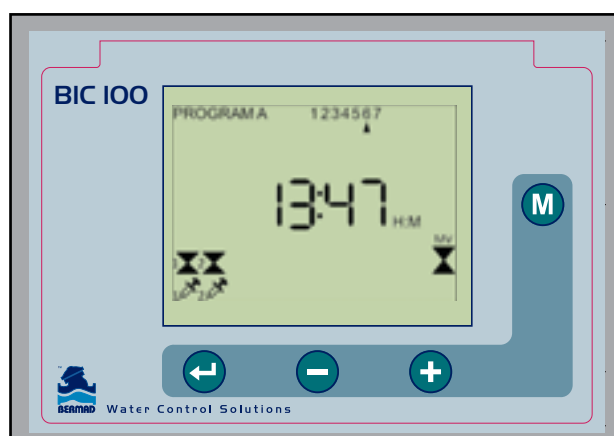

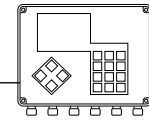

2. Normal Mode

Normal mode includes everyday activities such as - planning, activating and monitoring Irrigation, Fertigation and Backflush programs.

Before using the controller in **Normal** mode it must be set up according to the specific application. The Setup procedure is described in "Initial Setup Procedure" on page 15.

A few facts about programs:

- The system recognizes 4 programs: A, B, C and F. Programs A,B, and C are used for irrigation and program F for controlling the filters backflushing.
- Programs A and B can be started manually or by time, while program C can also be started by a sensor.
- Programs can run in parallel as long as they do not create conflict between water and fertilizers. If such a conflict occurs, priority is given to the water and the fertilizer injection pauses. While paused, the fertilizer timer continues to run and when the conflict is resolved fertilization continues.
- **The fertilizers are injected in a continuous mode. When the water runtime is longer than the Fertilizer Runtime, the difference will be divided in two** – half of the difference is used as Water Before, and the other half as Water After fertilization as illustrated in the following diagram:

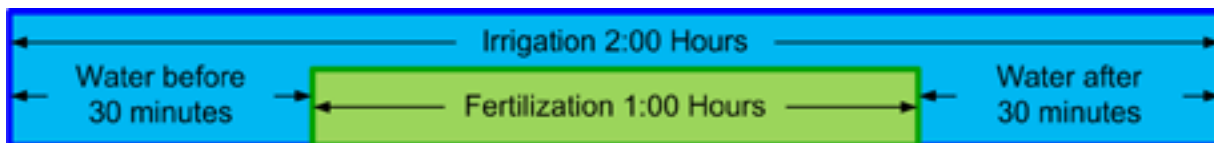

- Each program can have up to 6 start times that take effect on the days defined as irrigation days.
- Optionally, the water dosage of each irrigation program can be adjusted upward or downward by a multiplication factor of 0-250%, leaving the original dosage unchanged.

Defining irrigation programs

Defining an irrigation program consists of the following steps:

- Selecting the required program
- Defining the irrigation days
- Defining the start times
- Defining the water runtime per each valve to be included in the program
- Defining the fertilizers runtime per each valve

Use the  and  keys to move from one step to another.

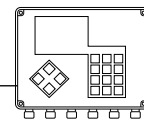

Selecting the Desired Program

How do we know we are in the right place for program selection?

- When the controller is powered on, the user should see a screen similar to the one shown below. This screen is known as the **Opening** screen. Then, by pushing the **←** key, the name of the program (A,B,C,F) starts blinking. Now use the **+** and **-** keys to move from one program to another until arriving at the desired program.

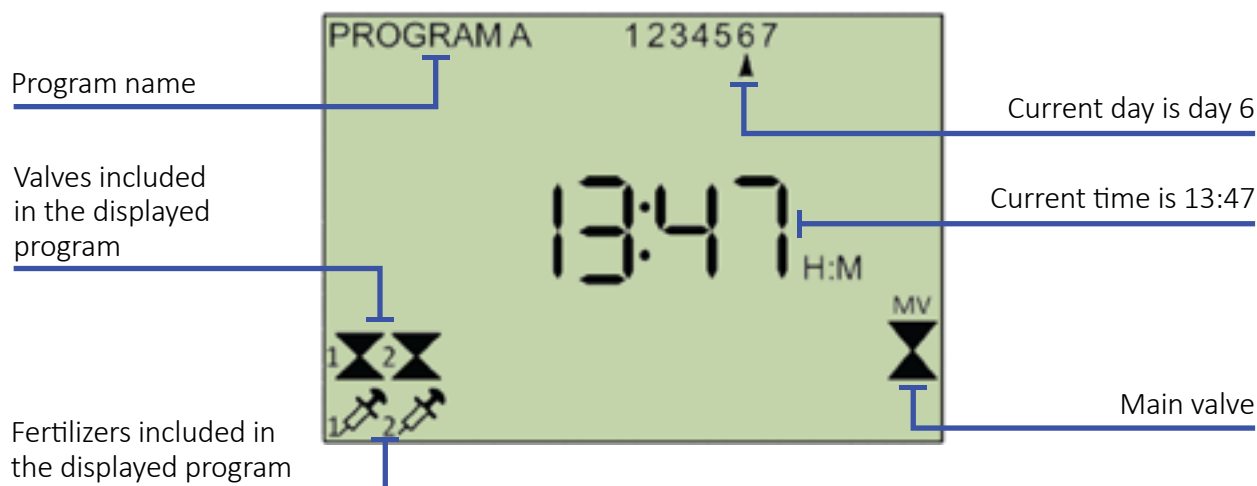

There are several ways to get to the **Opening** screen from any other screen:

- If you pass through all the steps of a program definition by using the **+** key, eventually you return to the **Opening** screen.
- You can just wait until the display turns off and then hold down the **←** key until it turns on again.
- If you hold down the **+** and **-** keys simultaneously until entering setup mode, then hold down the **←** key until returning back to Normal mode, you will arrive at the **Opening** screen.

Entering into the Desired Program

Once you are at the desired program, press the **←** key again to stop the blinking of the program's name and then you can start using the **+** or **-** to enter into the selected program, move between the fields and set the desired values.

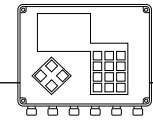

Defining the Irrigation Days of Programs

When the desired program is selected and the letter of the program's name is not blinking, use the **+** key to arrive at one of the following screens in which the word **Days** is blinking, indicating that this is now the active field:

In program A the irrigation days are planned by a run-list in which each day of the week that was selected as an irrigation day is marked by a small arrow.



In program B the irrigation days are planned by a cycle of days in which the interval between cycles is specified. In the example, program B will irrigate every 2 days.

Please see page 23 for instructions to change between cycle of days and run-lists for each program.

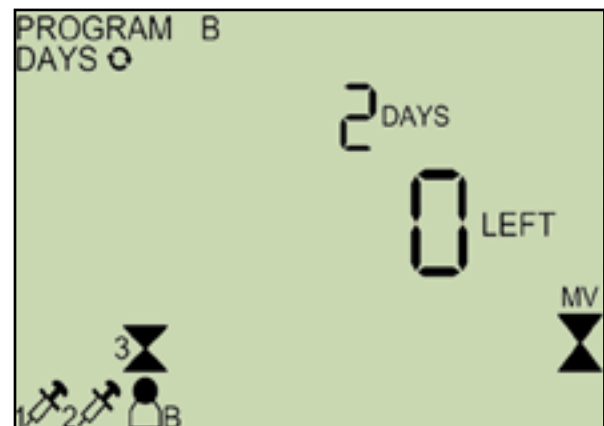

Setting irrigation days by use of a Run-list

While the word **Days** is blinking and the 7 days of the run-list are displayed, press the **+** key to start setting the active irrigation days. The procedure leads you through the seven days of the week, starting from day 1. Each day that is an irrigation day, must be marked **Yes**. If day 1 appears with a blinking **No** and you want to turn it into an active irrigation day, use the **+** key to change the **No** to **Yes** and confirm by pressing the **+** key. As a result, a small arrow appears under day 1 of the Run-list indicating that it is now an active irrigation day. If day 1 already appears with a blinking **Yes** and you want to turn it into an inactive irrigation day, press the **-** key to turn the **Yes** into **No** and confirm by pressing the **-** key.

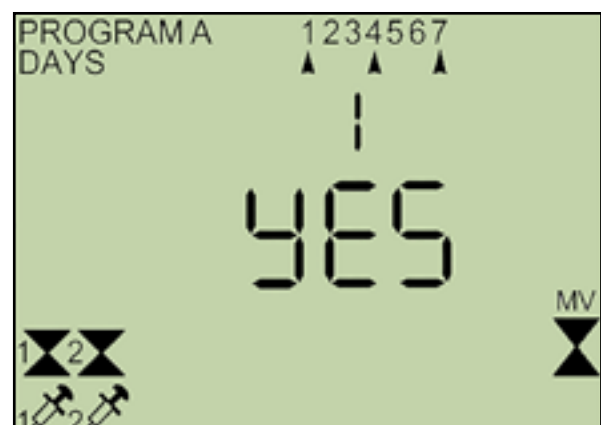

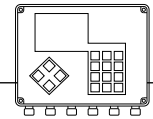

In both cases the displayed day changes to 2 and we repeat the procedure as on day 1.

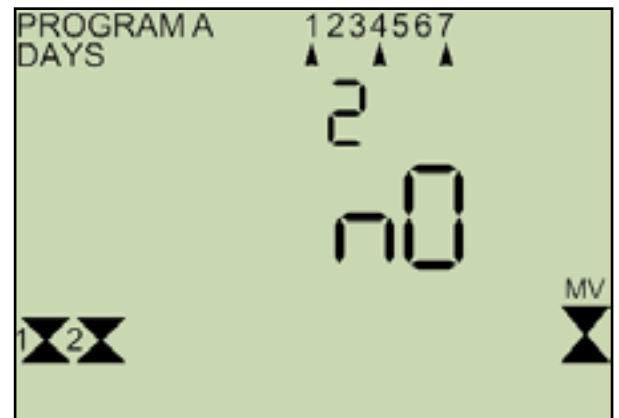

The rules are very simple:

- Each time you want to change to **Yes** you press the **+** key.
- Each time you want to change to **No** you press the **-** key.
- Each time you want to confirm the setting of the actual day and move to the next, press the **→** key.

Setting Irrigation Days by use of Cycle of Days

While the word **DAYS** is blinking, press the **→** key to enter and set the planned cycle of days or the cycle of days left.

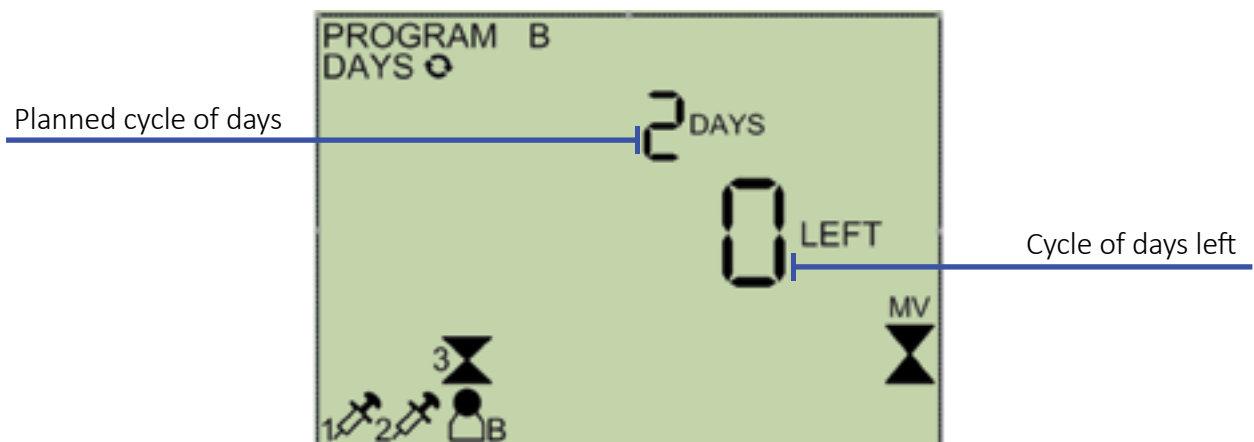

While the planned cycle of days is blinking use the **+** key to increase or the **-** key to decrease the value and confirm by pressing the **→** key.

While the cycle of days left is blinking use the **+** key to increase or the **-** key to decrease the value and confirm by pressing the **→** key.

How does the count of the cycle of days work? Only when the program is started by a start time (not manually), the planned cycle of days is automatically copied to the left cycle of days. Every day at midnight the left days are deducted until becoming 0, indicating that the current day is an active irrigation day, in which the defined start times become effective.

NOTE: The user can manually overwrite the cycle of days left at any time and thus delay or advance the next active irrigation day.

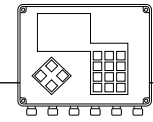

Defining Start Times of Programs

Each program can have up to 6 start times. There is no priority between the start times, and the only order that matters is the chronological order.

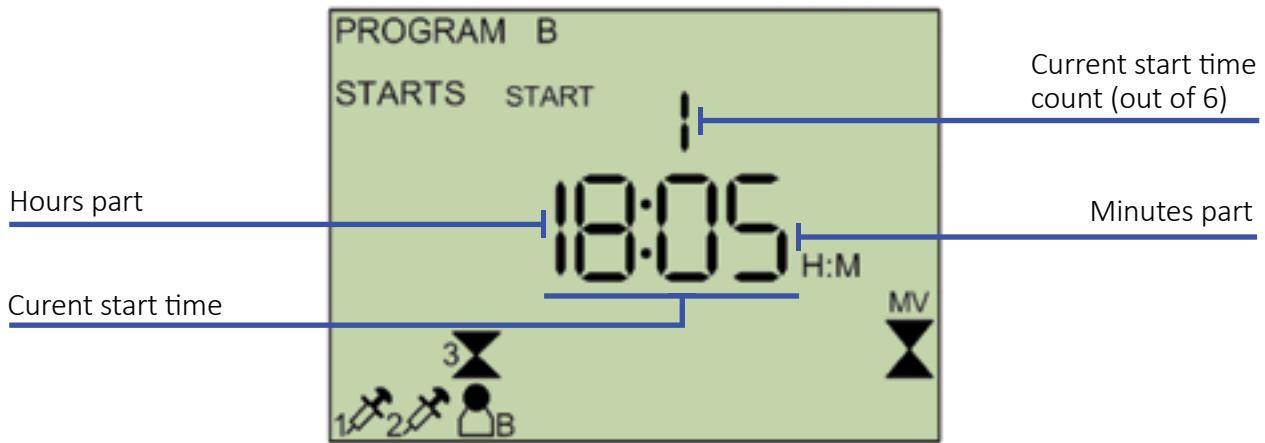

- **Step 1** - While the word **Starts** is blinking, press the key to set the start times. The procedure enables setting each of the six start times.
- **Step 2** - While the current start time count ("1" in the example above) is blinking, you can use the key to move forward to the next start time, or the key to move back to the previous start time. When arriving to the desired start time press the key to confirm.
- **Step 3** - The hours part of the current start time starts blinking, use the key to increase the value or use the key to decrease the value. Then press the key to move to the minutes part. Use the same keys to edit the minutes part.
- **Step 4** - Press the key again to get back to step 1.

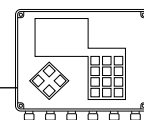

← Back

Defining the Water Valve Runtime

The water runtime of a valve indicates how long the irrigation valve remains open after being activated. In order to include a valve in the selected irrigation program, it must have its water runtime set to a nonzero value. The units used for measuring the water runtime are the units selected at the setup procedure for the particular program.

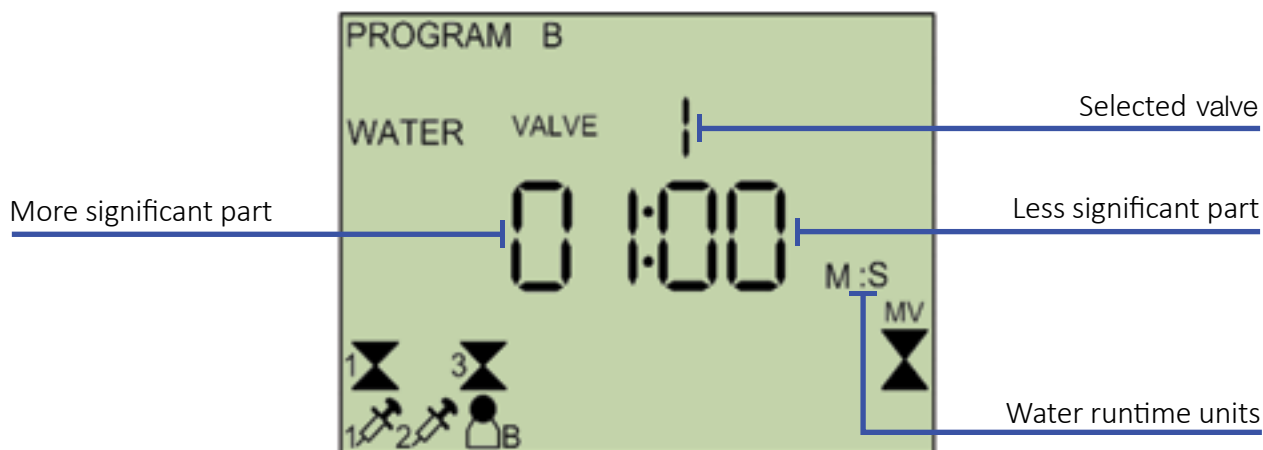

- **Step 1** - While the the word **Water** is blinking press the key. The valve number starts blinking.
- **Step 2** - To move to another valve use the or key until you get to the desired valve whose water runtime you want to set. Press the key again. The two digits of the more significant part of the water runtime of the selected valve start blinking.
- **Step 3** - Use the key to increase or use the key to decrease the value and confirm by pressing the key. The two digits of the less significant part of the water runtime start blinking.
- **Step 4** - Use the same keys of step 3 to edit the less significant part. When done, the word **Water** starts blinking again, as in step 1. If no more valves need to be set for the water runtime, use the or keys to move to another parameter. Otherwise, press the key and you are back at step 2.

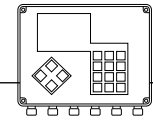

Defining the Fertilizer Valve Runtime

When the system contains two fertilizer injectors, each injector can have its own runtime setting for each valve in each of the programs. The fertilizer runtime indicates how long the fertilizer injection lasts after being activated. The units used for measuring the fertilizer runtime are the units selected for the particular program at the Setup procedure.

NOTE: A fertilizer runtime of valves that have no defined water runtime, will be ignored.

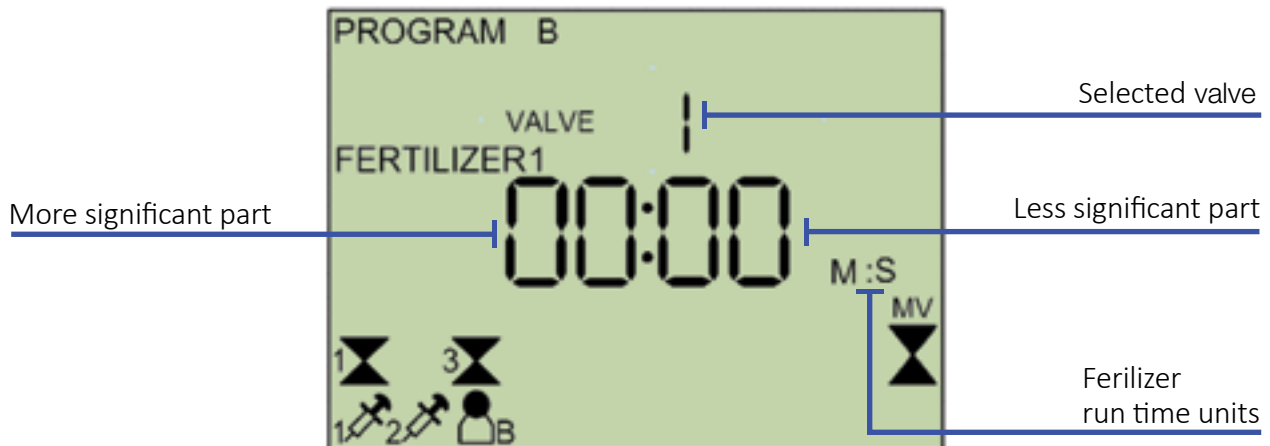

- **Step 1** - While the word **Fertilizer 1** is blinking, press the key. The valve number starts blinking.
- **Step 2** - If you wish to move to another valve, use the or keys until you get to the desired valve, whose fertilizer runtime you want to set and press the key again. The digits of the more significant part of the fertilizer runtime of the selected valve start blinking.
- **Step 3** - Use the key to increase or use the key to decrease the value and confirm by pressing the key. The digits of the less significant part of the fertilizer runtime start blinking.
- **Step 4** - Use the same keys of step 3 to edit the less significant part. When done, the word **Fertilizer 1** starts blinking again, as in step 1. If your system contains another fertilizer injector, pressing the key causes the word **Fertilizer 2** to start blinking; otherwise it will get you to the next parameter, in that case step 5 is skipped.
- **Step 5** - If you wish to set the fertilizer runtime of the second injector as well, use the key and repeat steps 2, 3 and 4 above.

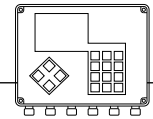

← Back

Adjusting the Water Runtime by %

The water runtime for all the valves included in a program can be adjusted by % upward (up to 250%) or downward (down to 0%) in steps of 5%. The adjustment does not affect the fertilizers runtime. The adjustment by % is also known as water budget. It is important to point out that the original water runtime remains unchanged.

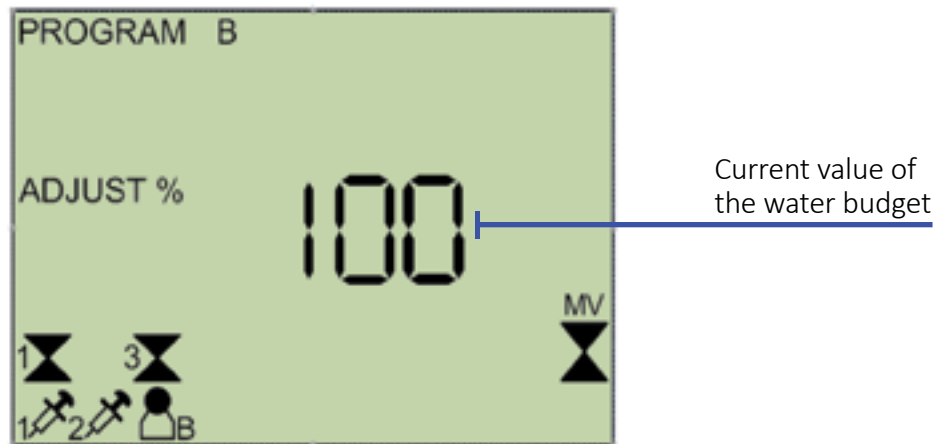

While the word **Adjust %** is blinking, press the **←** key to set the water budget.

The current value of the water budget starts blinking. Use the **+** key to increase the value or use the **-** key to decrease the value and press the **←** key to confirm.

Setting the Current Time and Current Day

The last screen you come to when moving through all the parameters of any irrigation program enables setting the current time and current day. In fact, it is important for the controller to know the current day and time in order to be able to start the irrigation programs on time.

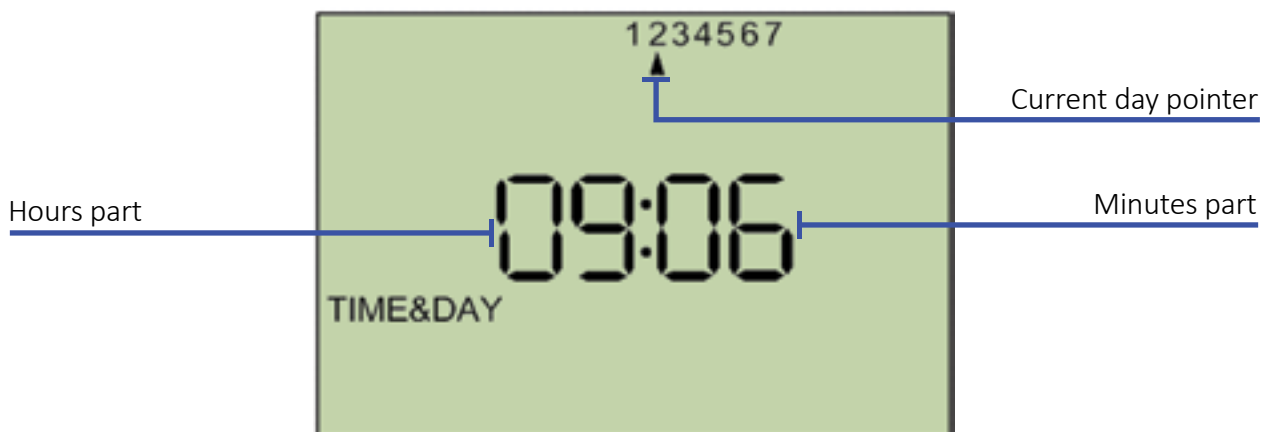

- **Step 1** - When the words **Time & Day** are blinking, press the **←** key and the hours part starts blinking.
- **Step 2** - Use the **+** key to increase the value or use the **-** key to decrease the value and press the **←** key to confirm. The minutes part starts blinking.
- **Step 3** - Use the same keys for setting the minutes part. When done, the arrow pointing to the current day starts blinking.
- **Step 4** - Use the **+** key to move the arrow to the next day or use the **-** key to move to the previous day and press the **←** key to confirm.

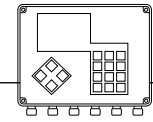



Manual Start/Stop of Programs

Any program can be started /stopped manually. When the desired program is selected, use the **(M)** key to manually change its status. If the program is idle, it starts running and if it is already running, it will stop. When a program was started manually, the  symbol is displayed on the screen for that program.



3. Monitoring Operation

How do we know what the controller is doing now? How do we know which programs are running and which valves are open? What is the stage an active program has reached?

In order to get the answers to these questions we need first to get to the [Opening](#) screen (as explained above) then we can move program by program and look at the indicators of the outputs belonging to each program. Blinking indicators indicate activated outputs.

When filters backflushing is in progress, the indicators of the filters  blink in any of the irrigation programs displays. If the flushing was triggered by the DP sensor, then the  indicator appears as well. Under normal conditions the  indicator should not be blinking. However, when it does blink, it indicates an endless looping of the backflushing program.

In order to see the [Left](#) Runtime of water and fertilizers of a running program, hold down the  key for 3 seconds, the following screen is displayed:

The word [Left](#) blinks along with the irrigating valve and all the other active accessories. In the example to the right, the irrigating valve is valve 1 and it has a Left water runtime of 20 minutes and 43 seconds. Now you can use the  and  keys to scroll between the [Left](#) runtimes of the water and the fertilizers. In order to exit the [Left](#) quantities setup press the  key.



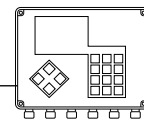

4. Filters Backflushing

Program F is the program for the filters backflushing. The program can be started manually at any time, but it can be triggered to start by DP or by elapsed time only when there is an irrigation program in progress. The controller also has counters that count how many times the flushing program was started by DP and how many times it was started by elapsed time.

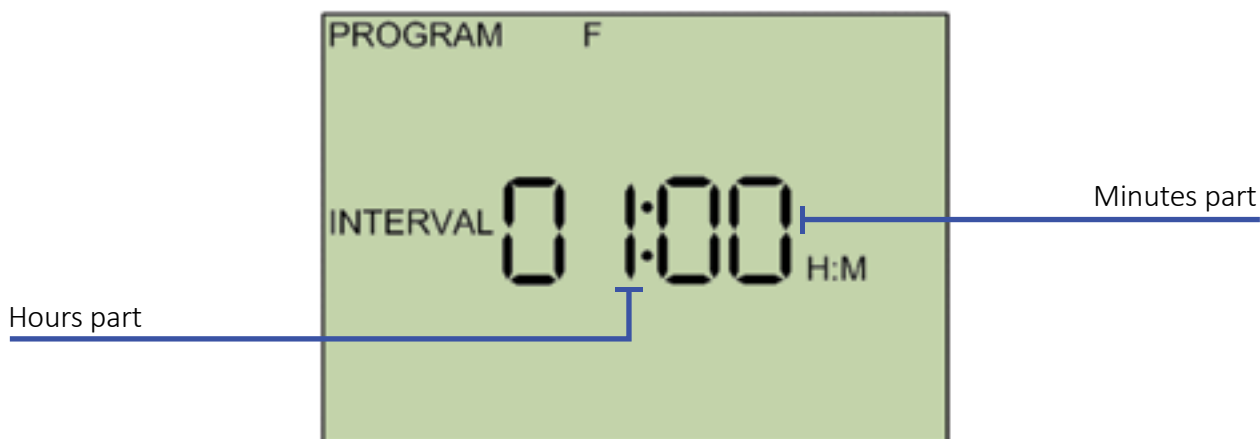

- **Step 1** - When program F is selected and the letter F does not blink, use the **+** key to move to the first screen of the backflush program, in which the Interval between flushing cycles is defined. The word **Interval** starts blinking.
- **Step 2** - Press the **←** key. The hours part of the interval starts blinking.
- **Step 3** - Use the **+** key to increase the value or use the **-** key to decrease the value and press the **→** key to confirm. The minutes part starts blinking.
- **Step 4** - Use the same keys for setting the minutes part. When done, the word **Left** appears and now, if you wish to delay or advance the next flushing cycle, you can repeat steps 3 and 4 to define the **Left** Interval.

When done, the word "Interval" blinks. Use the **+** key to get to the next screen to define dwell time. The word **Dwell** starts blinking. Dwell time defines the delay between the flushing stations.

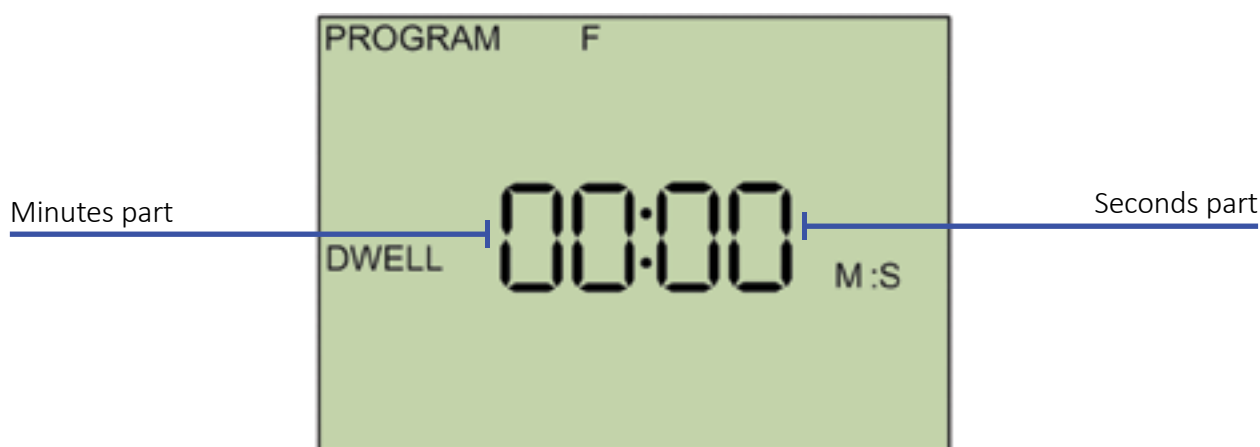

- **Step 5** - Set the minutes part and the seconds part of the dwell time as explained in steps 2, 3 and 4 above. When done, the word **Dwell** blinks. Use the **+** key to get to the next screen to define flush time.

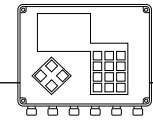

The word **Flush** starts blinking. Flush time defines the flushing duration for each station.



- **Step 6** - Set the minutes part and the seconds part of the flush time, as explained in steps 2, 3 and 4 above. When done, the word flush blinks again. At this stage, defining the backflush program F is completed.

NOTE: Once the flush time is set, it can be edited, but cannot be cleared completely. Once the flush time is set, the filter indicators  are displayed on the bottom of the screen.

- **Step 7** - The remaining two screens of the program show flushing cycle counters, one triggered by time and one triggered by DP. Use the  key to move from one screen to the other.

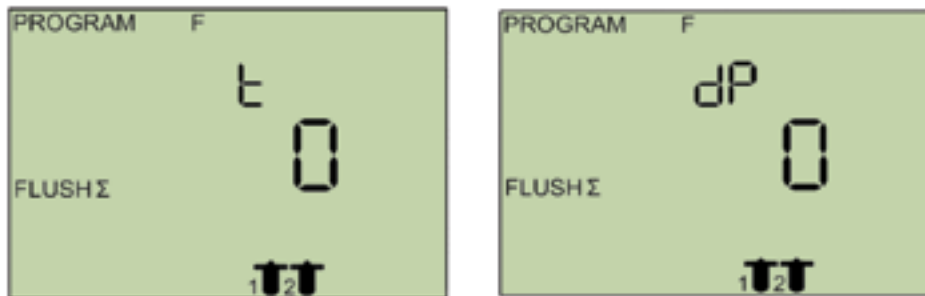

When the **t** or **dP** is blinking you may press the  key to edit the counter. Usually, it will be used for resetting the value to 0.

5. Rain Delay

When the input of the rain sensor senses a closed contact, the umbrella indicator  is displayed and the operation of the irrigation programs are influenced in the following way:

All the programs that are already running stop and as long as the rain indication exists all start times are ignored and even manually starting a program is disabled.

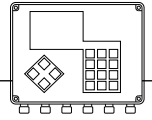

6. The Special Function of Program "C" Irrigation

Program C has the same functions as programs A and B, but, additionally, it can be started by a sensor.

When the input marked by , senses a closed contact, program C starts irrigating. If the contact is still closed when the program terminates, it causes the program to start again. This feature enables using program C for frost protection, or for filling a reservoir by a level sensor.



It is important to point out that as long as the rain sensor indicator is displayed , the  sensor is not effective.



7. Initial Setup Procedure

Before using the controller for controlling irrigation, fertigation and backflushing, the following things must be defined in the setup procedure:

- **The type of clock to be used:** 24 hours or AM/PM clock.
- The outputs allocation.
- **For each of the programs (A, B, C):**
 - » Whether to use Days Cycle or Run List for specifying irrigation days.
 - » Whether to use hours:minutes or minutes:seconds for dosing the water and fertilizers.

How to Enter into the Setup Procedure

The setup procedure can be entered by simultaneously pressing the  and  keys and holding them down. To exit the setup procedure press and hold down the  key.

Once inside the setup procedure, use the  and  key to move from one programmable object to another.

Example : As an example, we shall demonstrate moving through the screens of the setup procedure:

- Press and hold down the  and  keys. The first screen of the setup is displayed:

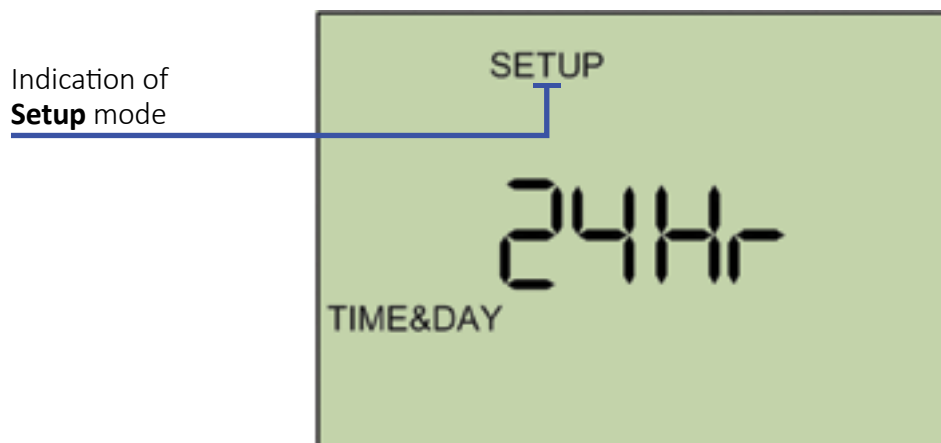

The words **Time & Day** blink to indicate the current parameter. To enter and change from 24 hours clock to AM/PM clock press the  key.

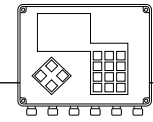

← Back

Press the **+** key to move to outputs allocation.

The word **Outputs** blinks, indicating the current parameter. To enter and change the existing outputs allocation, press the **→** key and define all the outputs that are to be controlled by the controller.

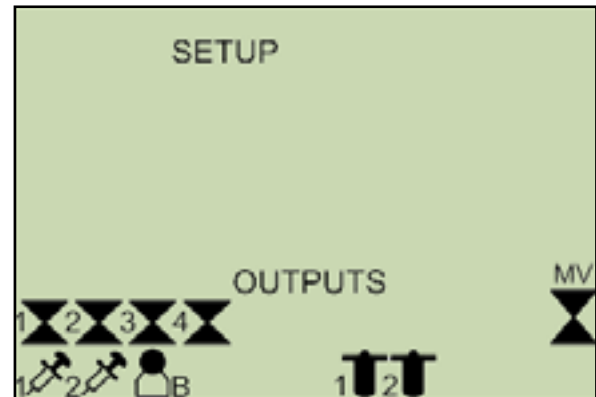

Press the **+** key to move to the next parameter that enables defining the irrigation days and the units used for defining the runtimes. These settings are done for each program.

The word **Units** blinks to indicate that this is the current parameter. To enter and change the mode of defining the irrigation days or the runtime units press the **→** key.

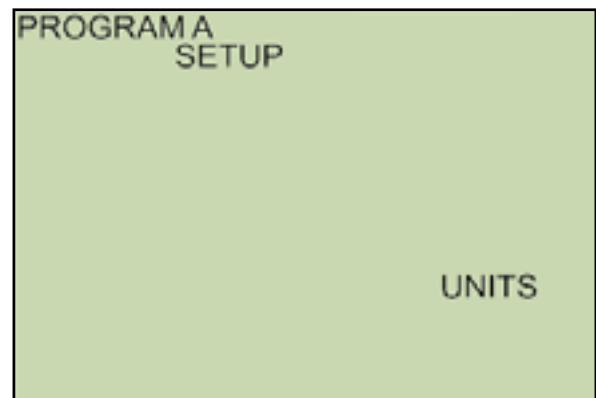

Press the **+** key to move to the next screen in which the software version of the controller is displayed.

This is the last screen in the setup procedure. Nothing can be changed from this screen, it only displays information.

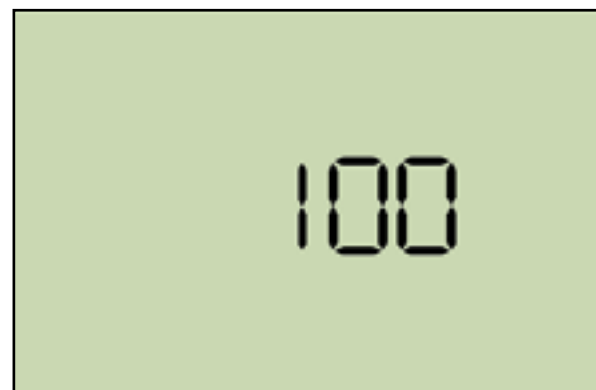

Press and hold down the **→** key to exit the setup procedure.

The next section explains in details how each step of the setup procedure is performed.

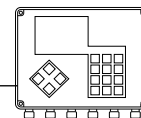

← Back

Selecting between 24 hours clock and AM/PM clock

Enter the setup mode by simultaneously pressing the **+** and **-** keys and holding them down. The **Time Mode** screen is displayed.

The words **Time&Day** blink to indicate that this is the current parameter. Press the **-** key and the **24Hr** display blinks.

To change the 24 hour clock to AM/PM, press the **+** key.

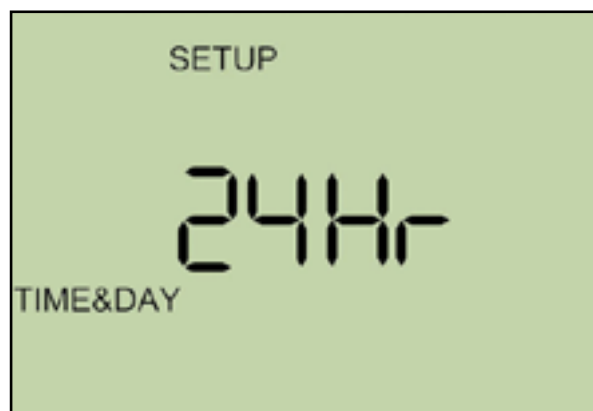

The following screen is displayed.

The **AM/PM** display blinks. To confirm the selection, press the **+** key.

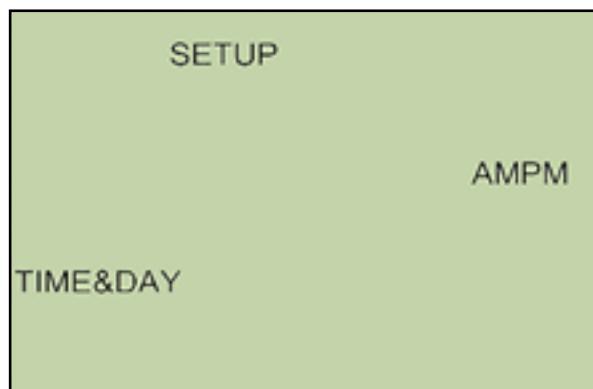

Defining the Outputs in Use

The modular structure of the controller enables it to have 2, 4, 6, 8, or 10 outputs. The number of outputs available depends on the number of plug-in boards in use. Each plug-in board contributes 2 outputs.

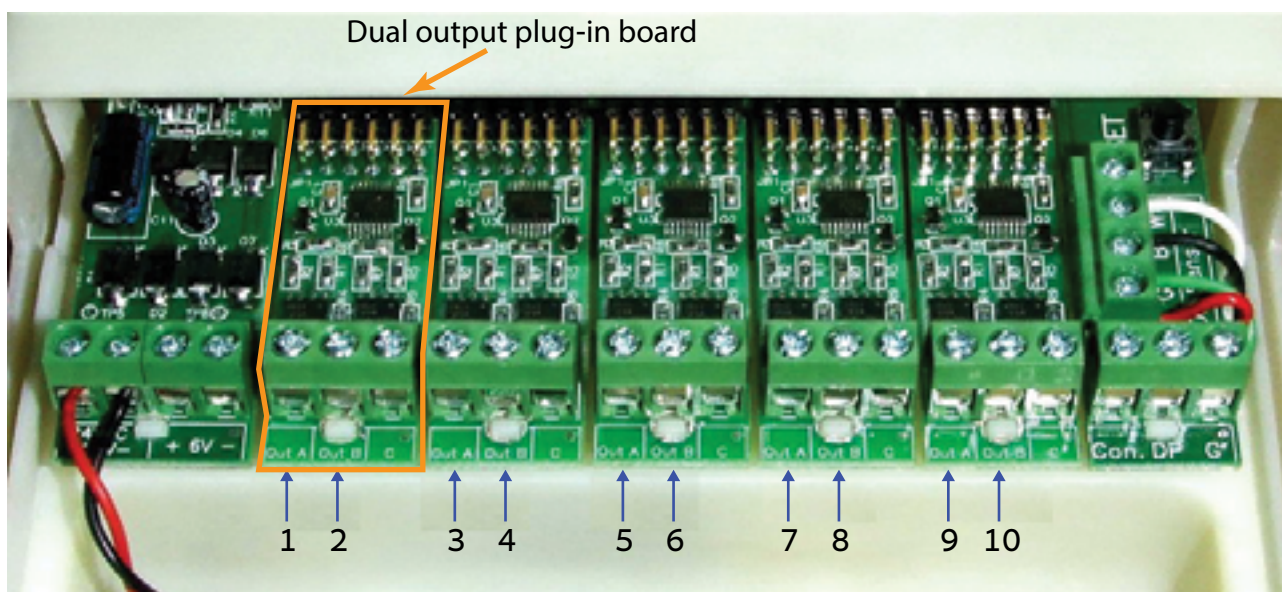

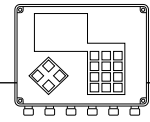

← Back

The available outputs can be allocated for Irrigation valves, a main valve, fertilizer injectors, booster, and backflush valves. The order of connection of the allocated outputs is explained in a separate section below.

The allocation procedure is as follows:

Enter setup mode as explained above and press the **+** key until the **Outputs Allocation** screen is displayed.

The word **Outputs** blinks to indicate that this is now the current parameter for editing.

Press the **←** key.

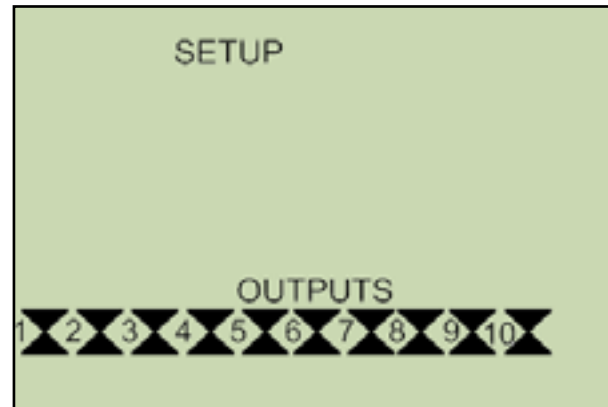

A blinking number appears on the screen:

The blinking number **10** (in other cases it may be a different number) indicates that all **10** outputs are currently allocated for irrigation valves. The irrigation valves indicators  also blink.

If the system to be controlled contains only 4 irrigation valves, press the **-** key 6 times to reduce the number of valves to 4 and press the **←** key to confirm.

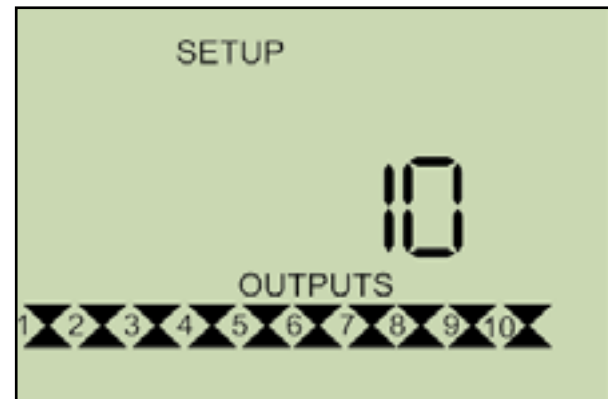

The following screen enables allocation of a main valve when the system includes a main valve.

The main valve indicator  and the word **No** blink. If the system includes a main valve, press the **+** key to change the **No** to **Yes**. If the system does not include a main valve leave the **No** as it is. Press the **←** key to confirm.

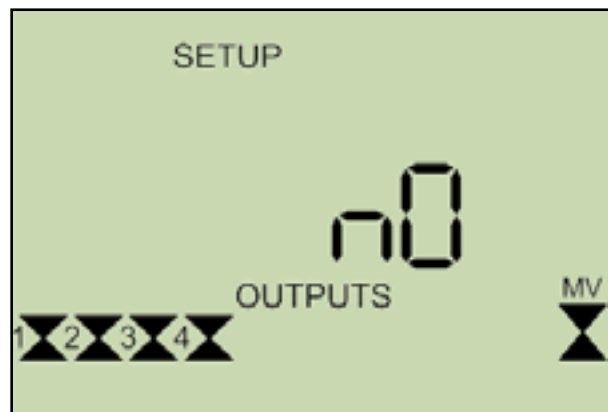

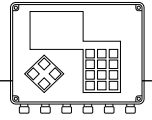



← Back

The next screen enables allocation of fertilizer injectors.

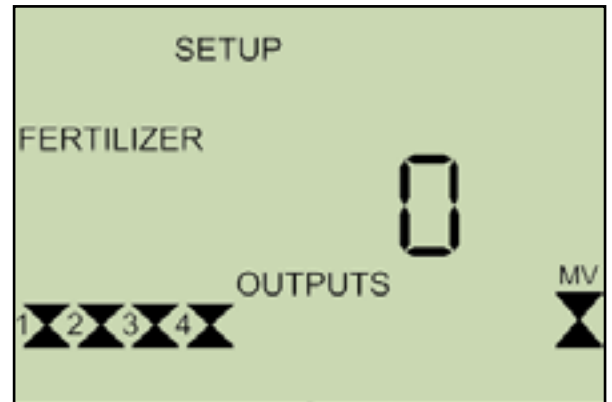
Yes, as you probably guessed, the blinking 0 indicates that currently there are no fertilizer injectors defined. If you wish to include 1 or 2 fertilizer injectors in the configuration, press the + key once or twice and press the - key to confirm.



The next screen enables allocation of a booster pump in case it is needed.

The booster indicator  and the word No blink to indicate that currently there is no booster defined. If you wish to allocate a booster pump press the + key. If you do not wish to allocate a booster pump, leave it as is. Press the - key to confirm.

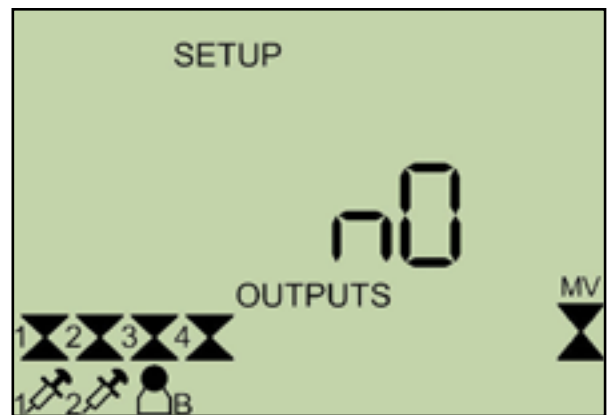

The next screen enables allocation of the filters backflush valves.

The blinking 0 indicates that currently there are no backflush valves allocated. Each push of the + key allocates an additional backflush valve. When finished adding backflush valves, press the - key to confirm.

NOTE: The maximum number of backflush valves is 4.

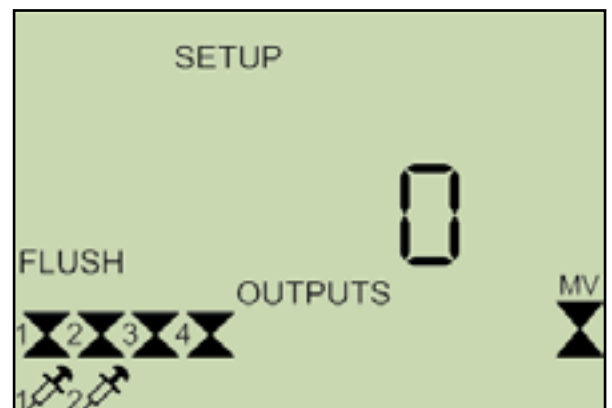

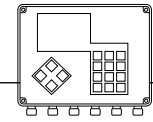

← Back

The last setup screen shows all the allocations defined in our example, which include: 4 irrigation valves, 1 main valve, 2 fertilizer injectors, and 2 backflush valves.

The word **Outputs** blinks like it did in the first screen of the allocations procedure.

Press the **←** key to enter the allocation procedure again from the beginning.

Press the **+** key to advance to the next parameter of the setup procedure that enables defining the modes of the irrigation days and the dosing units to be used by the irrigation programs.

NOTE: It is important to understand that in all the cases above in which we used the **+** key to increase values or move forward, we could have used the **−** key to decrease values or move backward. Also when we used the **+** key to turn a **No** into **Yes** the **−** key would have done the opposite.

NOTE: Once all available outputs are allocated, (regardless of the stage we are in the outputs setup) the controller will skip to the first screen where the word **Outputs** is blinking.

For an example of the connections see "Connection of Outputs and Inputs to the Terminal Board" on page 23.

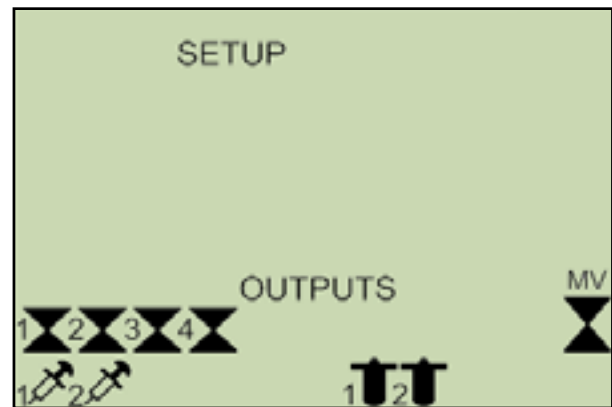

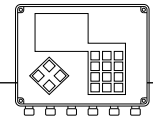

8. Defining the Dosing Units and the Mode of Setting the Irrigation Days

The decision about which units are used for the water and fertilizers runtime definition and how the irrigation days are defined, is made during the setup procedure for each irrigation program

A, B and C are defined independently as to whether the irrigation days are defined by a run-list or as a cycle of days and as to whether the runtime will be expressed in hours:minutes or minutes:seconds .

Enter setup mode as explained above and press the **+** key until the following screen is displayed:

While the word **Units** is blinking press the **←** key.

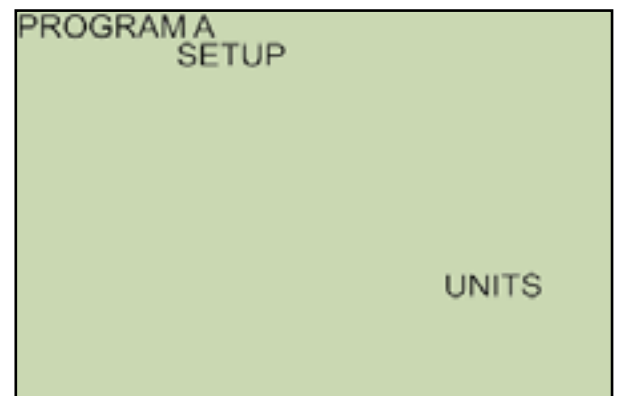

The following screen is displayed:

While the letter **A** is blinking, advance to the relevant program using the **+** and **-** keys to move forward or backward.

Press the **←** key to select the program.

There are two modes of setting the irrigation days. The first mode uses the **cycle of days** and the second mode uses a **run-list**.

When using the **cycle of days** mode, the user defines the interval between each irrigation: a value of 1 defines a daily irrigation, 2 defines irrigation for every second day, etc...

When using the **run-list** the user must mark each individual day of the week for which there is irrigation.

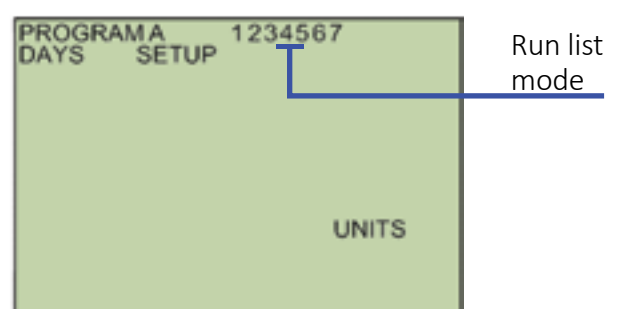
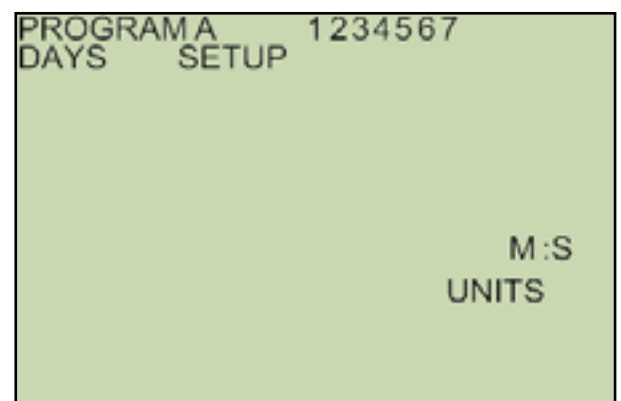

Use the **+** and **-** keys to select the desired mode and confirm by pressing the **←** key.

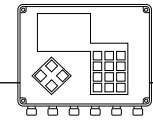



← Back

The following screen enables selection between hours:minutes or minutes:seconds to be used for setting the runtime of water and fertilizers.

Use the  and  keys to change the units and confirm your selection by pressing the  key.

NOTE: At any stage during the setup procedure, if the key board is left untouched for 1 minute the system will automatically exit setup mode and return to normal mode. Another way to force exit from setup mode is by pushing and holding down the  key.

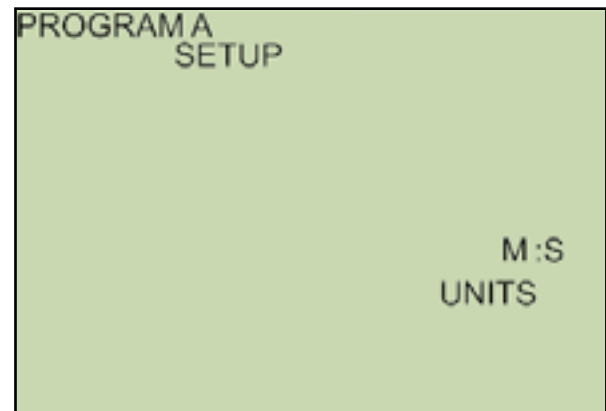

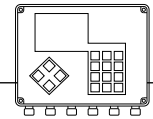

9. Connection of Outputs and Inputs to the Terminal Board



The defined accessories are connected to the terminal board according to the following rules:

- Irrigation valves are connected starting from output 1 and up.
- Backflush valves follow the last irrigation valve and continue upward.
- The main valve (when included) is connected to the highest available output.
- The booster (when included) are connected in front of the main valve or, if there is no main valve, the booster is connected to the highest output.
- Fertilizer injectors are connected in front of the booster, or if there is no booster, then in front of the main valve. If there is no main valve, they are connected to the highest available outputs.
- Injector 1 is connected at the lower output.

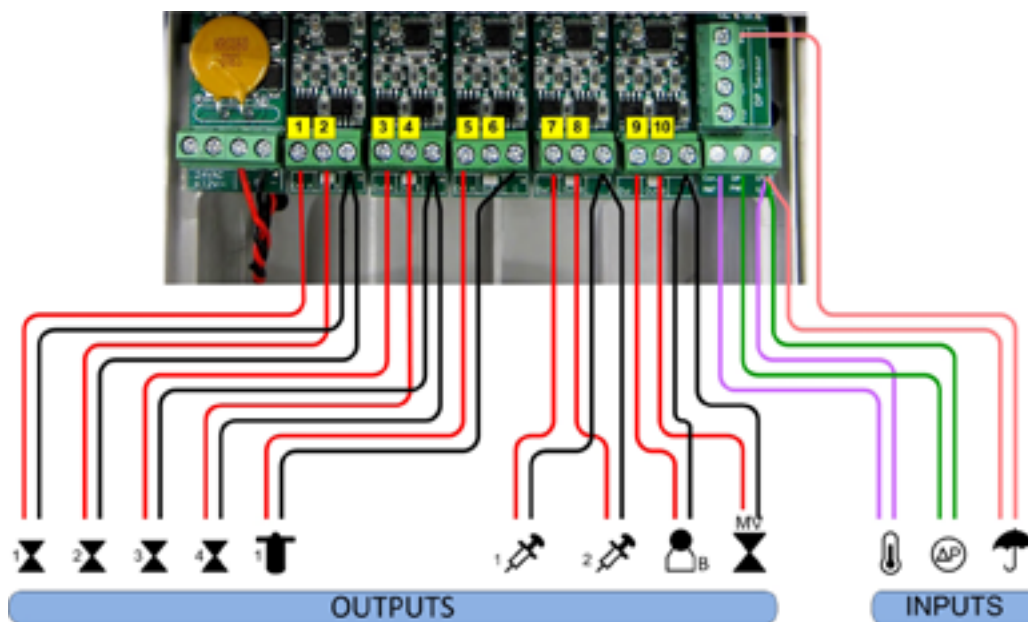
For example, a controller with 10 outputs that needs to handle 4 Irrigation valves , 1 Backflush valve , 2 Fertilizer injectors , a Booster , and a Main valve , will have the following order of outputs connection:



The 3 dry contact inputs recognized by the controller have fixed connection points. The drawing shows where each of the sensors is connected:

-  the sensor for triggering the start of program C.
-  the DP sensor for triggering the backflushing by program F
-  the rain sensor that triggers the rain delay

NOTE: Sensor type / connection should be “normally open”.

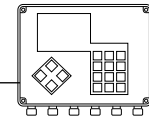

10. Alarm Conditions Detected by the Controller

Low Battery Detection



When the controller is powered by batteries, the system detects low battery status by measuring the time it takes to restore the outputs capacitor to the required level. If it takes less than 6 seconds the battery is considered in acceptable condition. If it takes more than 6 seconds, the battery is considered low and it will be indicated by the blinking battery indicator  and by a specific sound. All activities continue as usual until restoring the capacitor takes more than 10 seconds. Then the battery is considered being in critical condition. All outputs shut down, including the specific sound, all activities stop and only the indicator of the low battery remains.

No AC Power

When the controller is powered from the facility power supply and there is a power outage, the no power indicator  is displayed on the screen. The controller continues to run with the power coming from its backup battery and, although the programs seem to continue running and counting down the runtimes, physically all outputs are shut down.

Short Circuit

The AC model of the controller detects short circuited outputs. Notification of a short circuit is given in the following way:

Under normal circumstances, when the keyboard is left untouched the display is goes blank. When a short circuit occurs, the screen displays a blinking lightning bolt indicator  and the number of the output at which the short circuit was detected. If a key is pressed and the display shows the [Opening](#) screen, the lightning bolt indicator  is displayed but it will be blinking only when the output with the short circuit is shown as well.

Endless Looping of the Backflush Program

When the DP contact repeatedly triggers flushing program F, after 5 repetitions, it will be considered an endless looping problem. As a result the controller ignores the DP sensor signal and the  indicator blinks on all screens of all programs to indicate that there is a problem.

NOTE: Remove the signal of the DP sensor to end the problem.

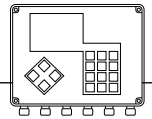

← Back

11. Wiring Diagram

DC MODEL

The drawing below shows the wiring of the DC model of the controller.

Notice that:

- The powering of the unit can be either 6v DC or 12v DC.
- The solenoids are 12VDC latch.

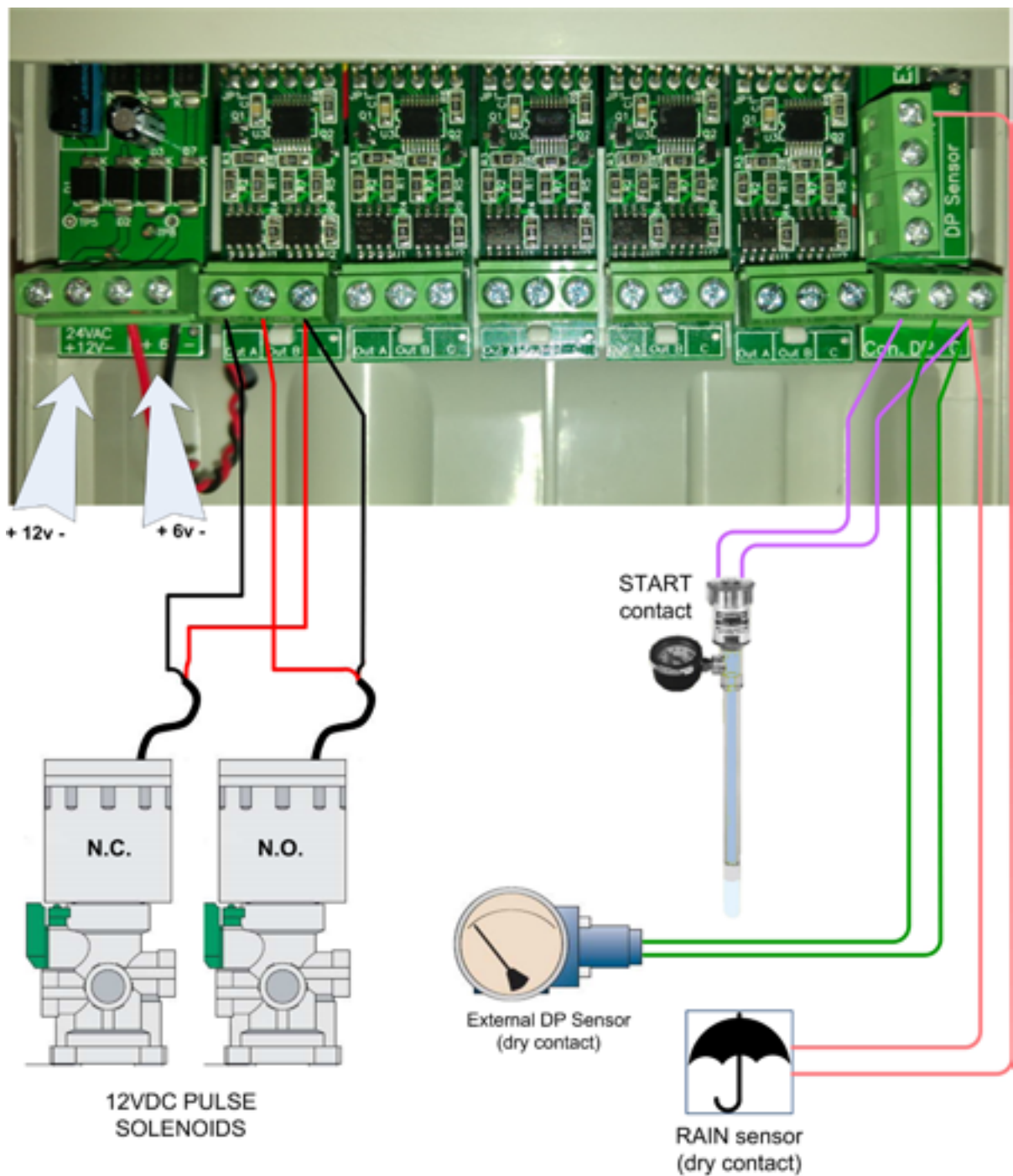

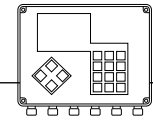

← Back

AC MODEL

The drawing below shows the wiring of the AC model of the controller.

Notice that: The powering of the unit is 24VAC transformed from 220/110 VAC.

- The solenoids are 24VAC.

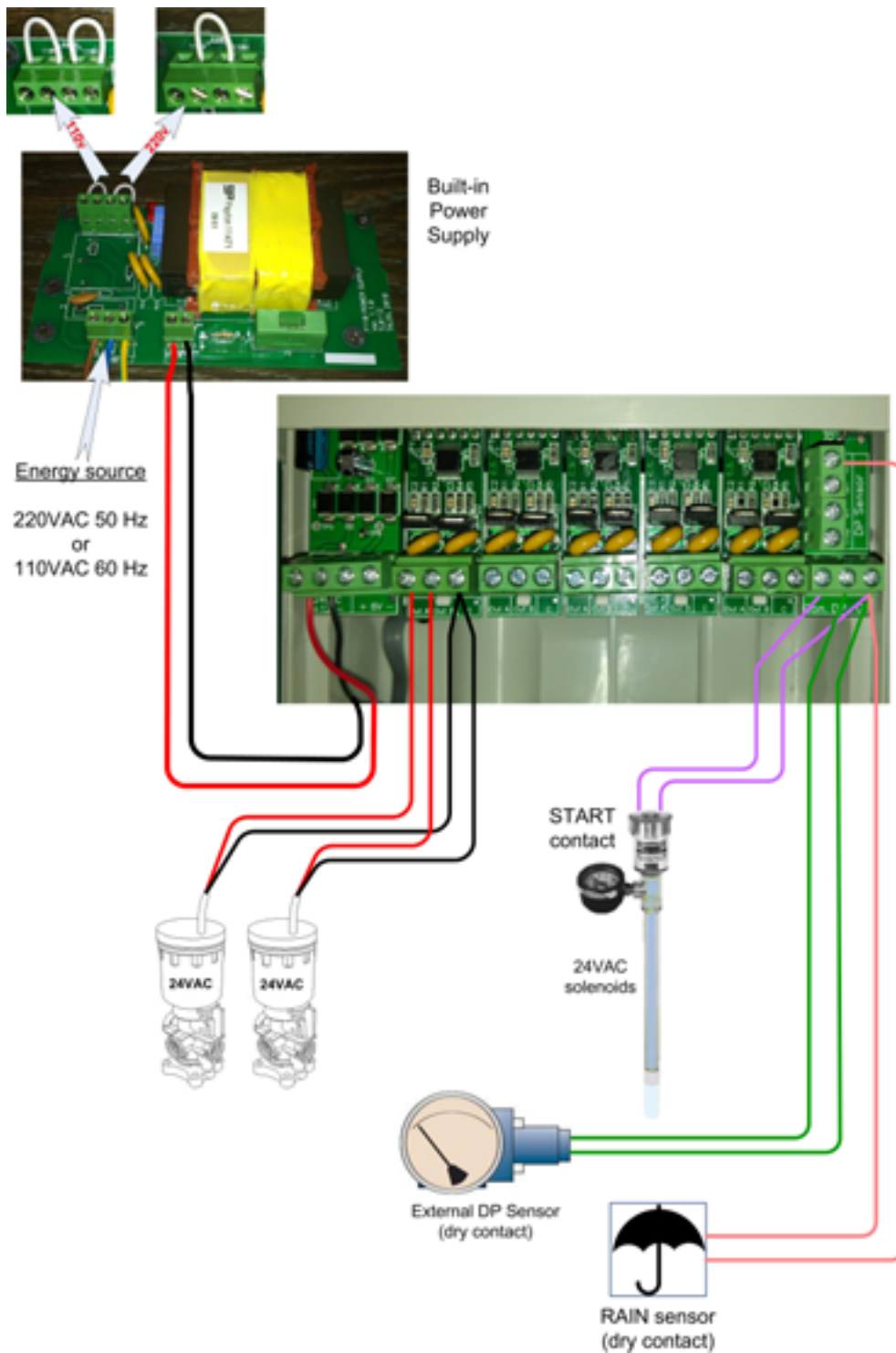

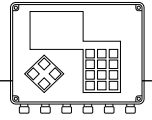

12. TECHNICAL DATA

DC MODEL

- Power source: 6v supplied by 4 x 1.5 "D" size alkaline batteries.
or 12v DC dry battery
or 12v rechargeable battery with solar panel of 2 watts
- Outputs : 12v DC latching solenoids.
- Digital inputs: Dry contact indication.
- Operating temperature: 0-60° C.

AC MODEL

- Power source: 220 or 110 v AC 50 or 60 Hz with built in transformer to 24v AC.
- Outputs : 24v AC solenoids.
- Digital inputs: Dry contact indication.
- Operating temperature: 0-60° C.

BERMAD Water Control Solutions



info@bermad.com • www.bermad.com

© Copyright 2007-2012 Bermad CS Ltd. All Rights Reserved. The information contained in this document is subject to change without notice. BERMAD shall not be liable for any errors contained herein.

Rev.1 Sep. 2015