

700

# LARGE SIZE SERIES

ENGINEERING DATA

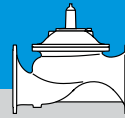

# CONTENT

<b>BERMAD 700 Large Size Series</b>	<b>2</b>
Model: 700-M5, 700-M6, 700-M5L	2
Features and Options	2
Technical Data	3
Valve Plugs Characteristics	3
Valve Travel	3
Flow Factors	3
Differential Pressure & Flow Calculation	3
<b>Flow Properties SI Metric</b>	<b>4</b>
Flow Properties US English	4
Dimensions Tables SI Metric	5
Dimensions Tables US English	5
Material Specifications 700-M5 / 700-M5L	6
Material Specifications 700-M6	7
Independent Check Feature	8
Principle of Operation	8

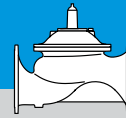

# BERMAD 700 LARGE SIZE SERIES

Model: 700-M5, 700-M6, 700-M5L

- Large scale pumping systems
- National and municipal water networks
- Reservoir and dam water level control
- Industrial water systems

The BERMAD 700 Series large size control valves are hydraulically operated, diaphragm actuated type. Unique hydro-dynamic globe valve design with a special open plug provides high flow capabilities. The valves are available in the standard configuration or with an Independent Flow Check code "2S". These valves are designed for large flow applications (On-off valve, pressure reducing, pressure sustaining, pump control, level control, check valve, flow control, burst control, emergency shut-off valve etc.), where precise control is needed.



## Features and Options

- Hydrodynamic wide globe valve body provides:
  - Higher flow (Kv; Cv) than standard globe valves
  - Higher resistance to cavitation damage
- In-line serviceable
- Valves are suitable for working with all types of command: Hydraulic, Electric and Pneumatic.
- Self-operated valves that can work without an external source of power.
- Wide range of options and accessories:
  - One-way or two-way flow direction
  - V-Port (optional)
  - Cavitation cage (optional)
  - Visual position indicator
  - Limit switches
  - Analog opening output
  - Large selection of control accessories
  - Double chamber actuation (700-M6)
  - Large inspection and service ports (700-M5L)

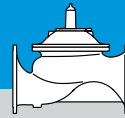

### Technical Data

**Valve Pattern:** Globe

**Size Range:** DN 500-1200; 20"-48"

**Pressure Rating:** PN10, 16 & 25

ANSI Class #150;

ANSI Class #300 (Consult Factory)

**End Connections:** Flanged

**Temperature:** Water up to 80°C; 180°F

**Coating:** Fusion Bonded Epoxy, RAL 5005 (Blue) certified

for drinking water applications, outside UV protection

### Valve Plugs Characteristics

**Kv; Cv to Valve Travel Graph**

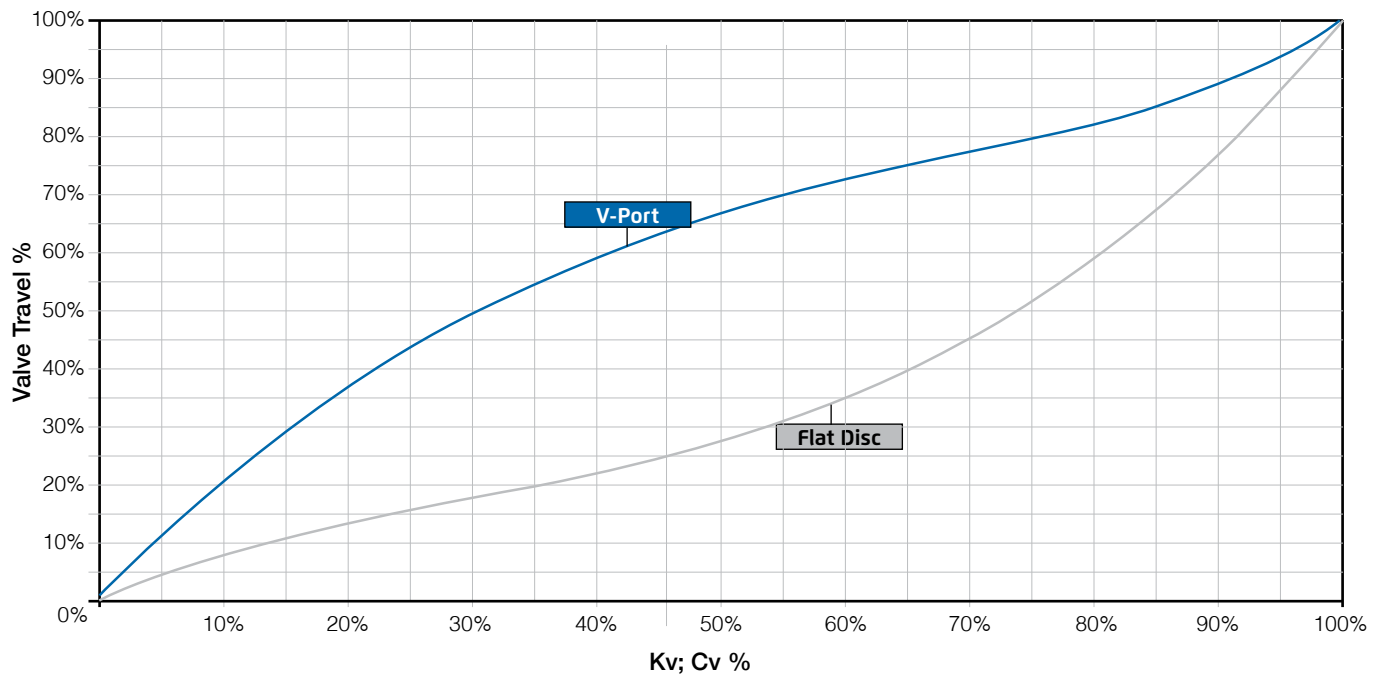

### SI Valve Travel

Type	M5	M6	M5L
mm	167	200	250

### US Valve Travel

Type	M5	M6	M5L
Inch	6 <sup>9</sup> / <sub>16</sub>	7 <sup>7</sup> / <sub>8</sub>	9 <sup>13</sup> / <sub>16</sub>

### SI Flow Factors

Type	M5	M6	M5L
Kv – Flat Disc	5,020	7,150	11,150
Kv – V-Port / Cage	Consult Factory		

### US Flow Factors

Type	M5	M6	M5L
Cv – Flat Disc	5,798	8,258	12,878
Cv – V-Port / Cage	Consult Factory		

### Differential Pressure & Flow Calculation

Valve flow coefficient,  $K_v = Q \sqrt{\frac{G_f}{\Delta P}}$

Where:

$K_v$  = Valve flow coefficient (flow in m<sup>3</sup>/h at 1bar ΔP)

$Q$  = Flow rate (m<sup>3</sup>/h)

$\Delta P$  = Differential pressure (bar)

$G_f$  = Liquid specific gravity (Water = 1.0)

Practical formulas for water:

$$Q = K_v \sqrt{\Delta P} \quad \Delta P = \left(\frac{Q}{K_v}\right)^2$$

Valve flow coefficient,  $C_v = Q \sqrt{\frac{G_f}{\Delta P}}$

Where:

$C_v$  = Valve flow coefficient (flow in gpm at 1psi ΔP)

$Q$  = Flow rate (gpm)

$\Delta P$  = Differential pressure (psi)

$G_f$  = Liquid specific gravity (Water = 1.0)

Practical formulas for water:

$$Q = C_v \sqrt{\Delta P} \quad \Delta P = \left(\frac{Q}{C_v}\right)^2$$

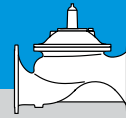

### Flow Properties SI Metric

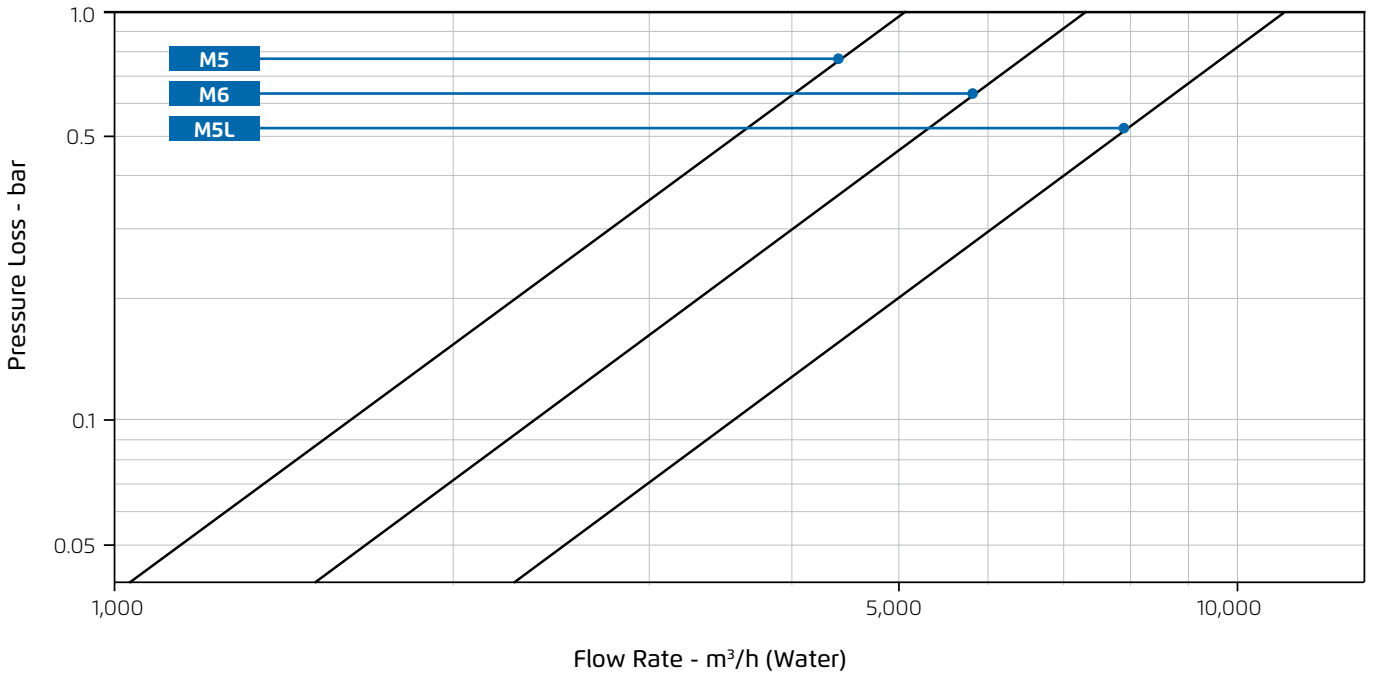

### Flow Properties US English

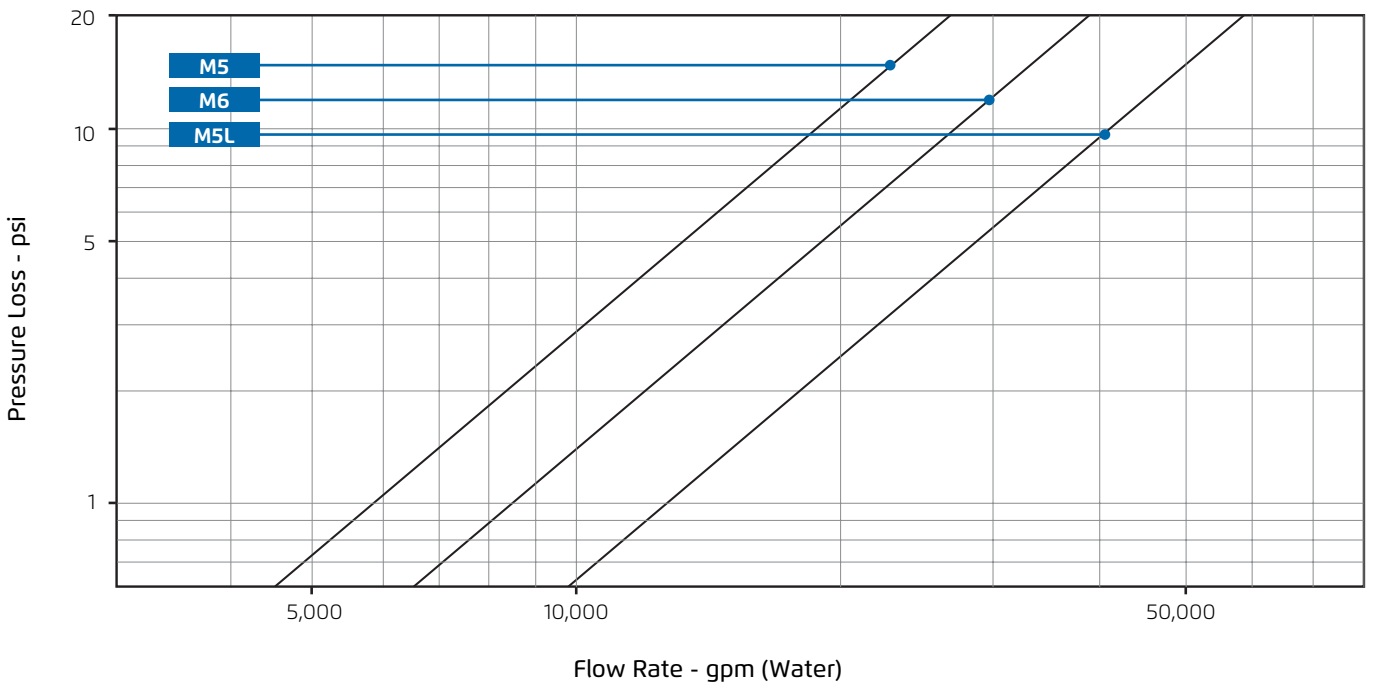

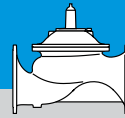

## Dimensions Tables SI Metric

Type	Inch	20"	24"	28"	30"	32"	36"	40"	42"	48"
	DN	500	600	700	750	800	900	1000	1050	1200
M5	L (mm)	1,250	1,450	1,650	1,750	1,850 1,865 <sup>(1)</sup>	-	-	-	-
	W (mm)	965	965	965	1,020	1,026 1,106 <sup>(1)</sup>	-	-	-	-
	h (mm)	385	435	500	530	530	-	-	-	-
	H (mm)	1,235	1,350	1,350	1,380	1,448	-	-	-	-
	Weight (kg)	1,318	1,590	1,745	1,711	1,920	-	-	-	-
M6	L (mm)	-	1,450 1,500 <sup>(1)</sup>	1,650	1,850	1,850	1,850	-	-	-
	W (mm)	-	1,250	1,250	1,250	1,250	1,250	-	-	-
	h (mm)	-	470	490	520	552	600	-	-	-
	H (mm)	-	1,965	1,985	2,015	1,760	1,810	-	-	-
	Weight (kg)	-	3,250	3,700	3,900	4,100	4,250	-	-	-
M5L	L (mm)	-	-	-	1,750	1,850	2,050	2,250	2,250	2,250
	W (mm)	-	-	-	1,425	1,425	1,425	1,425	1,345	1,530
	h (mm)	-	-	-	507	545	600	660	693	785
	H (mm)	-	-	-	1,740	1,780	1,835	1,900	1,913	2,001
	Weight (kg)	-	-	-	3,300	3,200	3,350	3,710	4,216	4,062

Notes: CF - Consult Factory | Length according to EN 558-1 | (1) = PN25

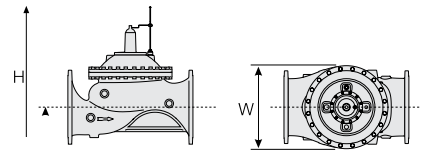

## Dimensions Tables US English

Type	Size	20"	24"	28"	30"	32"	36"	40"	42"	48"
M5	L (inch)	49 3/16	57 1/16	57 1/2	69	72 13/16 73 7/16 <sup>(2)</sup>	-	-	-	-
	W (inch)	38	38	38	40 3/16	40 3/8 43 9/16 <sup>(2)</sup>	-	-	-	-
	h (inch)	17 1/8	17 1/8	19 7/16	20 11/16	20 7/8	-	-	-	-
	H (inch)	48 5/8	53 1/8	55 1/2	54 5/16	57	-	-	-	-
	Weight (lb)	2,900	3,498	3,839	3,764	4,224	-	-	-	-
M6	L (inch)	-	57 1/16 59 1/16 <sup>(2)</sup>	64 15/16	68 7/8	72 13/16	72 13/16	-	-	-
	W (inch)	-	49 3/16	49 3/16	49 3/16	49 3/16	49 3/16	-	-	-
	h (inch)	-	18 1/2	19 5/16	20 1/2	22 13/16	23 5/8	-	-	-
	H (inch)	-	77 3/8	78 1/8	79 5/16	80 5/8	82 1/2	-	-	-
	Weight (lb)	-	7,150	8,140	8,580	9,020	9,350	-	-	-
M5L	L (inch)	-	-	-	68 7/8	72 13/16	80 11/16	88 9/16	88 9/16	88 9/16
	W (inch)	-	-	-	56 1/8	56 1/8	56 1/8	56 1/8	52 15/16	60 1/4
	h (inch)	-	-	-	19 15/16	21 7/16	23 5/8	26	27 5/16	30 7/8
	H (inch)	-	-	-	68 1/2	70 1/16	72 1/4	74 13/16	75 5/16	78 3/4
	Weight (lb)	-	-	-	7,260	7,040	7,370	8,162	9,275	8,936

Notes: CF - Consult Factory | (2) = Class #300 Consult Factory

## Control Chamber Displacement

Model	M5	M6	M5L
Liter	60	98	230

Model	M5	M6	M5L
US Gal.	15	26	61

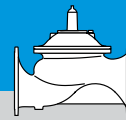

## Material Specifications 700-M5 / 700-M5L

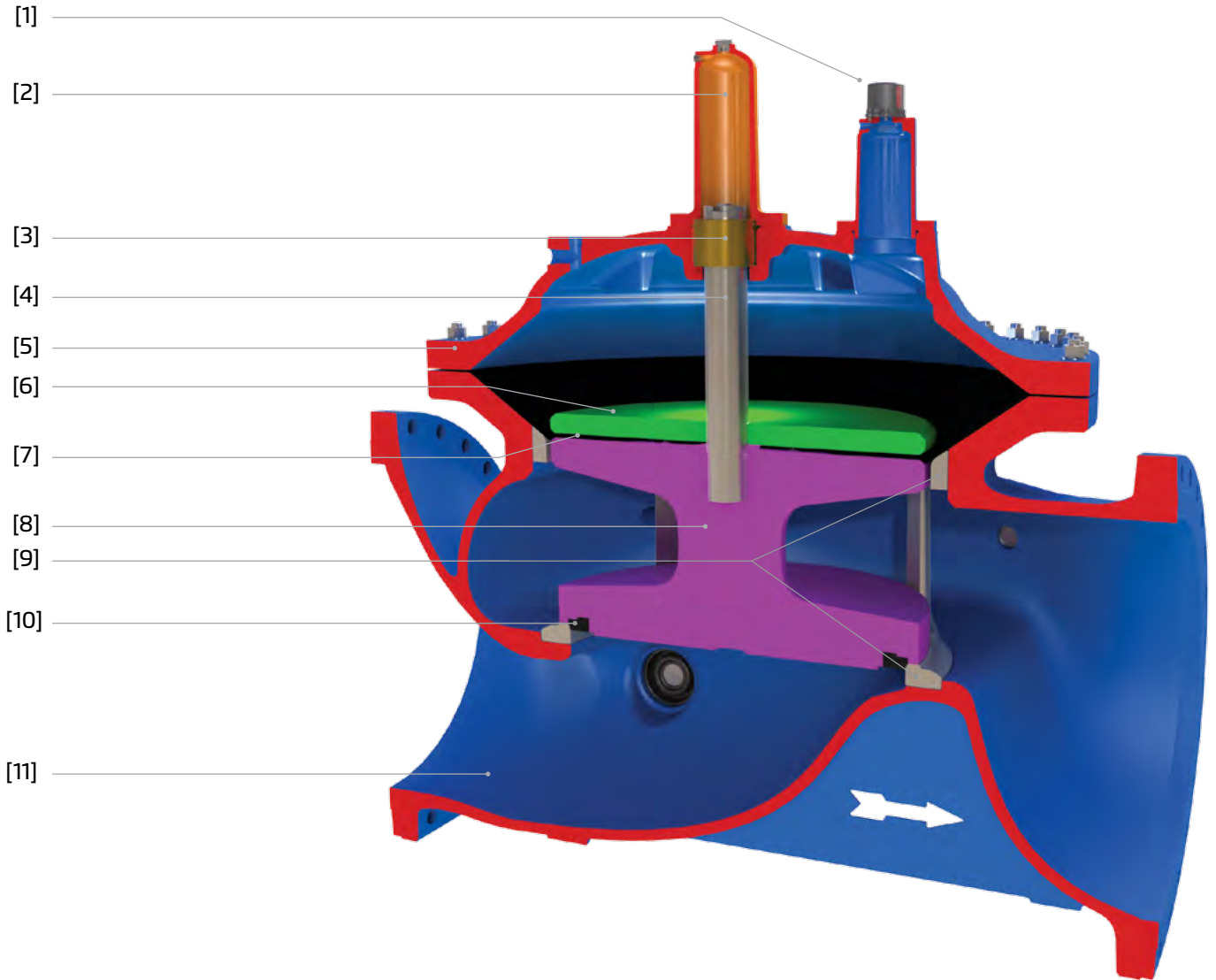

Item Number	Description	Material
1	Visual Opening Indicator (Quarter Turn or Linear)	
2	Top Guide Cover	Ductile Iron
3	Top Bearing	Tin Bronze
4	Top Guide	Stainless Steel
5	Valve Cover	Ductile Iron
6	Diaphragm Top Washer	Stainless Steel
7	Diaphragm	Synthetic Rubber Nylon Fabric Reinforced
8	Valve Plug	Ductile Iron
9	Valve Seat	Stainless Steel
10	Closure Seal	NR or Synthetic Rubber
11	Valve Body	Ductile Iron

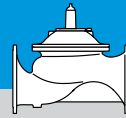

## Material Specifications 700-M6

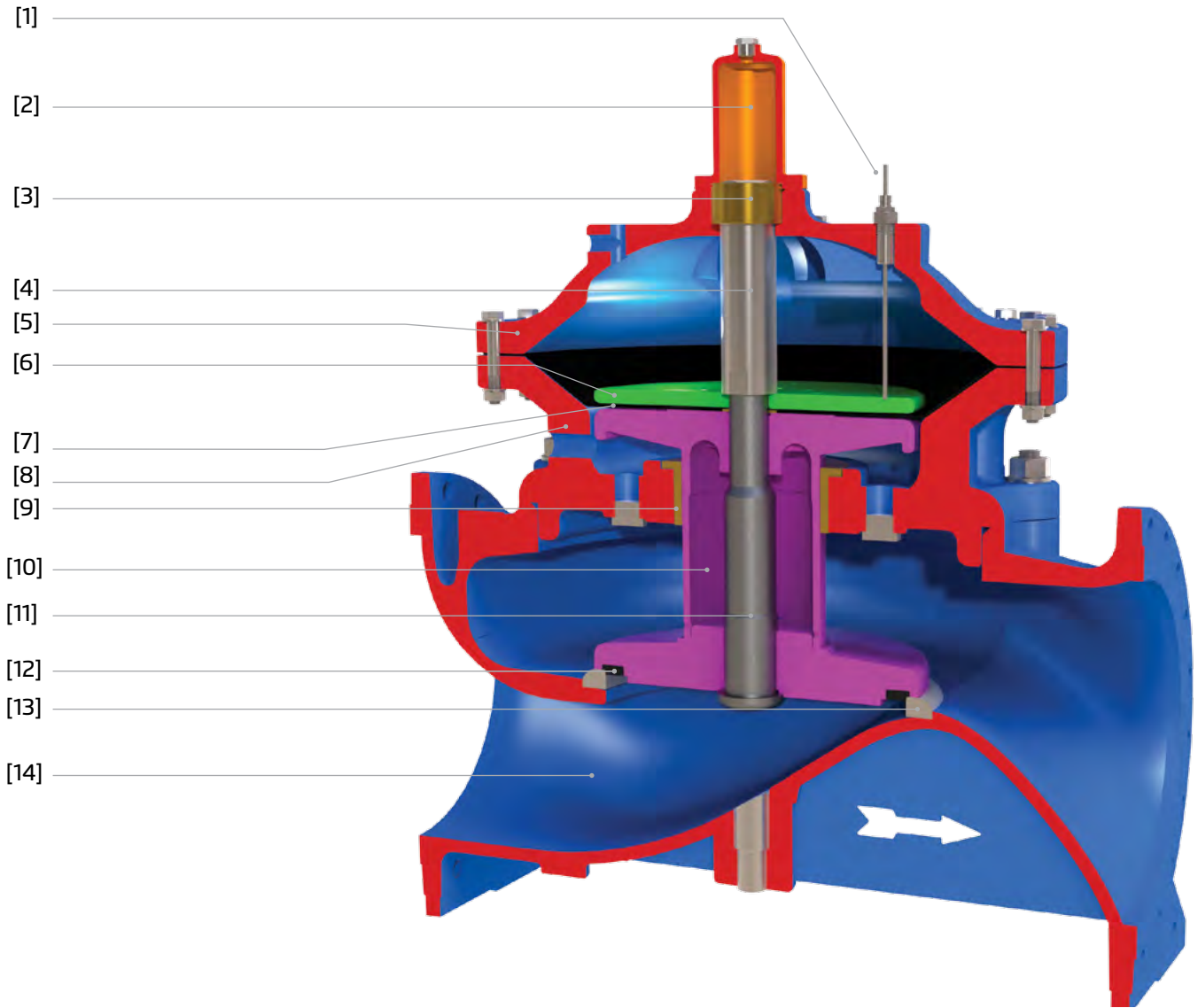

Item Number	Description	Material
1	Visual Opening Indicator	
2	Top Guide Cover	Ductile Iron
3	Top Bearing	Tin Bronze
4	Top Guide	Stainless Steel
5	Valve Cover	Ductile Iron
6	Diaphragm Top Washer	Stainless Steel
7	Diaphragm	Synthetic Rubber Nylon Fabric Reinforced
8	Separating Partition	Ductile Iron
9	Center Bearing	Tin Bronze
10	Valve Plug Assembly	Stainless Steel
11	Center Bolt	Stainless Steel
12	Closure Seal	NR or Synthetic Rubber
13	Valve Seat	Stainless Steel
14	Valve Body	Ductile Iron



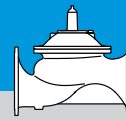

## Independent Check Feature

### Additional feature code 25

The Independent Check Feature is an integral, lift type, non slam check mechanism that opens to allow flow in the required direction and smoothly closes drip tight to prevent back flow.

The Independent Check Feature is used on various system applications such as:

- Pump control valves
- One-way level control valves
- One-way zone backup valves
- Pressure regulating valves

## Principle of Operation

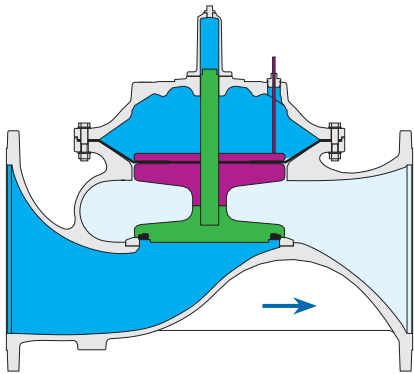

### Closed Valve

Line pressure applied to the upper control chamber of the valve creates a superior force that moves the valve to the closed position and provides drip tight sealing.

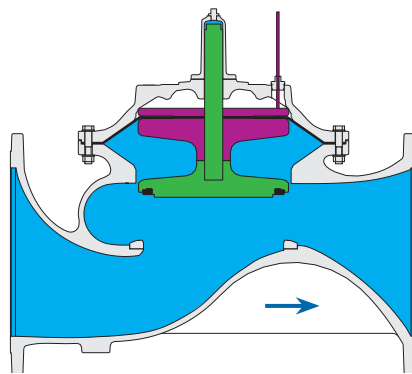

### Fully Open Valve

Discharging the pressure from the upper control chamber to atmosphere or some other lower pressure zone, causes the line pressure acting on the seal disk to move the valve to the open position.

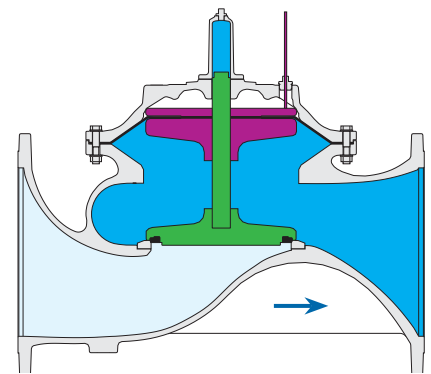

### Independent Check Closed

The independent seal disc assembly closes as soon as differential pressure force across the valve is lower than the valve plug weight, preventing reverse flow through the valve regardless of control chamber pressure and the position of the diaphragm.

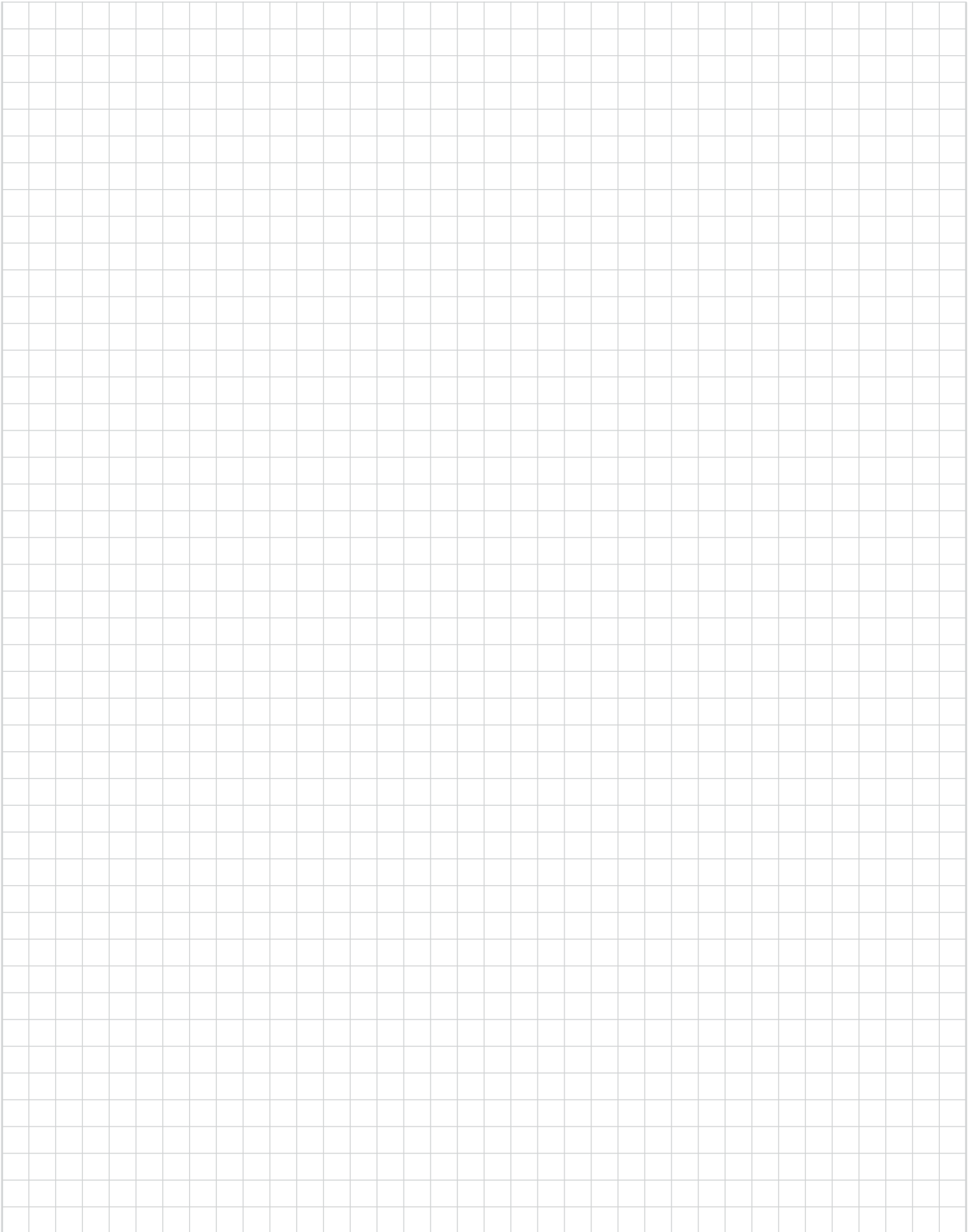
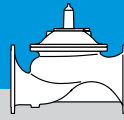

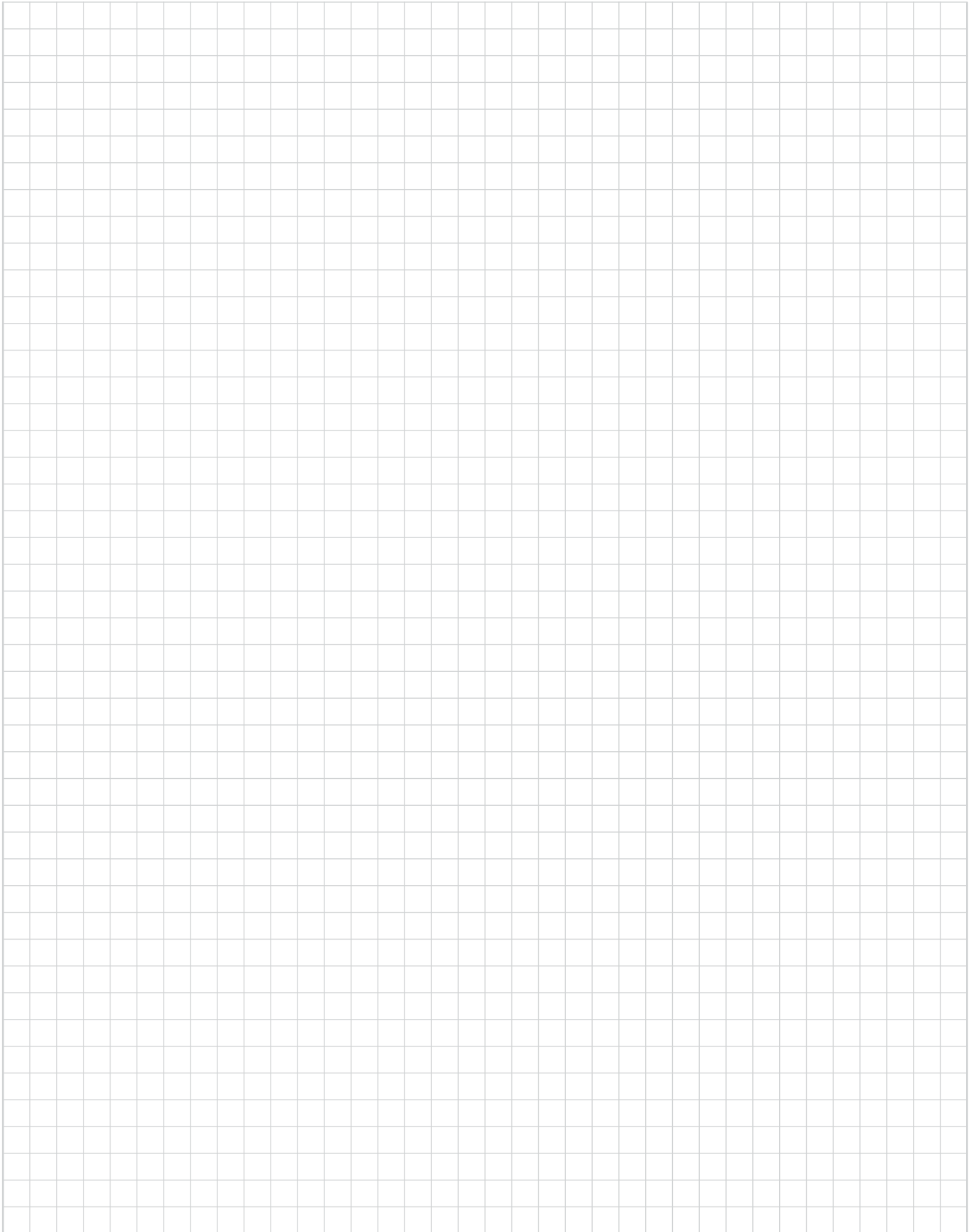
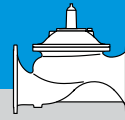



[www.bermad.com](http://www.bermad.com)

© Copyright 2008-2018 Bermad CS Ltd. All Rights Reserved. The information contained in this document is subject to change without notice. BERMAD shall not be liable for any errors contained herein.