

# 700 SIGMA SERIES

ENGINEERING DATA

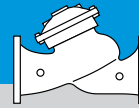

# CONTENT

<b>700 SIGMA EN/ES</b>	<b>2-8</b>
700 SIGMA EN/ES	2
Exploded View	3
Material Specifications	4
Principle of Operation	5
Plug Options	6
Cavitation	7
Cavitation Cage	8
<b>700 SIGMA EN</b>	<b>9-10</b>
Technical Data	9
Dimensions & Weights	9
Flow Factors	9
Flow Chart	10
<b>700 SIGMA ES</b>	<b>11-12</b>
Technical Data	11
Dimensions & Weights	11
Flow Factors	11
Flow Chart	12
<b>700 SIGMA EN/ES</b>	<b>13-18</b>
Additional Valve Options and Features	13
International Standards	17

# 700 SIGMA EN/ES

BERMAD 700 SIGMA EN/ES series are hydraulically operated, oblique pattern control valves with high cavitation resistance, excellent flow capacity and double chamber unitized actuator, that can be disassembled from the body as a separate integral unit.

The valves hydrodynamic body is designed for unobstructed flow path and provides excellent and highly effective modulation capacity for high differential pressure applications, with minimal noise and vibrations.

The 700 SIGMA EN/ES series meet all flange connection standards.

700 SIGMA EN – Full port valve with extraordinarily high flow capacity enabling optimized used of resources and minimizing energy costs.

700 SIGMA ES - Designed mainly for regulating applications achieving the best performance under variable flow velocities in pipes.



700 Sigma EN



700 Sigma ES

## Features and Options

- Double-Chambered Actuator
  - Actuator assembly can be removed as one integral unit.
  - Simple on-site conversion from Single to Double chambered actuator or vice versa.
- Wide Body-Oblique “Y” pattern design
 

Hydro-dynamically designed for efficient flow with minimal pressure loss and excellent resistance to cavitation. Valve port area clear of obstructions; no ribs or stem guides. Increases capacity by 25% over standard globe valves.
- Diaphragm Assembly
  - The flexible, flat fabric reinforced diaphragm is supported over the majority of its surface.
  - Diaphragm load is limited to only the stretching forces applied to the active area.
  - Diaphragm is fully protected by the separation partition from stones, wood and debris.
- Valves are suitable to work with all types of command: Hydraulic, Electric and Pneumatic.
- Self operated valves that can work without an external source of power.
- Wide range of options:
 

<ul style="list-style-type: none"> <li>■ One-way or two-way flow direction</li> <li>■ V-Port</li> <li>■ Cavitation cages (Single or Double)</li> <li>■ Visual position indicator</li> </ul>	<ul style="list-style-type: none"> <li>■ Limit switches</li> <li>■ Analog opening output</li> <li>■ Large selection of control accessories</li> </ul>
---	---

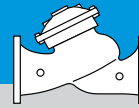

## Exploded View

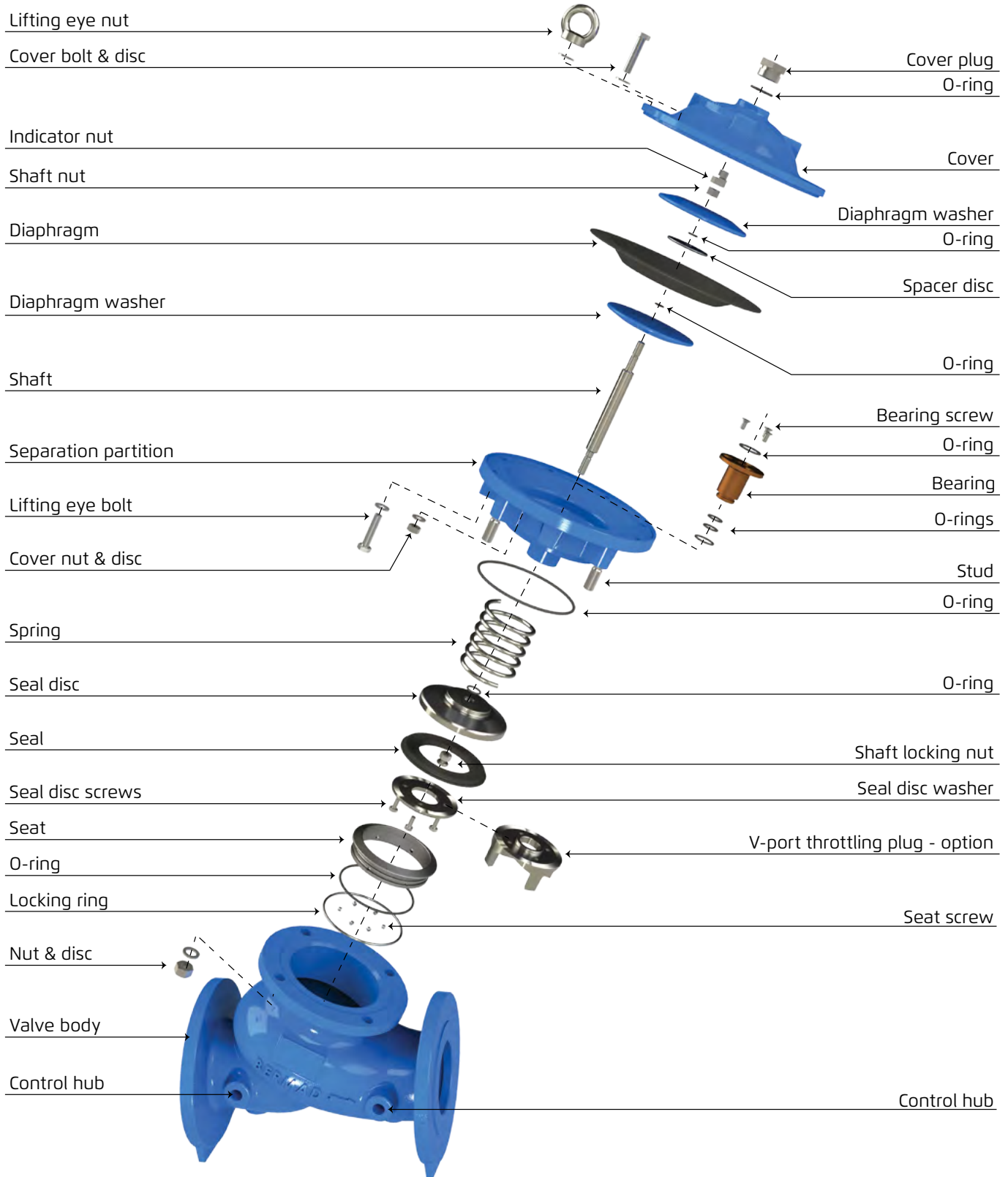

## Material Specifications

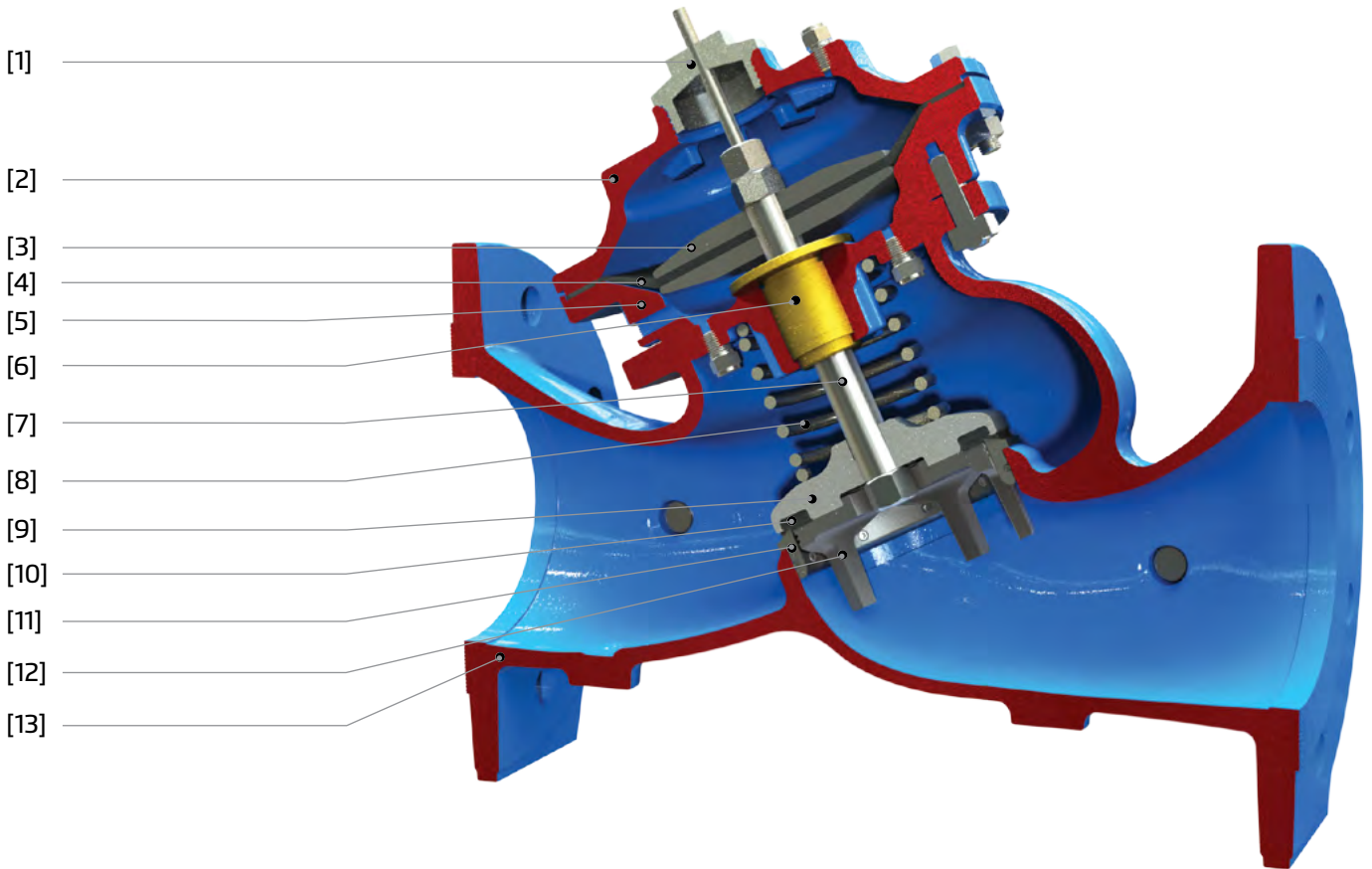

Item Number	Description	Material (Standard) *	Material (Drinking Water) *
1	Indicator Assembly (optional)	Stainless steel	
2	Cover	Fusion bonded Epoxy Coated Ductile Iron, EN 1563 or ASTM A-536	
3	Diaphragm washer	Epoxy Coated Steel	
4	Diaphragm	Fabric-reinforced NBR	Fabric-reinforced EPDM
5	Separating Partition	Fusion bonded Epoxy Coated Ductile Iron, EN 1563 or ASTM A-536	
6	Bearing	Bronze	Tin Bronze
7	Shaft	Stainless Steel, AISI 303	
8	Spring	Stainless Steel, AISI 302	
9	Seal Disc	Stainless Steel, AISI 410	
10	Seal	NBR	EPDM / NBR
11	Seat	Stainless Steel, AISI 304	
12	V-Port	Tin Bronze, Stainless Steel 316	
	Flat Disc	Stainless Steel, AISI 304	
13	Valve Body	Fusion bonded Epoxy Coated Ductile Iron, EN 1563 or ASTM A-536	
	O-Rings	NBR	EPDM
	Internal Bolts	Stainless Steel, AISI 316/304	
	External Bolts, Studs, Nuts & Disks	Stainless Steel, AISI 316	

\* Other Materials Available on Request

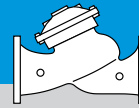

## Principle of Operation

### On-Off Modes

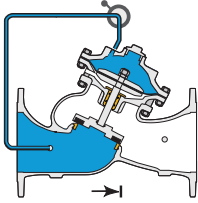

#### Closed Position

Line pressure applied to the upper control chamber of the valve creates a superior force that moves the valve to the closed position and provides drip-tight sealing

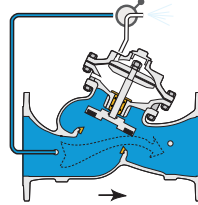

#### Open Position

Discharging the pressure in the upper control chamber to atmosphere or some other lower pressure zone causes the line pressure acting on the seal-disk to move the valve to the open position.

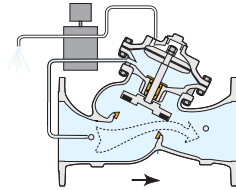

#### Powered Open Position

Line pressure is applied to the lower control chamber as pressure in the upper control chamber is vented. This, together with the line pressure acting on the seal-disk, creates a force that powers the valve to the open position.

### 3-Way Modulating Mode - Pressure Reducing

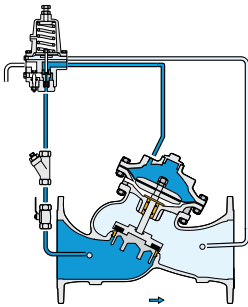

#### Closed Position

The pilot responds to high downstream pressure and introduces upstream pressure to the upper control chamber. The Double Chamber configuration ensures powered closing at zero flow.

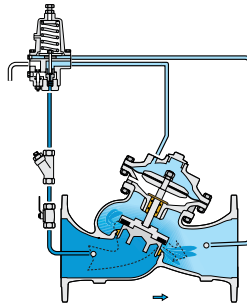

#### Modulating Position

When the downstream pressure is equal to setting, the plunger in the pilot valve moves to block all passages and freezes the valve. The pilot valve responds to downstream pressure changes and moves the valve to maintain the setting by either venting or pressurizing the control chamber.

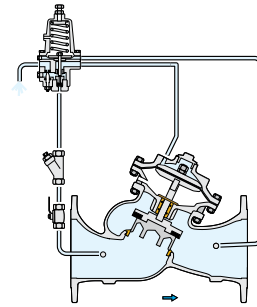

#### Open Position

When downstream pressure is lower than the setting, the plunger in the pilot valve moves to vent the pressure from the control chamber, allowing the valve to fully open. This minimizes pressure loss and ensures maximum possible downstream pressure. The 3-way control on the Double Chambered valves avoids the risk of a hydraulic lockout.

### 2-Way Modulating Mode - Pressure Reducing

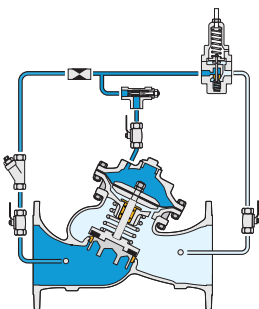

#### Closed Position

The closed adjustable pilot valve traps line pressure in the upper control chamber. The resulting superior force moves the valve to the fully closed position and provides drip-tight sealing.

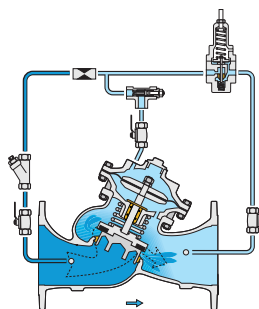

#### Modulating Position

The pilot valve senses line pressure changes and opens or closes accordingly. It controls the accumulated pressure in the valve upper control chamber, causing main valve to modulate to an intermediate position and maintain the preset pressure value.

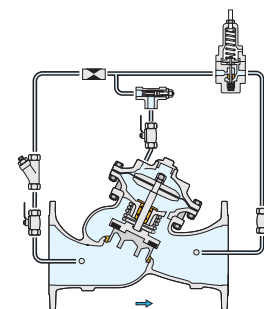

#### Open Position

The open pilot valve releases line pressure from the upper control chamber. The line pressure acting on both the lower control chamber and the seal-disk, moves the valve to the open position.

## Plug Options

BERMAD's 700 SIGMA EN/ ES series has various plug options to enable different valve characteristics.

**Flat plug** - standard plug for on-off and high flow applications.

**V-Port plug** - uniquely designed throttling plug. It changes the ratio of flow to stem travel allowing very wide flow range with relatively high pressure reduction and provides more accurate, stable and smoother response during pressure and flow regulation, while reducing noise and vibration.

BERMAD's 700 SIGMA EN/ ES series plugs can easily be change before or after valve installation on site

## Valve Plugs Characteristics

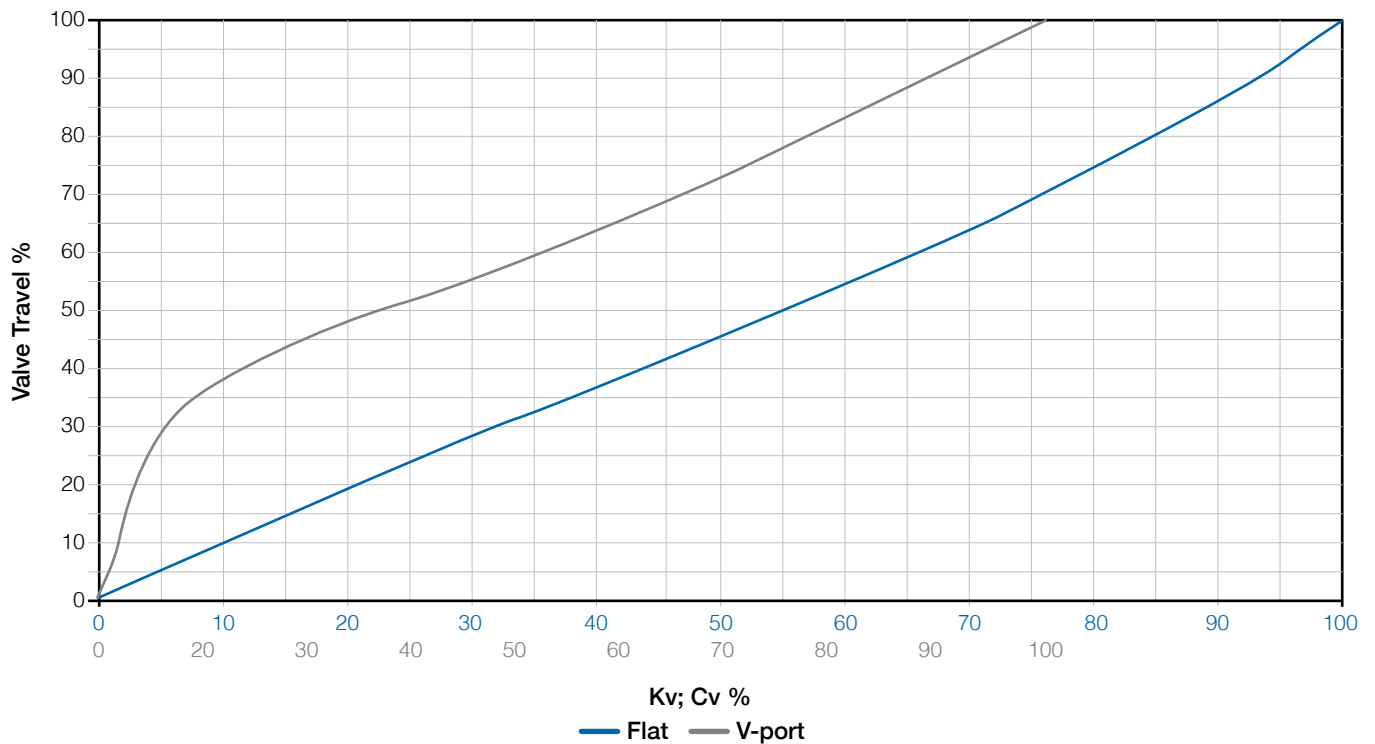

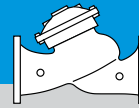

## Cavitation

The cavitation phenomenon has a significant affect on control valve and system performance.

When the fluid's static pressure reaches liquid vapor pressure, vapor cavities (bubbles) form and grow until they violently implode by the recovered pressure downstream to the valve seat.

The implosion of these cavities generates high-pressure surges, micro jets and intensive heat, which erode valve components and downstream piping. In its final stage, cavitation flashes and chokes the flow.

The Cavitation Guide is based on the formula commonly used in the valve industry:

$$\sigma = (P2 - Pv) / (P1 - P2)$$

Where:

$\sigma$  = Sigma, cavitation index, dimensionless

P1 = Upstream pressure, absolute

P2 = Downstream pressure, absolute

Pv = Liquid vapor pressure, absolute

(Water, 18°C = 0.02 bar-a ; 65°F = 0.3 psi-a)

Notes:

1. An alternate cavitation index formula introduced by ISA is:  
 $\sigma_{ISA} = (P1 - Pv) / (P1 - P2)$  which equals  $\sigma + 1$
2. The below charts should be considered only as a general guide.
3. For optimum system and control valve application please consult Bermad.

## Cavitation Charts

700 SIGMA EN US

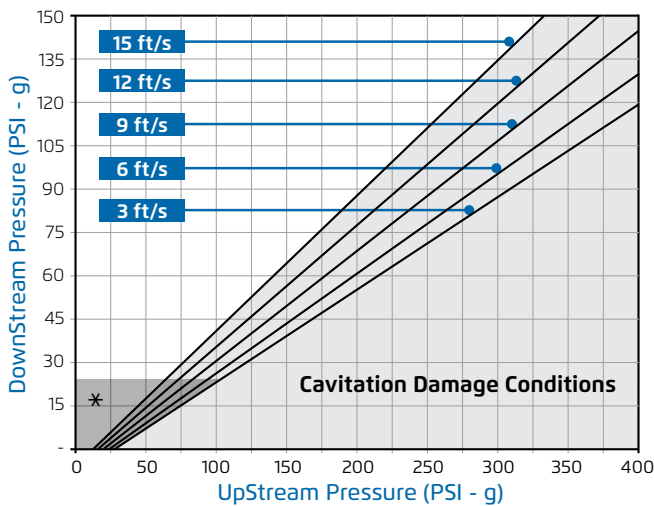

700 SIGMA ES US

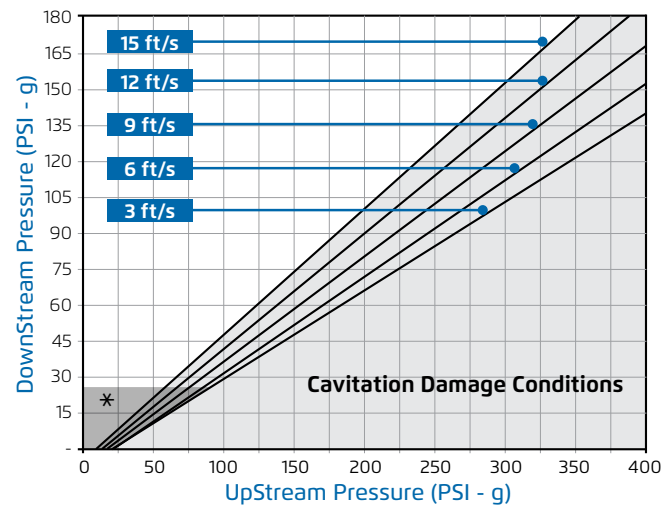

700 SIGMA EN Metric

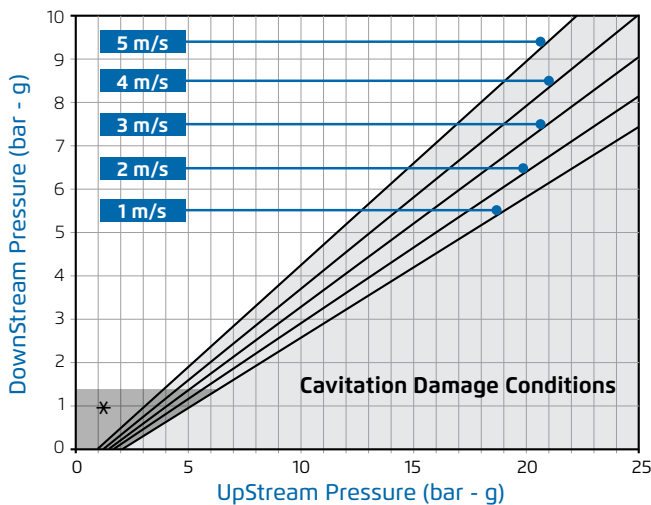

700 SIGMA ES Metric

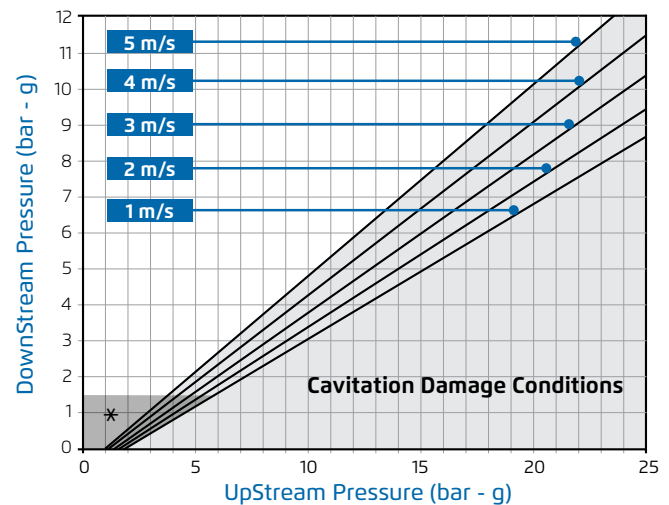

\* Consider back pressure orifice, or consult BERMAD Charts represent Flat plug



## Cavitation Cage

### Single Cavitation Cage - C1

The BERMAD Single Cavitation Cage trim is designed to reduce cavitation, noise and vibration under higher differential pressure operation, as well as smart pressure reducing.



### Double Cavitation Cage - C2

The BERMAD Double Cavitation Cage trim is designed to resist cavitation, cavitation damage, noise and vibration under extreme differential pressure operation, as well as smart pressure reducing.



## Valve Cage Characteristics

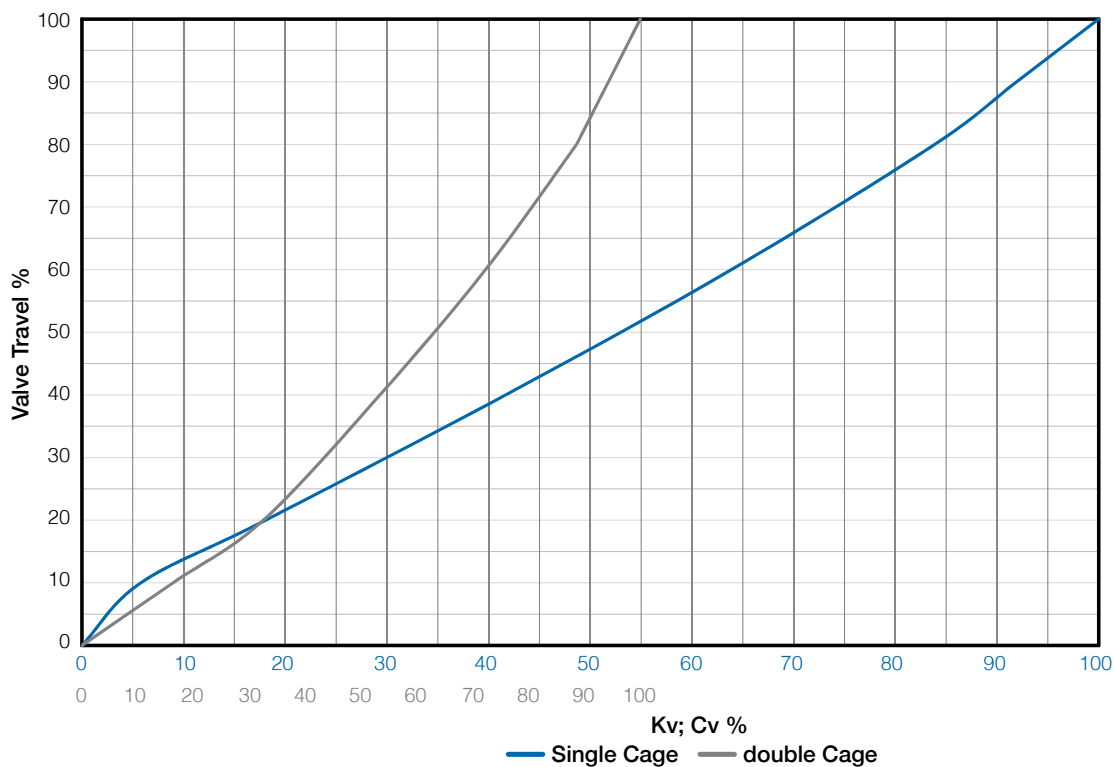

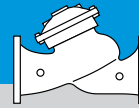

# 700 SIGMA EN

## Technical Data

**Valve Patterns:** "Y" (Globe)

**Pressure Rating:** 25 bar; 400 psi

**End Connections:** Flanged (all standards)

**Plug Types:** Flat disc, V-port, Cavitation cages

**Temperature Rating:** 60°C; 140°F for Cold water applications.

**Optional higher temperature:** Available on request

**Standard Materials:**

**Body & actuator:** Ductile Iron

**Bolts, nuts & studs:** Stainless Steel

**Internals:** Stainless Steel, Bronze & Coated Steel

**Diaphragm:** Fabric-reinforced synthetic rubber

**Seals:** Synthetic rubber

**Coating:** Dark blue Fusion bonded epoxy

For other materials contact BERMAD.

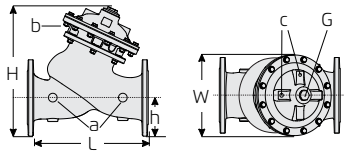

## Dimensions & Weights

Size	inch	1.5"	2"	2.5"	3"	4"	6"	8"	10"	12"	16"
	mm	40	50	65	80	100	150	200	250	300	400
L	inch	9	9	11.3	12.1	13.7	18.7	23.4	28.5	33.2	42.9
	mm	230	230	290	310	350	480	600	730	850	1100
W	inch	6	6.4	7	8.2	9.9	12.5	15.6	18.7	22.2	31.8
	mm	155	165	180	210	255	320	400	480	570	815
h*	inch	3.2	3.4	3.6	4.2	5.1	6.4	7.5	8.9	10.6	13
	mm	81	86	92	108	130	163	193	227	272	334
H*	inch	9.1	9.6	11.3	9.9	12.5	20	24.1	28.3	34.4	45.7
	mm	234	246	290	252	318	514	618	725	881	1171
Weight*	lbs	27	29	41.4	61	102	211	346	562	885	2142
	kg	12	14	20	28	47	96	158	256	403	974
Control Chamber Volume	Gallons	0.03	0.03	0.08	0.08	0.12	0.57	1.19	2.24	3.27	7.87
	Litres	0.125	0.125	0.3	0.3	0.45	2.15	4.5	8.5	12.4	29.8
Valve travel	inch	0.63	0.63	0.87	0.98	1.06	1.97	2.44	2.76	3.94	5.28
	mm	16	16	22	25	27	50	62	70	100	134
a	inch	3/8" NPT						1/2" NPT		1" BSP	
b	inch	1/8" NPT				1/4" NPT			3/8" NPT		3/4" BSP
c	inch	1/4" NPT						1/2" NPT		3/4" BSP	
G	inch	3/4" G				2" G			3" G		

\* Maximum Dimensions

## Flow Factors

Size	inch	1.5"	2"	2.5"	3"	4"	6"	8"	10"	12"	16"
	mm	40	50	65	80	100	150	200	250	300	400
Flat Disc	Cv	66	72	113	150	231	624	1045	1709	2472	3812
	Kv	57	62	98	130	200	540	905	1480	2140	3300
	K	1.2	2.6	2.9	3.8	3.9	2.7	3.1	2.8	2.8	2.7
V-Port	Cv	53	55	84	118	162	523	886	1513	2241	3430
	Kv	46	48	73	102	140	453	767	1310	1940	2970
	K	1.9	4.3	5.3	6.2	8.0	3.9	4.3	3.6	3.4	4.6

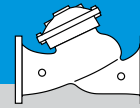

## Flow Chart

### US Units

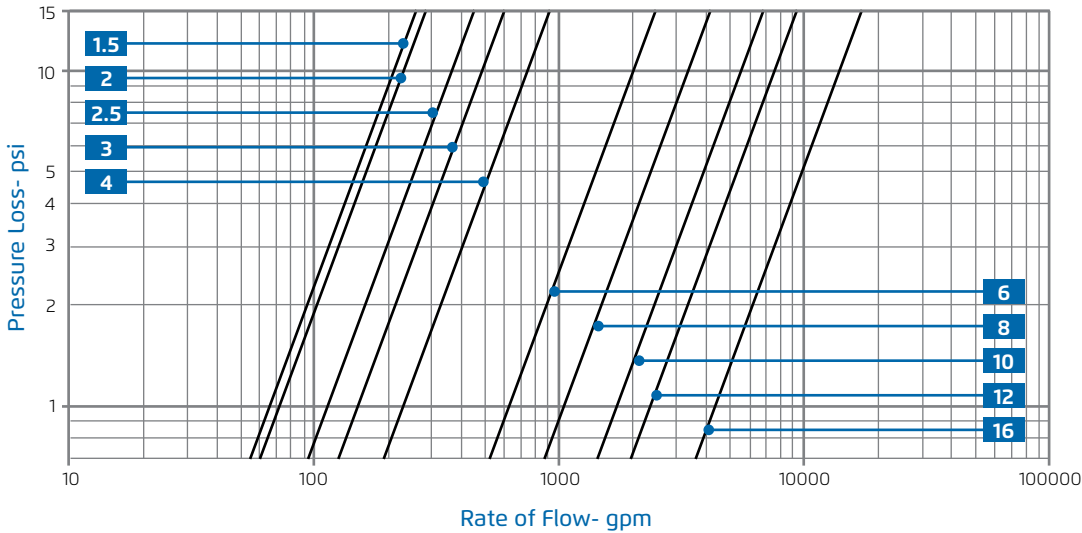

### Metric

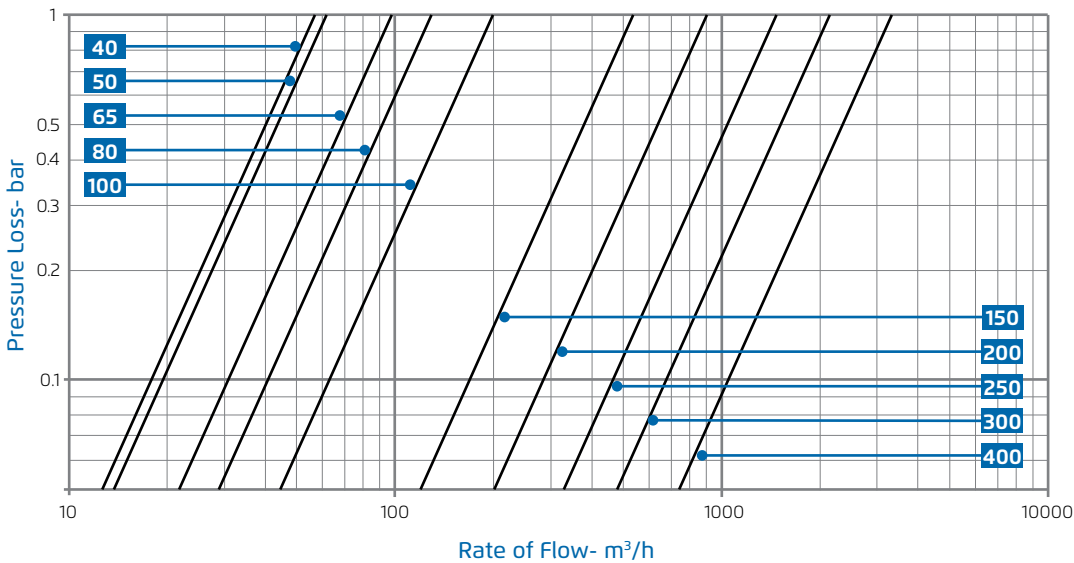

\* Charts represents fully open valves. Use BERMAD Sizing program for proper valve sizing.

### Differential Pressure & Flow Calculation

$$Cv = \frac{Q}{\sqrt{\Delta P}}$$

$$Q = Cv * \sqrt{\Delta P}$$

$$\Delta P = \left(\frac{Q}{Cv}\right)^2$$

$$Kv = \frac{Q}{\sqrt{\Delta P}}$$

$$Q = Kv * \sqrt{\Delta P}$$

$$\Delta P = \left(\frac{Q}{Kv}\right)^2$$

Cv = Valve flow coefficient (flow in gpm at ΔP=1psi)

Q = Flow rate (gpm)

ΔP = Differential pressure (psi)

Kv = 0.866 \* Cv

Kv = Valve flow coefficient (flow in m3/h at ΔP=1bar)

Q = Flow rate (m3/h)

ΔP = Differential pressure (bar)

Cv = 1.155 \* Kv

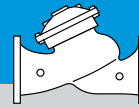

# 700 SIGMA ES

## Technical Data

**Valve Patterns:** "Y" (Globe)

**Pressure Rating:** 25 bar; 400 psi

**End Connections:** Flanged (all standard)

**Plug Types:** Flat disc, V-port, Cavitation cages

**Temperature Rating:** 60°C; 140°F for Cold water applications.

**Optional higher temperature:** Available on request

**Bolts, nuts & studs:** Stainless Steel

**Internals:** Stainless Steel, Tin Bronze & Coated Steel

**Diaphragm:** Fabric-reinforced synthetic rubber

**Seals:** Synthetic rubber

**Coating:** Dark blue Fusion bonded epoxy

For other materials contact BERMAD.

**Standard Materials:**

**Body & actuator:** Ductile Iron

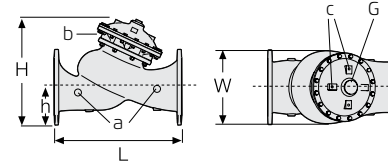

## Dimensions & Weights

Size	inch	2.5"	3"	4"	5"	6"	8"	10"	12"	14"	16"	18"	20"	24"	
	mm	65	80	100	125	150	200	250	300	350	400	450	500	600	
L	inch	11.3	12.1	13.7	15.8	18.7	23.4	28.5	33.2	38.2	42.9	46.8	48.8	56.6	
	mm	290	310	350	400	480	600	730	850	980	1100	1200	1250	1450	
W	inch	7.4	8.2	9.9	10.6	12.5	14.8	17.6	21.1	22.8	25.7	31.8	32	36	
	mm	190	210	255	270	320	380	450	540	585	660	815	815	920	
h*	inch	3.8	4.2	5.1	5.5	6.4	7.5	8.9	10.3	11.7	13	14.1	16	19	
	mm	98	108	130	140	163	193	227	265	299	334	361	398	490	
H*	inch	9.4	9.8	12.4	14.7	16.0	19.7	23.4	28.1	35.5	36.8	46.6	48	49	
	mm	242	252	318	375	411	506	600	721	909	943	1195	1220	1240	
Weight*	lbs	39	48	82	133	172	273	435	673	1006	1132	2253	2386	2838	
	kg	18	22	38	62	78	125	198	306	457	515	1024	1085	1290	
Control Chamber Volume	Gallons	0.03	0.03	0.08	0.12	0.13	0.57	1.19	2.24	3.27	7.87	7.87	7.87	7.87	
	Litres	0.125	0.125	0.3	0.45	0.5	2.15	4.5	8.5	12.4	29.8	29.8	29.8	29.8	
Valve Travel	inch	0.63	0.87	0.98	1.06	1.61	1.97	2.44	2.75	3.94	3.94	5.28	5.28	5.28	
	mm	16	22	25	27	41	50	62	70	100	100	134	134	134	
a	inch	3/8" NPT					1/2" NPT					1" BSP			
b	inch	1/8" NPT			1/4" NPT				3/8" NPT				3/4" BSP		
c	inch	1/4" NPT						1/2" NPT				3/4" BSP			
G	inch	3/4" G				2" G						3" G			

\* Maximum Dimensions    \*\* For 24", the dimensions is without the sizes of cradle

## Flow Factors

Size	inch	2.5"	3"	4"	5"	6"	8"	10"	12"	14"	16"	18"	20"	24"
	mm	65	80	100	125	150	200	250	300	350	400	450	500	600
Flat Disc	Cv	69	75	165	248	456	705	1045	1756	2472	2599	3812	3812	3812
	Kv	60	65	143	215	395	610	905	1520	2140	2250	3300	3300	3300
	K	7.8	15.2	7.7	8.3	5.1	6.7	7.5	5.5	5.1	7.9	5.9	9.0	18.7
V-Port	Cv	59	64	142	211	388	599	888	1492	2145	2341	3430	3430	3430
	Kv	51	55	123	183	336	519	769	1292	1857	2027	2970	2970	2970
	K	10.8	21.2	10.4	11.4	7.0	9.3	10.4	7.6	6.8	9.8	7.3	11.1	23.0



## Flow Chart

### US Units

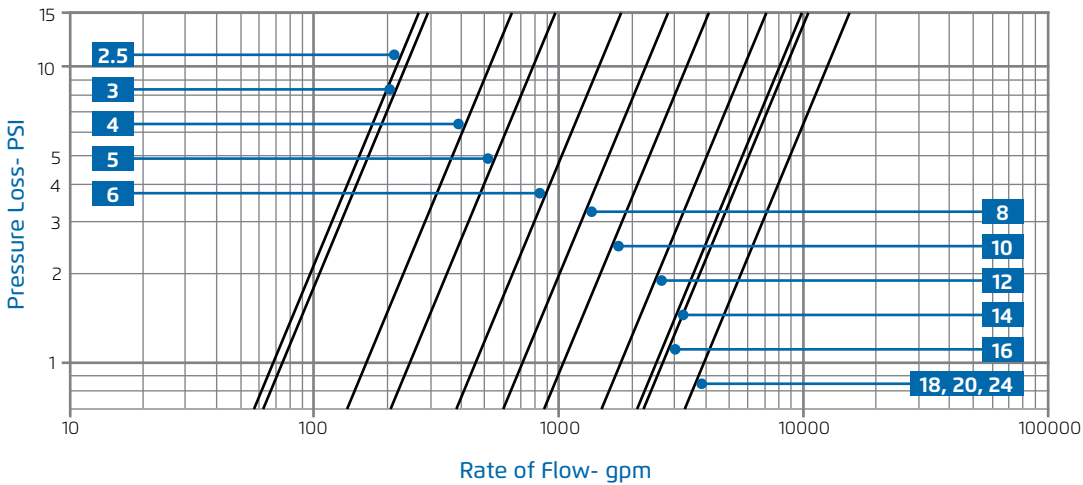

### Metric

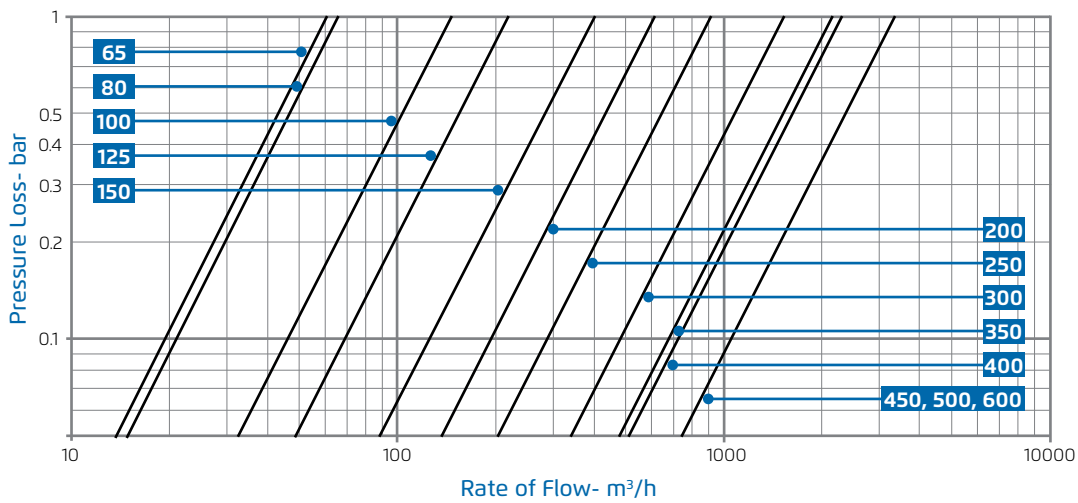

\* Charts represents fully open valves. Use BERMAD Sizing program for proper valve sizing.

### Differential Pressure & Flow Calculation

$$Cv = \frac{Q}{\sqrt{\Delta P}}$$

$$Q = Cv * \sqrt{\Delta P}$$

$$\Delta P = \left(\frac{Q}{Cv}\right)^2$$

$$Kv = \frac{Q}{\sqrt{\Delta P}}$$

$$Q = Kv * \sqrt{\Delta P}$$

$$\Delta P = \left(\frac{Q}{Kv}\right)^2$$

Cv = Valve flow coefficient (flow in gpm at ΔP=1psi)

Q = Flow rate (gpm)

ΔP = Differential pressure (psi)

Kv = 0.866 \* Cv

Kv = Valve flow coefficient (flow in m³/h at ΔP=1bar)

Q = Flow rate (m³/h)

ΔP = Differential pressure (bar)

Cv = 1.155 \* Kv

# 700 SIGMA EN/ES

## Additional Valve Options and Features

### Independent Lift Check - 2S

The BERMAD Independent Lift Check feature is an integral, lift type, spring loaded non return trim that allow full control and regulation in the required direction and smoothly closes drip tight before flow changes direction, regardless of control status.



### Back-up Safety - TC

The BERMAD Back-up Safety feature is a Triple Chamber actuated valve, where the third control chamber enables a failsafe mechanism and is recommended in critical or sensitive water systems to ensure continuous operation of the system.



### Insertion Flow Meter - MT

The BERMAD Insertion Flow Meter can be inserted into the upstream side of the 700-Sigma EN/ES valves, adding accurate flow measurement function.



**Valve Position Indicator - I**

The BERMAD Valve Position Indicator Assembly provides a visual indication of valve opening and regulation behavior.



**Single Limit Switch - S**

The BERMAD Single Limit Switch Assembly includes mechanical electrical change over contacts (NO + NC), enabling remote signaling of the closed valve position.



**Double Limit Switch - SS**

The BERMAD Double Limit Switch Assembly includes two mechanical electrical switches, enabling remote signaling of the closed and the open valve positions.



**Flow Stem - M**

The BERMAD Flow Stem Assembly enables limiting the opening stroke of the control valve or for safety ensured mechanical closure.



**Lifting Spring - L**

The BERMAD Lifting Spring Assembly enables the valve to remain open at zero pressure conditions and to minimize pressure losses.



**Analog Valve Position Transmitter - Q**

The BERMAD Analog Valve Position Transmitter Assembly enables remote signaling of the valve's relative position.





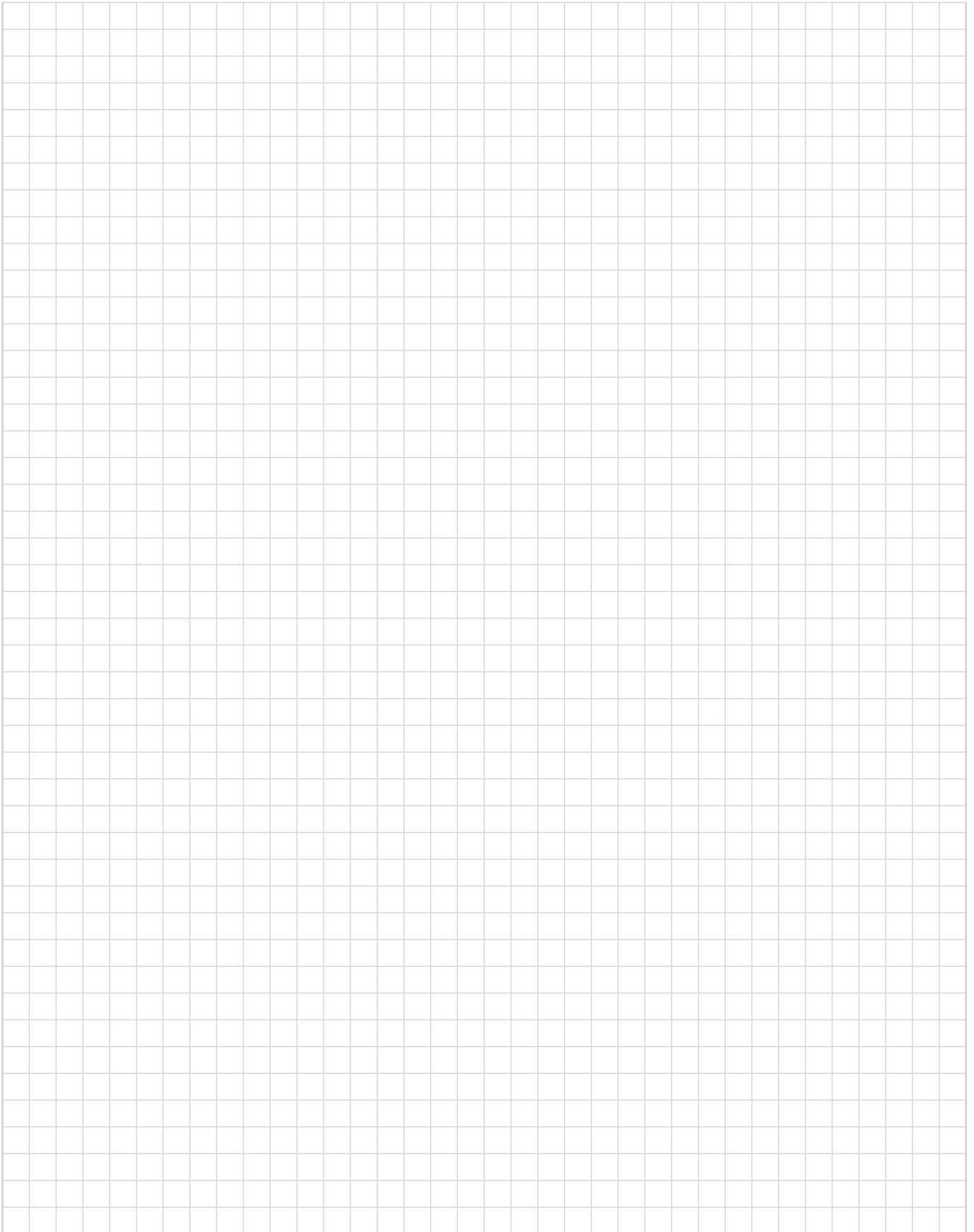
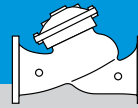

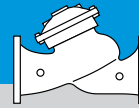

## International Standards

	INTERNATIONAL	ISO 9001-2015 Certified Quality Assurance System
ISO 9001	INTERNATIONAL	ISO 9001-2015 Certified Quality Assurance System
	WRAS, UK	The product complies with the Water Regulation Advisory Scheme of UK and BS 6920
	DVGW, Germany	Compliance with the European Standard EN 1074 – Valves for water supply and German Standards KTW and W270
	ACS, France	Tests are based on the French Sanitary standard
	BELGAQUA, Belgium	The product complies with the Belgian Standards for materials in contact with drinking water
	NSF USA	The product complies with the NSF/ ANSI 61 Std. – Valves for Water Supply and NSF 372 low lead
	Bulgarcontrola, Bulgaria	Compliance of Bermad Automatic Control Valves with the sanitary requirements of Bulgaria and with the EN 1074 European Standard for Valves for Water Supply
	PZH, Poland	Compliance of Bermad Automatic Control Valves with the Polish sanitary requirements
	AUSTRALIA AS 5081 and water mark	Control valves for waterworks purposes
	RUSSIAN Customs Union	Valves For Water Supply
	KOREA	Valves For Water Supply

BERMAD valves comply with a wide range of international standards. Please consult with BERMAD about the compliance of a required model to a specific standard

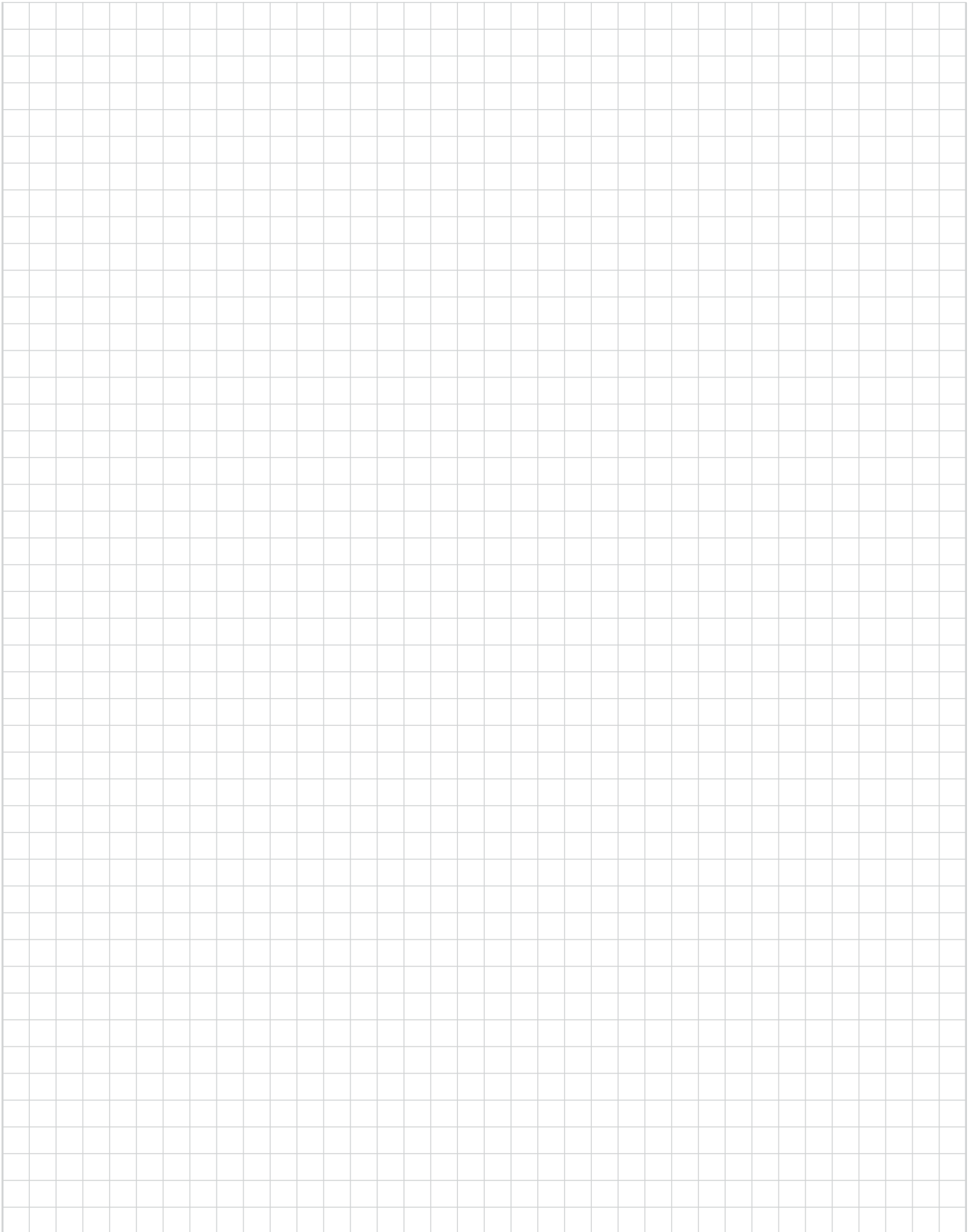
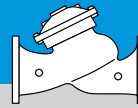



[www.bermad.com](http://www.bermad.com)

© Copyright 2008-2018 Bermad CS Ltd. All Rights Reserved. The information contained in this document is subject to change without notice. BERMAD shall not be liable for any errors contained herein.