

Pressure Reducing Valve

Model 720

- Flow and leakage reduction
- Cavitation damage protection
- Throttling noise reduction
- Burst protection
- System maintenance savings

The Model 720 Pressure Reducing Valve is a hydraulically operated, diaphragm actuated control valve that reduces higher upstream pressure to lower constant downstream pressure regardless of fluctuating demand or varying upstream pressure.



Features and Benefits

- **Designed to** – stand up to the toughest conditions
 - Excellent anti-cavitation properties
 - Silent operation suitable for urban and high rise applications
 - Wide flow range
 - High stability and accuracy
- **Double chamber design**
 - Moderated valve reaction
 - Protected diaphragm
- **Flexible design** – Easy addition of features
- **Obstacle free, full bore** – Free flow pass
- **V-Port Throttling Plug** – Very stable at low flow
- **Complies with EN-1074 standards**
 - High quality materials
 - Stainless steel trim components
- **In-line serviceable** – Easy maintenance

Major Additional Features

- Pressure management valve – **7PM**
- Solenoid control – **720-55**
- Check valve – **720-20**
- Solenoid control & check valve – **720-25**
- Proportional – **720-PD**
- High sensitivity pilot – **720-12**
- Downstream over pressure guard – **720-48**
- Electrically selected multi-level setting – **720-45**
- Electronic multi-level setting, Type 4T – **720-4T**
- Electronic pressure reducing valve – **728-03**

See relevant BERMAD publications.

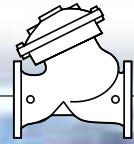

Operation

The Model 720 is a pilot controlled valve equipped with an adjustable, 2-way pressure reducing pilot. The restriction [1] continuously allows flow from the valve inlet into the upper control chamber [2]. The pilot [3] senses downstream pressure. Should this pressure rise above pilot setting, the pilot throttles, enabling pressure in the upper control chamber to accumulate, causing the main valve to throttle closed, decreasing downstream pressure to pilot setting. Should downstream pressure fall below pilot setting, the pilot releases accumulated pressure, and the main valve modulates open. The V-Port plug (optional) [4] increases the ratio of flow to stem travel, providing more accurate, stable and smooth regulation. The integral orifice between the lower control chamber and valve outlet moderates valve reactions. The one-way flow control needle valve [5] stabilizes the valve's reaction in hard regulation conditions, by restricting the flow out of the control chamber. The downstream cock valve [6] enables manual closing.

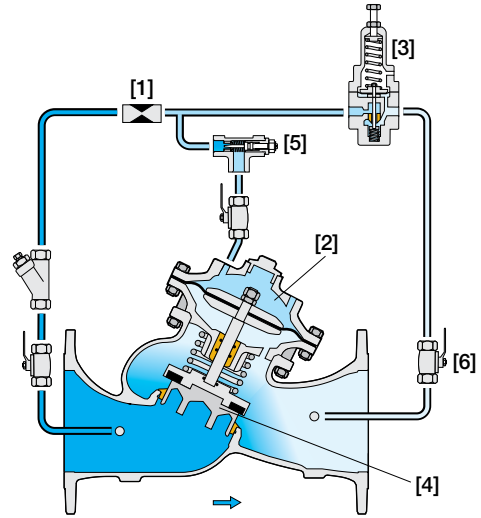

Pilot System Specifications

Standard Materials:

Pilot:

Body: Stainless Steel 316 or Bronze
 Elastomers: Synthetic Rubber
 Spring: Galvanized Steel or Stainless Steel

Tubing & Fittings:

Stainless Steel 316 or Copper & Brass

Accessories:

Stainless Steel 316, Brass and Synthetic Rubber Elastomers

Pilot Adjustment Range:

- 0.5 to 3.0 bar ; 7 to 40 psi
- 0.8 to 6.5 bar ; 11 to 95 psi
- 1 to 16 bar ; 15 to 230 psi
- 5 to 25 bar ; 70 to 360 psi

Notes:

- Inlet pressure, outlet pressure and flow rate are required for optimal sizing and cavitation analysis
- Recommended continuous flow velocity: 0.1-6.0 m/sec ; 0.3-20 ft/sec
- Minimum operating pressure: 0.7 bar ; 10 psi. For lower pressure requirements consult factory

Cavitation Chart

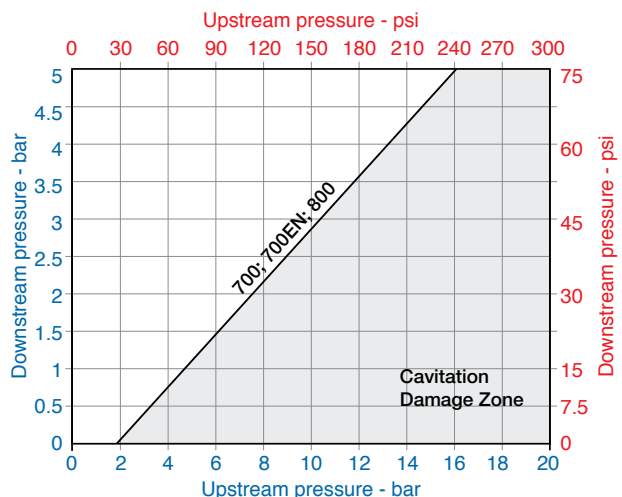
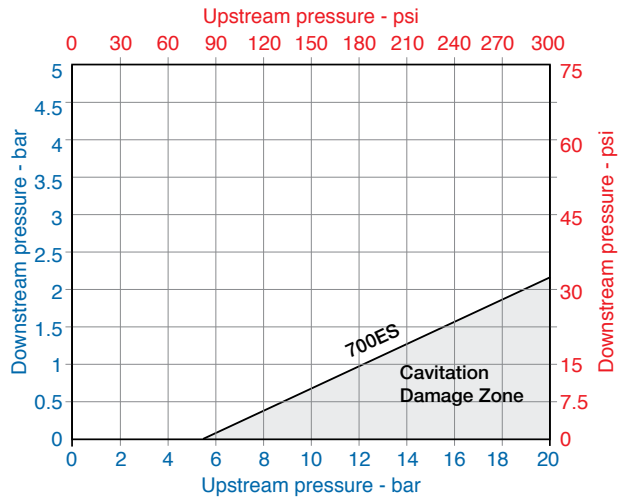

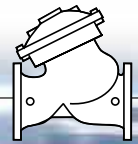

Pressure Management

A well-planned pressure management program can significantly reduce not only volumes of real loss, but also maintenance costs by reducing occurrence of bursts and thereby extending the life of the system.

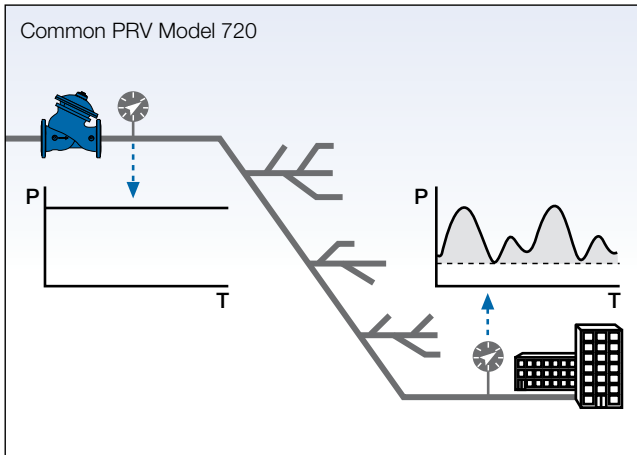

Common PRVs are set to maintain a constant low downstream pressure, ensuring sufficient pressure at the system's critical point during peak demand (when line friction head loss is highest). The shaded area represents the hours and levels when pressure is higher than required.

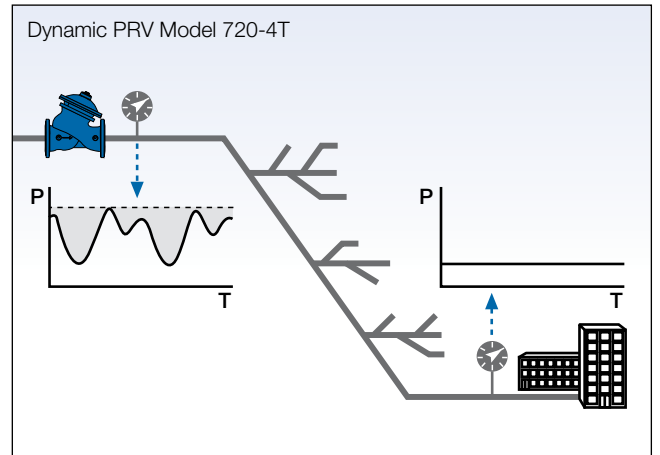

The dynamic PRV - Model 720-4T, integrated with a PR controller, is designed to continuously correct its set value based on the momentary demand and/or minimum required pressure at the system critical point. As a result, the average network pressure dramatically decreases, reducing system leakage, bursts, maintenance, and energy costs. The shaded area represents the hours and levels of reduced leakage.

Flow Function Control

Data logging and analysis of the distribution network parameter values, enable establishment of a function for real time adjustment of pressure per system demand. The flow and pressure transducers continuously transmit to the controller, which reacts by adjusting the Model 720-4T according to the pre-established function. The controller's program can be changed either through a laptop computer or a pocket PC, SMS, or any other communication method available.

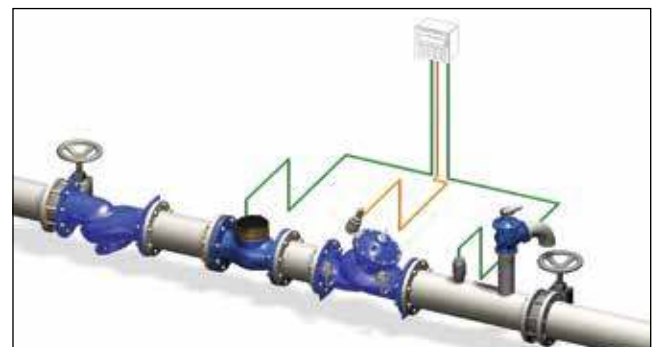

Time Function Control

The PRV model 720-45 integrated with the BE-PRV-DL controller is designed to maintain two pressure reducing set-point values. The BE-PRV-DL controller is programmed to switch between the two pilot valves and therefore change the pressure reducing set-point. The BE-PRV-DL control program can adapt to special days, or seasons of the year, as well as log pressure and flow data.





Pressure-Reducing Systems in Hi-Rise Buildings

Water supply system design requirements for hi-rise buildings present unique issues:

- Supply cut-off is unacceptable and single-source supply is common.
- Valves are located in areas where water damage can be extremely expensive.
- Pressure-reducing systems are often located next to prestigious residential and office space. Extraneous noise and maintenance activities are to be avoided.
- The main supply line of hi-rise buildings is exposed to greater head at lower zones while pressure for the consumer must be kept within recommended levels. As a result, lower zone pressure reducing systems deal with greater differential pressure.

The Model 720 Pressure Reducing Valve together with BERMAD'S accumulated experience, address these issues and provide appropriate solutions.

Higher-Zone Installation **A**

In addition to the standard pressure reducing system, for a hi-rise building, BERMAD recommends the system also include Pressure Switches to signal a control panel of excessive downstream pressure.

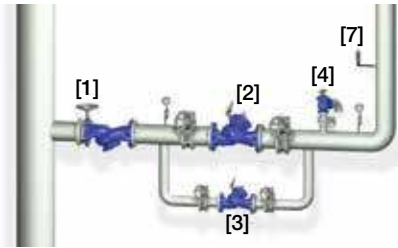

Lower Zone (Two-Stage) Installation **B**

When dealing with high differential pressure systems in lower zones of a hi-rise building, BERMAD recommends a two-stage pressure reducing system. In addition to the typical higher zone installation, this high differential pressure system also includes: Proportional Pressure Reducing Valve Model 720, as the first pressure reducing stage, absorbs part of the high differential pressure. By spreading the load of pressure reduction on to two components, cavitation damage and noise are reduced.

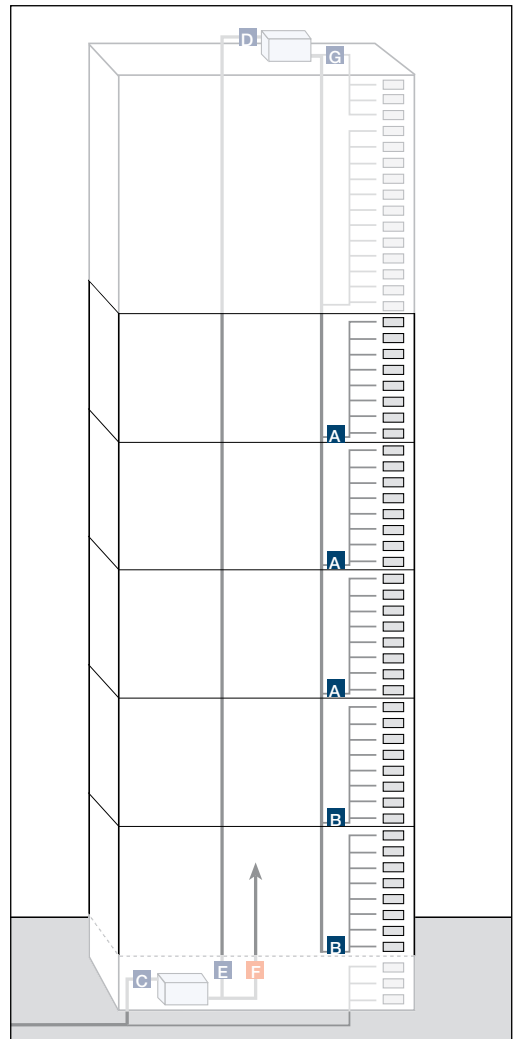
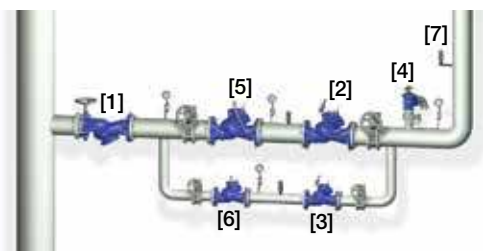

- [1] Strainer Model 70F
- [2] Pressure Reducing Valve Model 720
- [3] By-pass Pressure Reducing Valve Model 720
- [4] Relief Valve Model 73Q
- [5] Proportional Pressure Reducing Valve Model 720-PD
- [6] By-Pass Proportional Pressure Reducing Valve Model 720-PD
- [7] Pressure Switch

- A** Higher zone pressure reducing system installation
- B** Lower zone pressure reducing system (two-stage) installation
- C** Bottom reservoir level control system
- D** Roof reservoir level control system
- E** Potable water pumping system
- F** Fire protection pumping system
- G** Upper floors pumping system

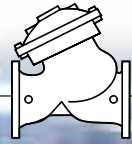

Typical Applications

Pressure Reducing System for Municipal Networks

Network design requires establishing various pressure zones due to topography, distances, demands, energy costs, reservoir availability, etc.

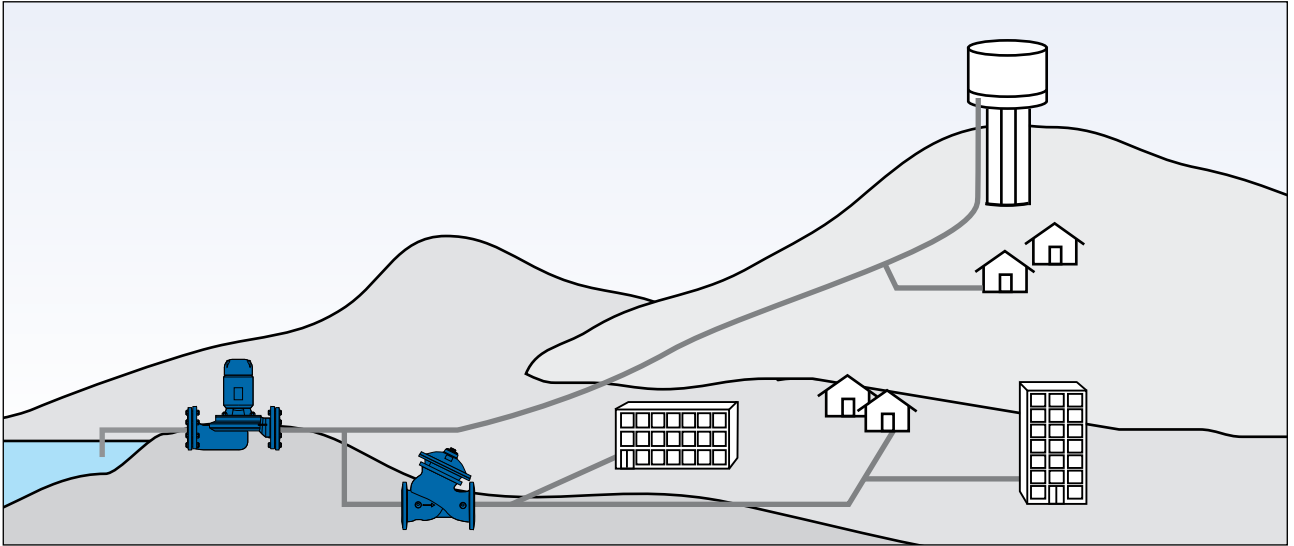

The pump supplies water to the network and to the reservoir. System pressure is too high for the residential neighborhood, requiring a pressure reducing system.

Pressure Reducing System – Typical Installations

Standard Pressure Reducing System **A**

In addition to the **Model 720 Pressure Reducing Valve**, BERMAD recommends that the system also include:

- **Strainer Model 70F** prevents debris from damaging valve operation
- **Relief Valve Model 73Q** provides:
 - Protection against momentary pressure peaks
 - Visual indication of need for maintenance
- **By-Pass Pressure Reducing Valve** saves on maintenance costs. The larger (more costly to maintain) valve operates during peak demand. The smaller by-pass valve cuts operating hours of the larger valve, achieving greater return on investment.



High Differential Pressure Reducing Systems **B**

First stage reduction is achieved by using the proportional pressure reducing valve model 720-PD. This reduces cavitation damage and noise level by distributing the load of the high differential pressure.

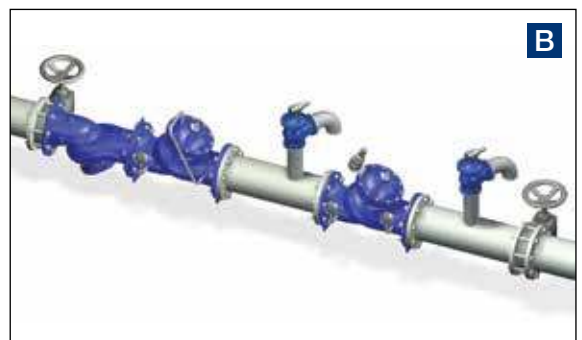

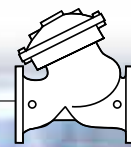

700 Series

Technical Data

Size Range: DN40-900 ; 1½-36"
End Connections (Pressure Ratings):
Flanged: ISO PN16, PN25 (ANSI Class 150, 300)
Threaded: BSP or NPT
Others: Available on request
Valve Patterns: "Y" (globe) & angle, globe (DN600-900 ; 24"-36")
Working Temperature: Water up to 80°C ; 180°F
Standard Materials:
Body & Actuator: Ductile Iron
Internals: Stainless Steel, Bronze & coated Steel
Diaphragm: Synthetic Rubber Nylon fabric-reinforced
Seals: Synthetic Rubber
Coating: Fusion Bonded Epoxy, RAL 5005 (Blue) approved for drinking water or Electrostatic Polyester Powder

Differential Pressure Calculation

$$\Delta P = \left(\frac{Q}{Kv; Cv} \right)^2$$

ΔP = Differential Pressure for fully open valve (bar; psi)
Q = Flow rate (m³/h; gpm)
Kv = Metric system - valve flow coefficient (flow in m³/h at 1 bar ΔP with 15°C water)
Cv = US system - Valve flow coefficient (flow in gpm at 1 psi ΔP with 60°F water)
 Cv = 1.155 Kv

Flow Data & Dimensions Table

DN / Size		40	1.5"	50	2"	65	2.5"	80	3"	100	4"	150	6"	200	8"	250	10"	300	12"	350	14"	400	16"	450	18"	500	20"
Flow Data 700 & 700ES 700EN	Kv / Cv - Flat	54	62	57	66	60	69	65	75	145	167	395	456	610	705	905	1,045	1,520	1,756	-	-	2,250	2,599	-	-	4,070	4,701
	Kv / Cv - V-Port	46	53	48	56	51	59	55	64	123	142	336	388	519	599	769	888	1,292	1,492	-	-	1,913	2,209	-	-	3,460	3,996
	Kv / Cv - "Y" Flat	42	49	50	58	55	64	115	133	200	230	460	530	815	940	1,250	1,440	1,850	2,140	1,990	2,300	3,310	3,820	3,430	3,960	3,550	4,100
	Kv / Cv - "Y" V-Port	36	41	43	49	47	54	98	113	170	200	391	450	693	800	1,063	1,230	1,573	1,820	1,692	1,950	2,814	3,250	2,916	3,370	3,018	3,490
700-ES PN16; 25	L (mm / inch)	230	9.1	230	9.1	290	11.4	310	12.2	350	13.8	480	18.9	600	23.6	730	28.7	850	33.5	-	-	1,100	43.3	-	-	1,250	49.2
	W (mm / inch)	150	5.9	165	6.5	185	7.3	200	7.9	235	9.3	300	11.8	360	14.2	425	16.7	530	20.9	-	-	626	24.6	-	-	838	33
	h (mm / inch)	80	3.1	90	3.5	100	3.9	105	4.1	125	4.9	155	6.1	190	7.5	220	8.7	250	9.8	-	-	320	12.6	-	-	385	15.2
	H (mm / inch)	240	9.4	250	9.8	250	9.8	260	10.2	320	12.6	420	16.5	510	20.1	605	23.8	725	28.5	-	-	895	35.2	-	-	1,185	46.7
700-EN PN16; 25	Weight (Kg/lb)	10	22	10.8	23.8	13.2	29	15	33	26	57.2	55	121	95	209	148	326	255	561	-	-	437	960	-	-	1,061	2,334
	L (mm / inch)	-	-	-	-	-	-	310	12.2	350	13.8	480	18.9	600	23.6	730	28.7	850	33.5	-	-	-	-	-	-	-	-
	W (mm / inch)	-	-	-	-	-	-	200	7.9	235	9.3	320	12.6	390	15.4	480	18.9	550	21.7	-	-	-	-	-	-	-	-
	h (mm / inch)	-	-	-	-	-	-	100	3.9	118	4.6	150	5.9	180	7.1	213	8.4	243	9.6	-	-	-	-	-	-	-	-
700 Flanged "Y" PN16 Class 150	H (mm / inch)	-	-	-	-	-	-	305	12	369	14.5	500	19.7	592	23.3	733	28.9	841	33.1	-	-	-	-	-	-	-	-
	Weight (Kg/lb)	-	-	-	-	-	-	21	46.2	31	68.2	70	154	115	253	198	436	337	741	-	-	-	-	-	-	-	-
	L (mm / inch)	205	8.1	210	8.3	222	8.7	250	9.8	320	12.6	415	16.3	500	19.7	605	23.8	725	28.5	733	28.9	990	39	1,000	39.4	1,100	43.3
	W (mm / inch)	155	6.1	165	6.5	178	7	200	7.9	223	8.8	320	12.6	390	15.4	480	18.9	550	21.7	550	21.7	740	29.1	740	29.1	740	29.1
700 Flanged "Y" PN25 Class 300	h (mm / inch)	78	3.1	83	3.3	95	3.7	100	3.9	115	4.5	143	5.6	172	6.8	204	8	242	9.5	268	10.6	300	11.8	319	12.6	358	14.1
	H (mm / inch)	239	9.4	244	9.6	257	10.1	305	12	366	14.4	492	19.4	584	23	724	28.5	840	33.1	866	34.1	1,108	43.6	1,127	44.4	1,167	45.9
	Weight (Kg/lb)	9.1	20	10.6	23	13	29	22	49	37	82	75	165	125	276	217	478	370	816	381	840	846	1,865	945	2,083	962	2,121
	L (mm / inch)	205	8.1	210	8.3	222	8.7	264	10.4	335	13.2	433	17	524	20.6	637	25.1	762	30	767	30.2	1,024	40.3	1,030	40.6	1,136	44.7
700 Threaded Angle PN16; 25 Class 150; 300	W (mm / inch)	155	6.1	165	6.5	185	7.3	207	8.1	250	9.8	320	12.6	390	15.4	480	18.9	550	21.7	570	22.4	740	29.1	740	29.1	750	29.5
	h (mm / inch)	78	3.1	83	3.3	95	3.7	105	4.1	127	5	159	6.3	191	7.5	223	8.8	261	10.3	295	11.6	325	12.8	357	14.1	389	15.3
	H (mm / inch)	239	9.4	244	9.6	257	10.1	314	12.4	378	14.9	508	20	602	23.7	742	29.2	859	33.8	893	35.2	1,133	44.6	1,165	45.9	1,197	47.1
	Weight (Kg/lb)	10	22	12.2	27	15	33	25	55	43	95	85	187	146	322	245	540	410	904	434	957	900	1984	967	2,132	986	2,174
700 Threaded Angle PN16; 25 Class 150; 300	L (mm / inch)	155	6.1	155	6.1	212	8.3	250	9.8	-	-	-	-	-	-	-	-	-	-	-	-	-	-	-	-	-	-
	W (mm / inch)	122	4.8	122	4.8	122	4.8	163	6.4	-	-	-	-	-	-	-	-	-	-	-	-	-	-	-	-	-	-
	h (mm / inch)	40	1.6	40	1.6	48	1.9	56	2.2	-	-	-	-	-	-	-	-	-	-	-	-	-	-	-	-	-	-
	H (mm / inch)	201	7.9	202	8	209	8.2	264	10.4	-	-	-	-	-	-	-	-	-	-	-	-	-	-	-	-	-	-
700 Threaded Globe PN16 Class 150	Weight (Kg/lb)	5.5	12	5.5	12	8	18	17	37	-	-	-	-	-	-	-	-	-	-	-	-	-	-	-	-	-	-
	L (mm / inch)	-	-	121	4.8	140	5.5	159	6.3	-	-	-	-	-	-	-	-	-	-	-	-	-	-	-	-	-	-
	W (mm / inch)	-	-	122	4.8	122	4.8	163	6.4	-	-	-	-	-	-	-	-	-	-	-	-	-	-	-	-	-	-
	R (mm / inch)	-	-	40	1.6	48	1.9	55	2.2	-	-	-	-	-	-	-	-	-	-	-	-	-	-	-	-	-	-
700 Threaded Globe PN25 Class 300	h (mm / inch)	-	-	83	3.3	102	4	115	4.5	-	-	-	-	-	-	-	-	-	-	-	-	-	-	-	-	-	-
	H (mm / inch)	-	-	225	8.9	242	9.5	294	11.6	-	-	-	-	-	-	-	-	-	-	-	-	-	-	-	-	-	-
	Weight (Kg/lb)	-	-	5.5	12	7	15	15	33	-	-	-	-	-	-	-	-	-	-	-	-	-	-	-	-	-	-

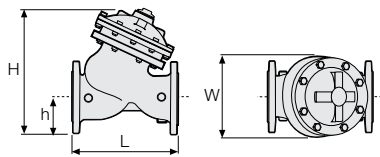

Specify when ordering:

- Size
- Main model
- Additional features
- Pattern
- Body material
- End connection
- Coating
- Voltage & main valve position
- Tubing & Fittings materials
- Operational data (according to model)
- Pressure data
- Flow data
- Reservoir level data
- Settings

* Use Bermad's Waterworks Ordering Guide

