

# BIC-F Modular Backflushing Controller

## BERMAD Irrigation Control System

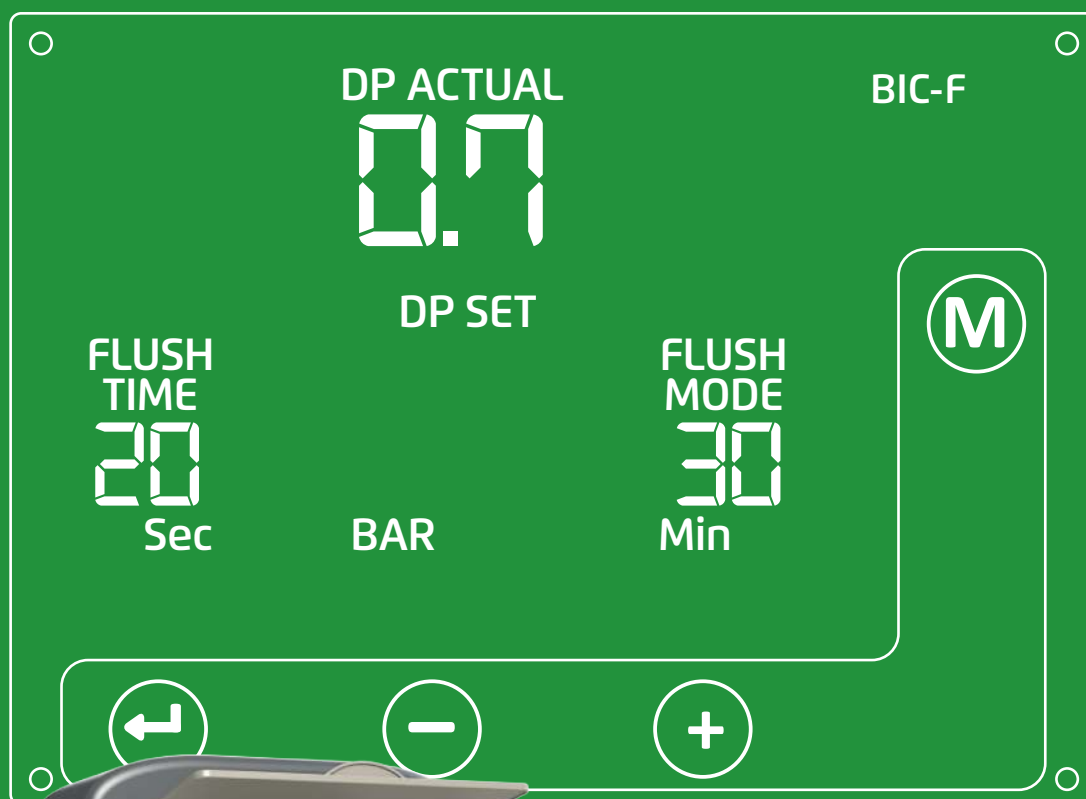

Operation Manual



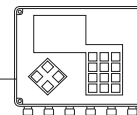

## Contents

Page

1.	Features and Benefits	3
2.	Program the Controller	4
3.	Description of Editable Fields	5
4.	Configuration Process	6
5.	Handling Endless Looping Problems	7
6.	Handling Low Pressure	8
7.	Connecting the DP Sensor to the Filter System	8
8.	Low Battery	8
9.	Manual Activation	8
10.	Timing Diagram	9
11.	Wiring Diagram	10
12.	Technical Data	12

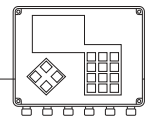

### 1. Features and Benefits

- **Modular back flush controller –**
  - » 1 - 10 filters
- **DC or AC powered –**
  - » DC Model operates 12V DC Latching solenoids
  - » AC model operates 24V AC solenoids
- **Multiple back flush triggers –**
  - » Time
  - » Pressure Differential by embedded DP sensor and time back up
  - » Pressure Differential by external, dry contact DP switch and time back up
- **Continuous back flush loops detection –**
  - » Eliminates continuous cycles of back flush caused by filtration failure
- **Manage Pressure Sustaining or Main Valve –**
  - » Conserve energy by holding back pressure only during flush
  - » Allows full flow when irrigating
  - » Use BERMAD model x30-59
- **Alarm output –**
  - » Alert locally or remote of filter system problems
- **Large LCD display and four buttons keyboard –**
  - » Ease of operation and system monitoring
- **Filter flush counters –**
  - » Monitoring number of flush cycles by time and pressure differential



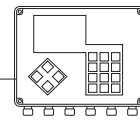

## 2. Program the Controller

The controller is equipped with an LCD display and 4 keys (see image below). When the unit is left untouched for one minute the display switches off and the unit beeps every 20 seconds to indicate that the controller is still operating. Holding down any of the keys for a few seconds reactivates the display.

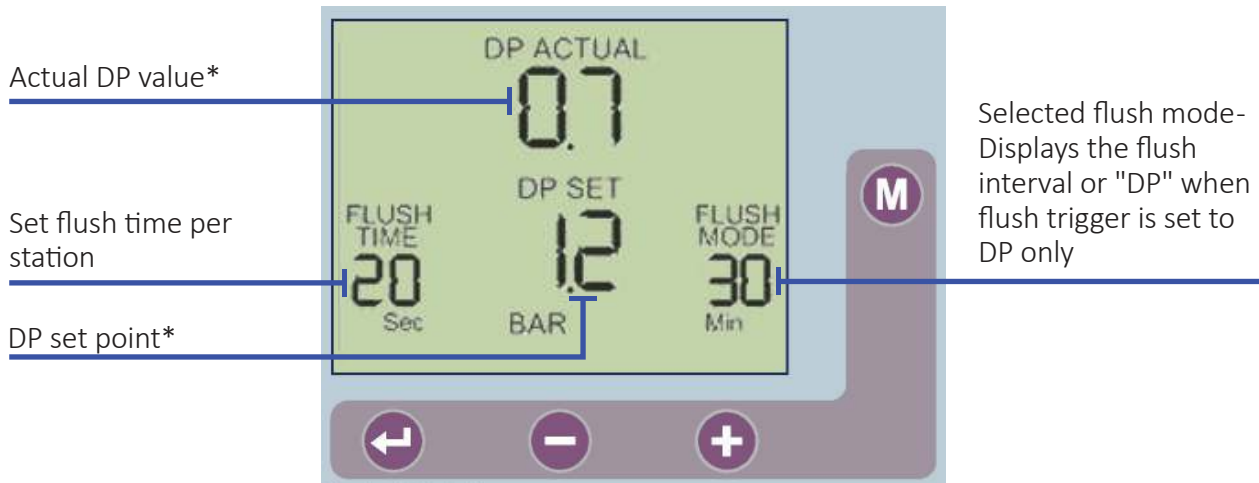

\*Available only when the built-in electronic DP is used.

The screen consists of several fields, some editable and some not.

To change the editable fields:

1. Push the **ENTER** key.

The first editable field blinks and is active.

2. Use the **+** and **-** keys to change the value.
3. Push the **ENTER** key again to set the new value.

The next editable field blinks and is active.

4. Scroll through the fields until all are set as required.
5. To return to the first field, scroll past the last field.

**NOTE:** Before defining the flushing program for the first time, it might be necessary to perform the "Configuration Process" on page 6.

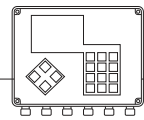

### 3. Description of Editable Fields

This section describes the options for each editable field. The image below illustrates the order in which the fields are activated when scrolling through them with the **ENTER** button.

**NOTE:** The DP SET POINT field is only enabled when the built-in electronic DP is used.

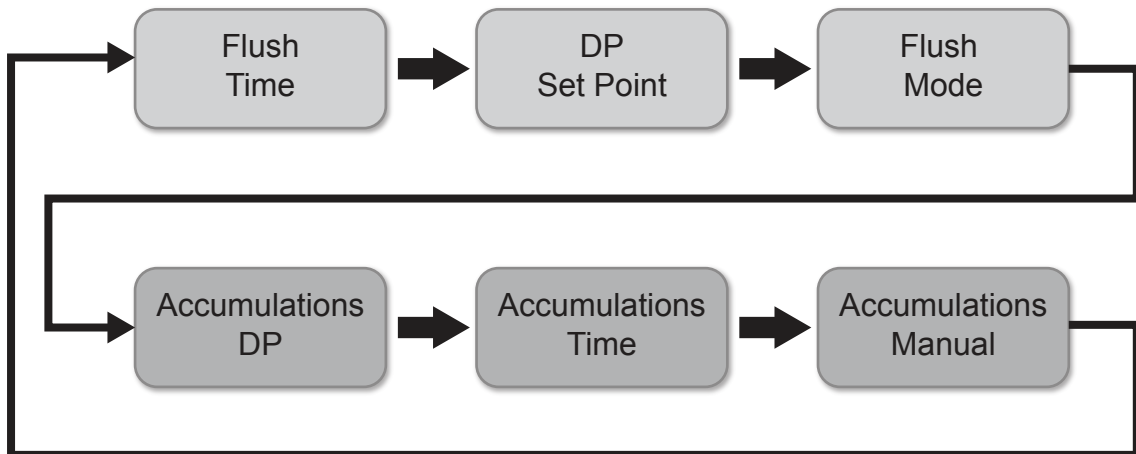

#### Flush Time

Defines the duration of the flushing time per station. Select one of the following options:

- 5-20 seconds in steps of 1 second
- 20-55 seconds in steps of 5 seconds
- 1-6 minutes in steps of 0.5 minute

#### DP Set Point

Defines the pressure difference between the filter's inlet and outlet. When reached, a flushing cycle initiates. This field appears only when the system includes the built in electronic DP sensor.

- When the pressure is expressed in BAR, the range of values is 0.1 - 2.0 BAR.
- When the pressure is expressed in PSI, the range of values is 1- 30 PSI.
- When the system does not include the built in electronic DP sensor but uses, instead, an external DP sensor, the flushing request signal arrives in the form of a closed dry contact.

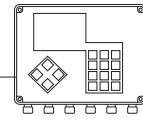

### Flush Mode

Defines how the flushing cycles are triggered. Select one of the following options:

- **OFF** – no flushing occurs.
- **Time** – flushing cycles are repeated in a defined interval or are triggered by the DP signal - whichever happens first. No matter how the flushing cycle started, the interval to the next cycle starts counting down at the end of the current flushing cycle. Select one of the following time intervals:
  - » 5, 10, 15, 20, 25, 30, 35, 40, 45, 50, 55, 60 minutes
  - » 2, 3, 4, 5, 6, 8, 12, 18, 24, 72, 120 hours
- **DP** – flushing is triggered by DP only.

**NOTE:** When in Flush Mode, press and hold the **+** and **-** keys to display the time remaining until the next cycle - alternately hours and minutes.

### Accumulations

- The unit accumulates and displays the number of flushing cycles initiated by DP, by time, or by manual activation.
- At each of the accumulation fields, the **+** or **-** keys can be used to change the accumulation value.

## 4. Configuration Process

To begin the configuration process, press and hold the **ENTER** key for 3 seconds.

The unit detects how many plug-in boards (each with 2 outputs) are used in the system.

### Configuration Process Definitions

During the configuration process the following features are defined:

- **Main Valve (sustaining valve) – Yes/ No.** When the answer is **Yes** the Pre Dwell delay between the Main Valve opening and the Station No. 1 opening can be defined. The selectable delay steps are:
  - » 5, 10, 15, 20, 25, 30, 35, 40, 45, 50, 55 sec
  - » 1, 1.5, 2, 2.5, 3, 3.5, 4, 4.5, 5, 5.5, 6 min
- **Dwell time** – the delay between stations; can be set to 5, 10, 15, 20, 25, 30, 35, 40, 45, 50, 55, or 60 sec.
- **DP delay** – the delay during which the DP sensor reading is expected to remain stable before reaction; 5, 10, 15, 20, 25, 30, 35, 40, 45, 50, 55, 60 sec.
- **Looping limit** – the number of consecutive flushing cycles triggered by the DP sensor before an endless looping problem is indicated. The options are: 1-10 or select **no** to ignore the looping problem.
- **Alarm - Yes/No** – allocating one output for alarm activation.
- **Delay Valve – Yes/No;** allocating an output for Delay Valve activation.
- **View Outputs** – a special mode that enables scrolling through all outputs to see how each output was allocated. Use the **+** key to alternate between **no** and **yes** and confirm by pressing the **-** key. Continue to press the **+** key to scroll through the list. At the bottom left corner the ordinal number of the output is displayed and

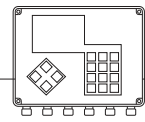

its allocated function appears in large letters in the center of the screen. Notice that the number of possible outputs that can be used is always an even number since it results from the number of plug-in boards included (each board with 2 outputs) . However, if the number of required outputs is not an even number, then the last valve allocated for flushing can be canceled by using the **M** (manual operations) key.

- **Pressure units** – define the units to be used for pressure measurement. Select between **BAR** or **PSI** .
- **Calibration** – Zero calibration of the built-in electronic DP sensor. While the sensor ports are disconnected select Calibration = **Yes**.

## 5. Handling Endless Looping Problems

As explained above, an endless looping problem is identified when the number of consecutive flushing cycles triggered by the DP sensor exceeds the **Looping Limit** defined during configuration. After detection of an endless looping problem, the DP indication no longer triggers a flushing cycle and subsequent flushing cycles are triggered by the interval countdown only.

The endless looping problem is considered resolved when the constant indication of the DP sensor stops.

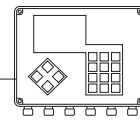

## 6. Handling Low Pressure

When a closed contact indication is received at the low pressure input of the controller, the low pressure icon  appears blinking on the display. All activities stop, including the countdown to the next flushing cycle. If the low pressure occurred while a flushing cycle was in progress, when the low pressure condition ends, the flushing cycle starts from the beginning rather than continuing from the stopping point.

## 7. Connecting the DP Sensor to the Filter System

The DP sensor is connected to the filter system by 2 command tubes, the one that comes from the filter inlet (high pressure) is connected to the red fitting, and the one that comes from the outlet (lower pressure) is connected to the black fitting.

**IMPORTANT:** A small 120 mesh filter must be installed between the red fitting and the high pressure connection point (see image below). **This filter is not supplied by Bermad and must be provided by the user.**

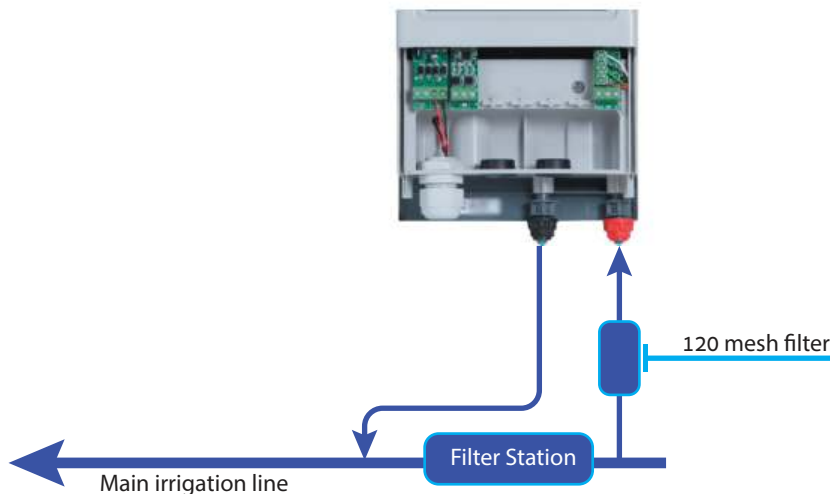

## 8. Low Battery

The unit has two levels of low battery indication. When the battery voltage drops to the first level, the low battery icon  appears on the screen. When the battery voltage drops further and reaches the second level, all outputs shut down and the screen clears leaving only the low battery icon.

## 9. Manual Activation

A flushing sequence can be manually activated by pressing the  key. When manually activated, the manual operation icon  appears on the display. Press the  key again to terminate a sequence in progress.



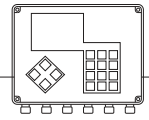

### 10. Timing Diagram

Without Delay Valve

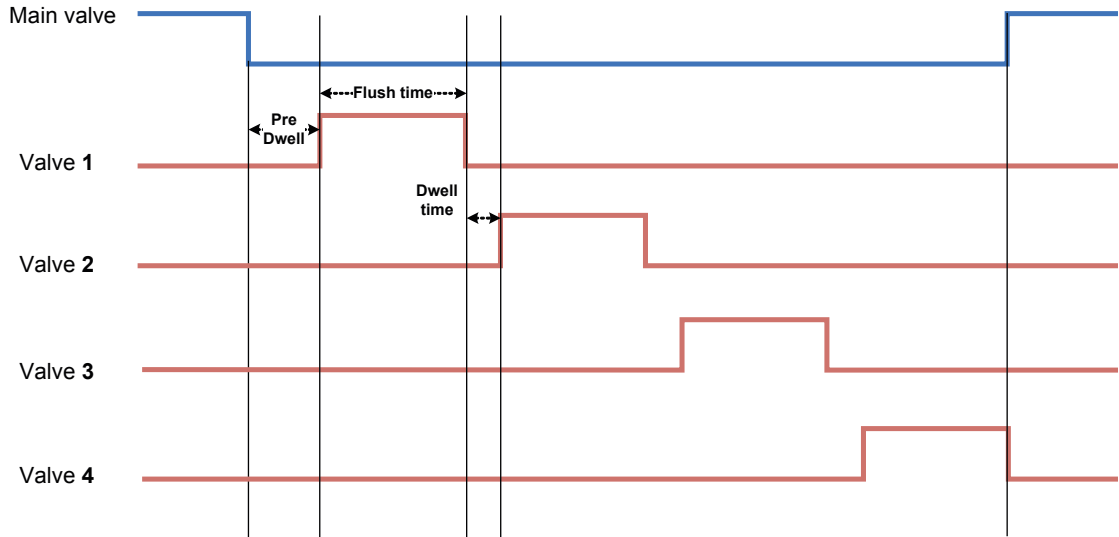

Including Delay Valve

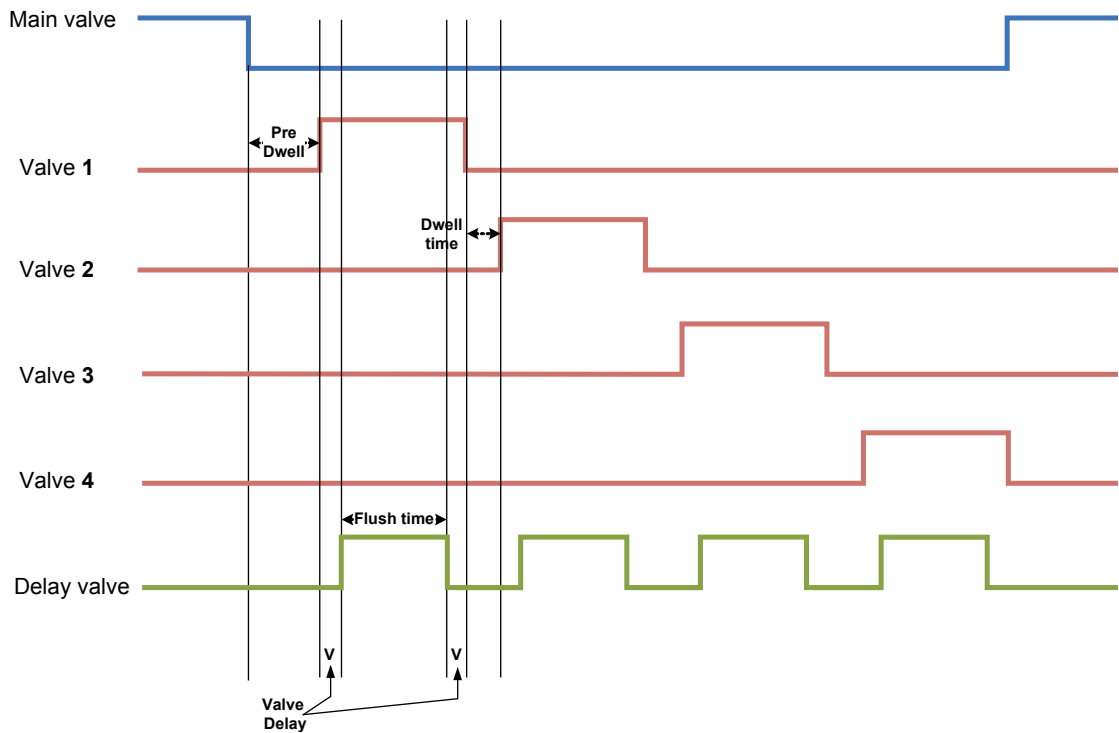

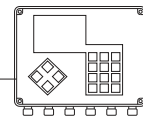

### 11. Wiring Diagram

#### DC MODEL

The image below shows the wiring of the DC model controller.

**Notice that:**

- The external DP sensor is optional and it is intended for use when there is no Embedded Electronic DP included.
- The unit can be powered either by 6V DC or 12V DC.
- The solenoids are 12VDC latch.

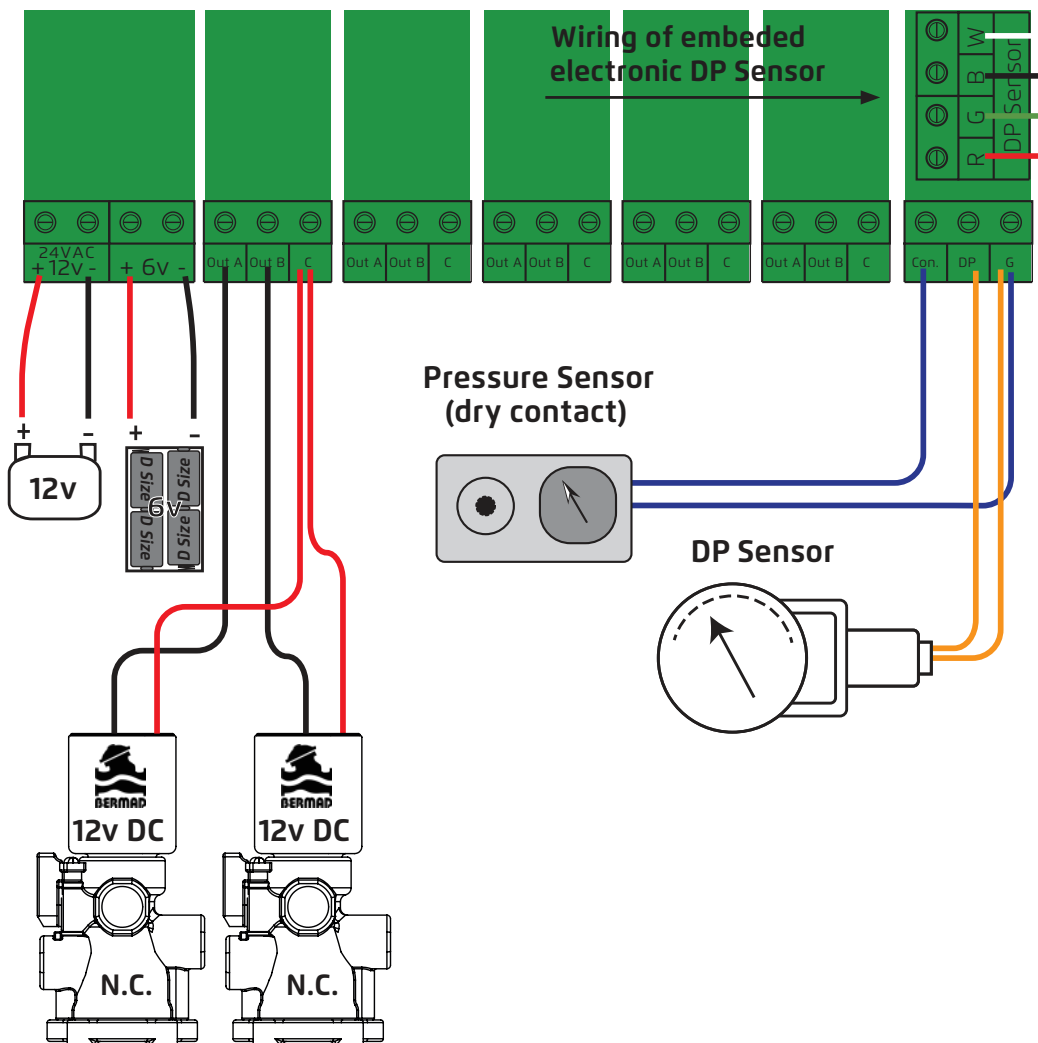

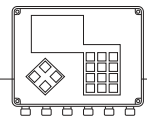

### AC MODEL

The drawing below shows the wiring of the AC model controller.

**Notice that:**

- The External DP sensor is optional and it is intended for use when there is no Embedded Electronic DP included.
- The unit is powered by 24VAC transformed from 220/110 VAC.
- The solenoids are 24VAC.

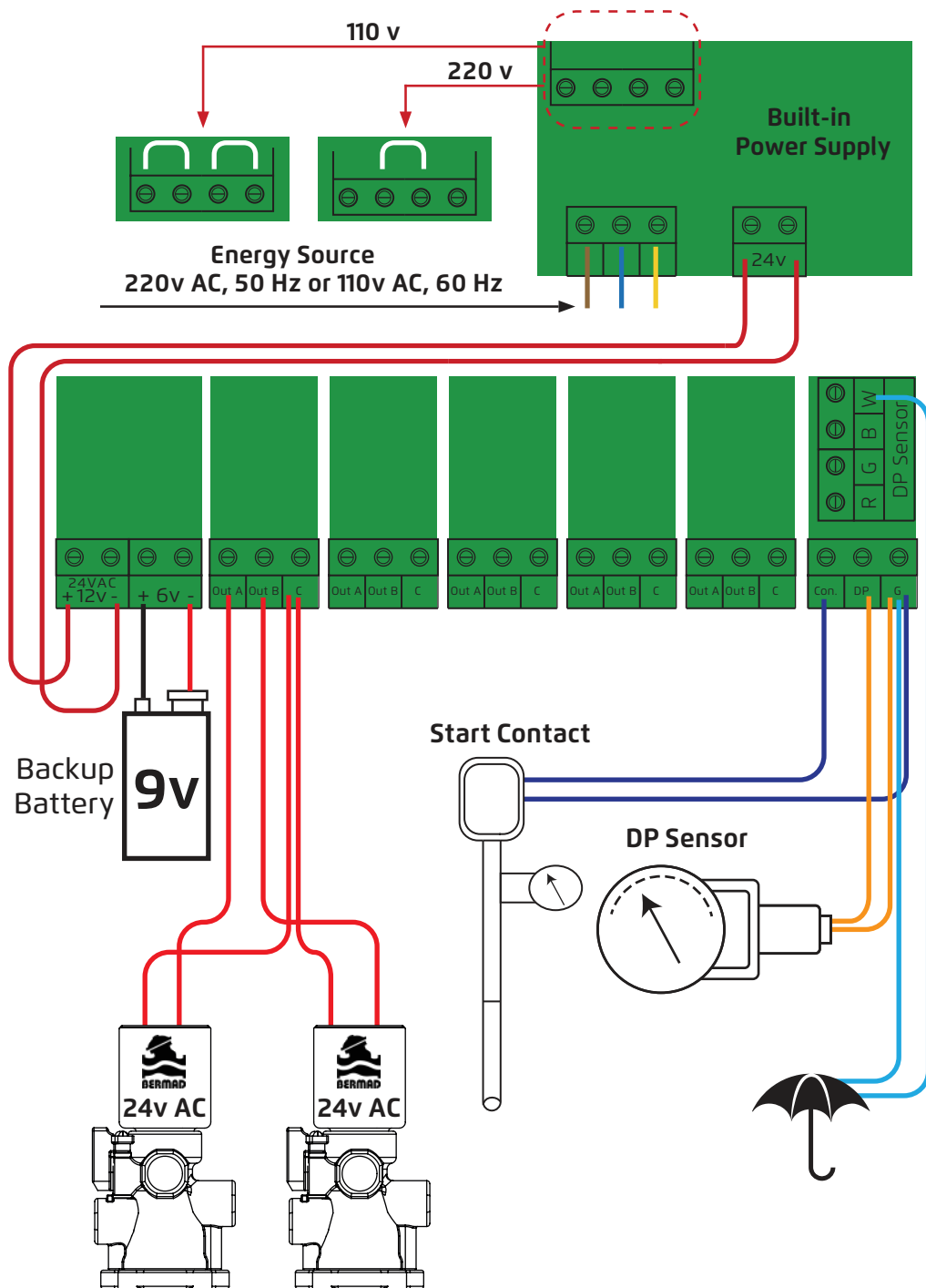

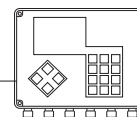

## 12. TECHNICAL DATA

### DC MODEL

- Power source - one of the following:
  - » 6V supplied by 4 x 1.5 "D" size alkaline batteries
  - » 12V DC dry battery
  - » 12V rechargeable battery with solar panel of 2 watts
- Outputs : 12V DC latching solenoids
- DP - one of the following:
  - » Embedded electronic analog DP sensor
  - » External dry contact DP sensor
- Pressure sensor: Dry contact pressure sensor
- Operating temperature: 0-60° C

### AC MODEL

- Power source: 220V or 110V AC 50 or 60 Hz with built in transformer to 24V AC.
- Outputs: 24V AC solenoids.
- DP - one of the following:
  - » Embedded electronic analog DP sensor
  - » External dry contact DP sensor
- Pressure sensor: Dry contact pressure sensor
- Operating temperature: 0-60° C.

# BERMAD Water Control Solutions

---



[info@bermad.com](mailto:info@bermad.com) • [www.bermad.com](http://www.bermad.com)

© Copyright 2007-2012 Bermad CS Ltd. All Rights Reserved. The information contained in this document is subject to change without notice. BERMAD shall not be liable for any errors contained herein.

May 2016