

Hydraulically Controlled Pressure Deluge Valve with Local Reset

Model FP 400Y - 1MC

The BERMAD model 400Y-1MC is an elastomeric, hydraulic, line pressure operated deluge valve, designed specifically for advanced fire protection systems and the latest industry standards.

The 400Y-1MC is activated by a hydraulic relay valve which latches the deluge valve open until reset locally.

An integral pressure reducing pilot valve ensures a precise, preset and stable downstream system water pressure.

The optional valve position indicator can include a limit switch suitable for Fire & Gas monitoring systems.

The 400Y-1MC is ideal for systems with open nozzles with a high pressure water supply for water or foam discharge.



(for Illustration Only)

Benefits and Features

■ Safety and reliability

- Time proven, simple, fail-safe actuation
- Single piece, rugged elastomeric diaphragm seal - VRSD technology
- Obstacle-free, uninterrupted flow path
- No mechanical moving parts
- Latches open: remains open until reset locally
- Valve position limit switches (optional)

■ High performance

- Very high flow efficiency
- Straight through flow Y- type body
- Approved for PN25 / 365 psi

■ Designed for fire protection

- Face-to-face length standardized to ISO 5752 / EN558-1
- Meets the requirements of the industry standards

■ Quick and easy maintenance

- In-line serviceable
- Fast and easy cover removal
- Swivel mounted drain valves*

* not including 1½" & 2" valves

Typical Applications

- High Pressure water supply
- Automatic water spray
- Foam applications
- Corrosive water systems

Approvals



UL-Listed
Special System Water Control
Valves, Deluge Type (VLFT)
Sizes 3" - 10"



Det Norske Veritas
Type Approval



ABS
American Bureau of Shipping
Type Approval



Lloyd's Register
Type Approval

Additional Features

- Valve position limit switches
- Water motor alarm
- Sea water compatibility
- Drain valve/s inlet/outlet
- Alarm pressure switch
- Adjustable water column offset feature

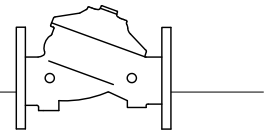

Operation

(for Illustration Only)

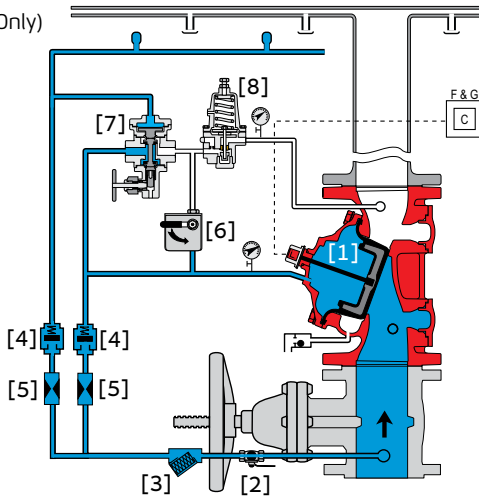

Valve Closed (normal conditions)

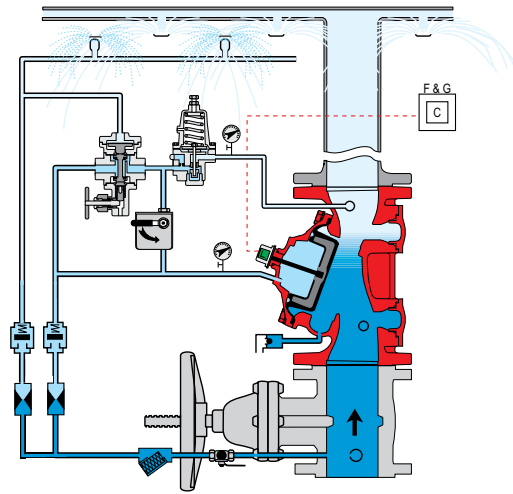

Valve Open (fire conditions)

The BERMAD model 400Y-1MC is held closed by water pressure in the control chamber [1]. Upon release of pressure from the control chamber, the valve opens.

Under NORMAL conditions, water pressure is supplied to the control chamber via the priming line [2] and strainer [3] and is then trapped in the control chamber by a check valve [4], restriction orifice [5], manual emergency release [6] and a latching relay valve (URV - M) [7], that is held closed by water pressure supplied by the pilot line.

The water pressure trapped in the control chamber of the deluge valve holds the diaphragm against the valve seat sealing it drip-tight and keeping the system pipes dry.

Under FIRE conditions, water pressure is released from the control chamber, either with the manual emergency release, or by the URV switching to the release position in response to a drop in pressure in the pilot line caused by one or more of the fusible plugs opening. This latches the 400Y 1MC deluge valve open, allowing water to flow into the system.

The pressure-reducing pilot valve [8] senses changes in outlet pressure and modulates the main valve to maintain the set downstream pressure. When outlet pressure changes, the pressure-reducing pilot opens or closes in response. This regulates the pressure in the main valve's control chamber, thus modulating the position of the diaphragm seal disk to maintain the set downstream pressure.

System P&ID

Remote Release / Wet Pilot Line

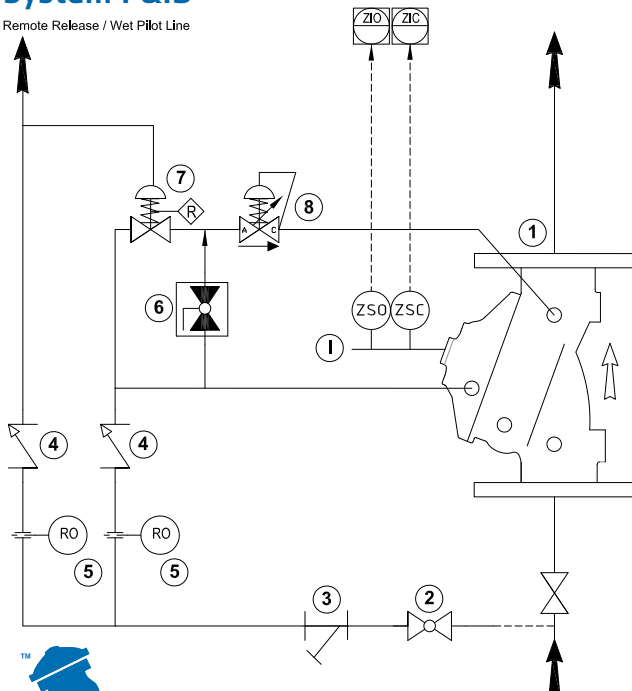

Components

- 1 BERMAD 400Y Deluge Valve
- 2 Priming Ball Valve
- 3 Priming Strainer
- 4 Check Valve
- 5 Restriction Orifice
- 6 Manual Emergency Release
- 7 URV-2-M Relay Valve
- 8 Pressure Reducing Pilot

Optional System Items

- ZS Limit Switch Assembly
- I Visual Indicator

See also Factory Fitted Options under the Valve Code Designations on the last page



System Installation

A typical installation of the BERMAD model 400Y-1MC features automatic actuation via a hydraulic universal relay valve, triggered by a fusible plug loop. A pressure reducing pilot valve integrated in the trim ensures a precise and stable pre-set downstream pressure. When fitted with a limit switch the valve can send a feedback signal to a remote valve position monitoring system.

Optional System Items

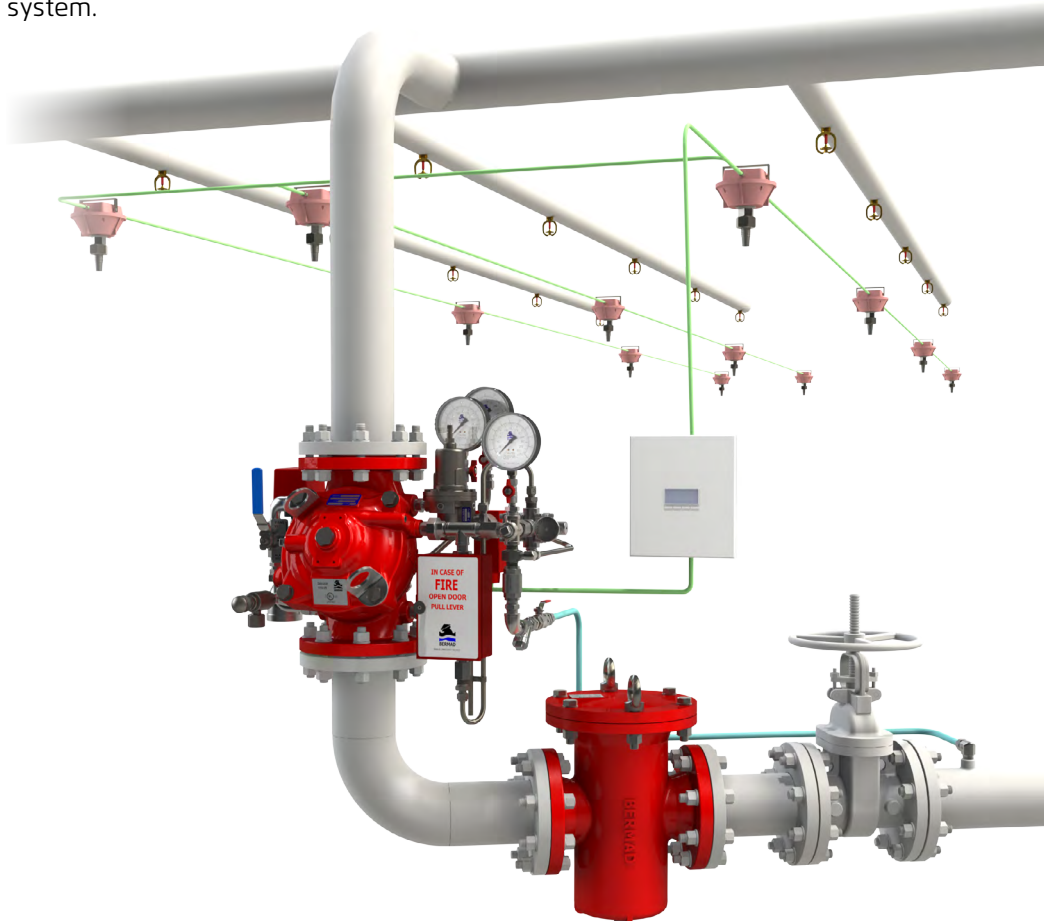
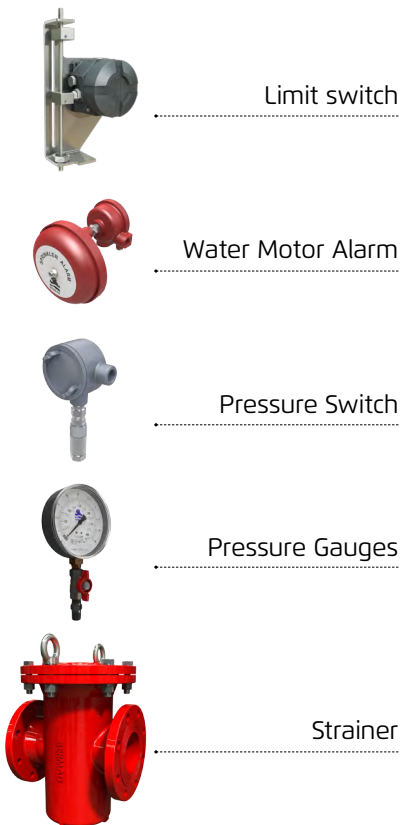

(for Illustration Only)

Engineering Specifications

The deluge valve shall be a UL-listed, 25-bar/365-psi rated, elastomeric type, with a straight-through Y-type-body. The valve shall have an unobstructed flow path, with no stem guide or supporting ribs.

Valve actuation shall be accomplished by a single-piece rolling diaphragm, bonded with a rugged radial seal disk. The diaphragm assembly shall be the only moving part.

The deluge valve shall include a relay pilot valve, a Y-type strainer, a ball drain valve, an automatic drip-check with manual override, 4-inch pressure gauges, and a manual emergency release housed in a stainless steel box.

The valve drain socket shall be flanged and have 360-degree swivel. The valve shall be equipped with two limit switches.

Removing the valve cover for inspection or maintenance shall be in line and not require removal of the control trim.

The deluge valve and its entire control trim shall be supplied pre-assembled and hydraulically tested by a factory certified to ISO 9000 and 9001 standards.

BERMAD Fire Protection

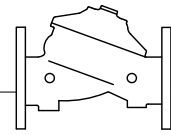

Model FP 400Y - 1MC

400Y Series

Technical Data

Available Sizes (inch)

- Flanged - 1½, 2, 3, 4, 6, 8, 10, 12, 14 & 16"
- Grooved - 1½, 2, 3, 4, 6 & 8"
- Threaded - 1½ & 2"

Pressure Rating

- ANSI#150 - 16 bar / 235 psi
- ANSI#300 - 1½" to 10" 25 bar / 365 psi
12" to 16" 20 bar / 300 psi
- Grooved/Threaded - 25 bar / 365 psi
- Setting range: 4 - 12 bar (60 - 175 psi)

Elastomer

- HTNR - Fabric Reinforced High Temperature Compound - See engineering data

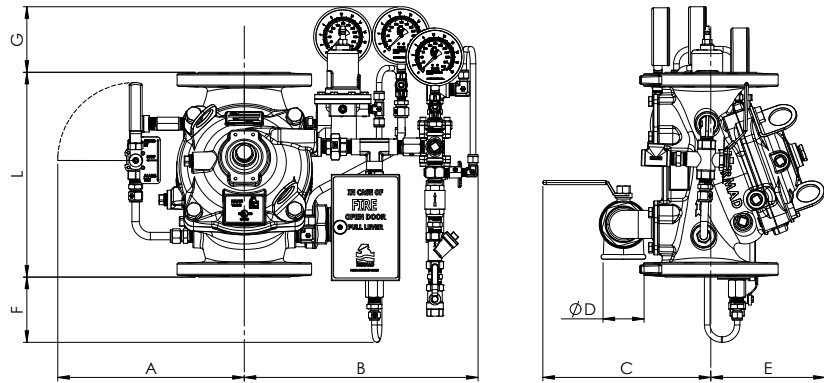

Size	1½" DN40		2" DN50		3" DN80		4" DN100		6" DN150		8" DN200		10" DN250		12" DN300		14" DN350		16" DN400	
Unit	mm	in	mm	in	mm	in	mm	in	mm	in	mm	in	mm	in	mm	in	mm	in	mm	in
L ⁽¹⁾	230	9.1	230	9.1	310	12.2	350	13.8	480	18.9	600	23.6	730	28.7	850	33.5	980	38.6	1100	43.3
L ⁽²⁾	230	9.1	238	9.4	326	12.8	368	14.5	506	19.9	626	24.7	730	28.8	888	35	980	38.6	1100	43.3
A	279	11.0	279	11.0	339	13.3	347	13.7	400	15.7	430	16.9	430	16.9	543	21.4	543	21.4	543	21.4
B	304	12.0	304	12.0	362	14.3	444	17.5	427	16.8	455	17.9	455	17.9	568	22.4	568	22.4	568	22.4
C	241	9.5	241	9.5	274	10.8	290	11.4	304.5	12.0	320	12.6	320	12.6	383	15.1	383	15.1	408	16.1
ØD	¾"		¾"		1½"		2"		2"		2"		2"		2"		2"		2"	
E	120	4.7	120	4.7	146	5.7	158	6.2	228	9.0	295	11.6	295	11.6	441	17.4	441	17.4	415	16.3
F	204	8.0	204	8.0	134	5.3	107	4.2	25.5	1.0	-	-	-	-	-	-	-	-	-	-
G	116	4.6	116	4.6	106	4.2	93	3.7	44.5	1.8	-	-	-	-	-	-	-	-	-	-
Kv / Cv	68 / 79		80 / 92		190 / 219		345 / 398		790 / 912		1160 / 1340		1355 / 1565		2370 / 2737		2850 / 3292		3254 / 3758	
Leq ⁽³⁾ : m / ft	2 / 7		5 / 16		7 / 23		9 / 30		15 / 49		27 / 89		62 / 203		52 / 171		59 / 194		88 / 289	
Kg/lb (flanged#150/ISO16)	25.9 / 57		27.3 / 60.1		42 / 92.4		52 / 114		95.3 / 210		159 / 349		189 / 415		332 / 729		365 / 802		411 / 903	

Notes: ⁽¹⁾ Refers to the length dimensions for Raised Face ANSI #150, ISO 16 Flanged, Threaded and Grooved valves

⁽²⁾ Refers to the length dimensions for Raised Face ANSI #300 and ISO 25 Flanged valves

⁽³⁾ Leq (Equivalent Pipe Length) refers to a fully opened valve with turbulent flow in new steel pipe schedule 40, values given for general consideration only

⁽⁴⁾ Dimensions for the trim envelope may vary with specific component positioning

⁽⁵⁾ Kv and Cv values given for a fully opened valve.

Valve Code Designations

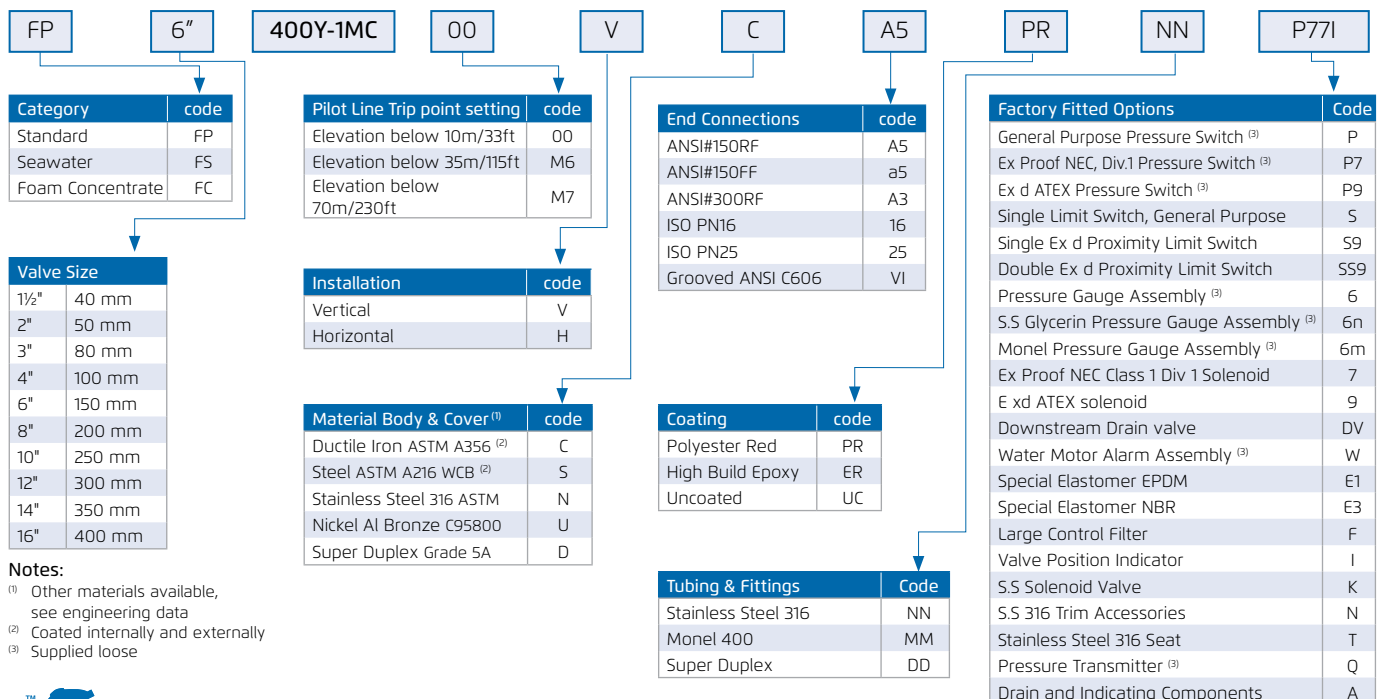

Notes:

⁽¹⁾ Other materials available, see engineering data

⁽²⁾ Coated internally and externally

⁽³⁾ Supplied loose



www.bermad.com

© Copyright 2007-2012 Bermad CS Ltd. All Rights Reserved. The information contained in this document is subject to change without notice. BERMAD shall not be liable for any errors contained herein. June 2017