

Pneumatically Controlled On-Off Deluge Valve

Model FP 400Y - 4D

The BERMAD model 400Y-4D is an elastomeric, hydraulic line operated deluge valve, designed specifically for advanced fire protection systems and the latest industry standards.

The 400Y-4D is controlled by a pneumatic relay valve, typically activated by a decrease in pressure of a pneumatic pilot line. The 400Y-4D can also be operated remotely.

The optional valve position indicator can include a limit switch suitable for Fire & Gas monitoring systems.

The Bermad 400Y 4D is ideal for use in systems with open nozzles for water or foam discharge also well suited for use with corrosive media or where freezing temperatures might be experienced.

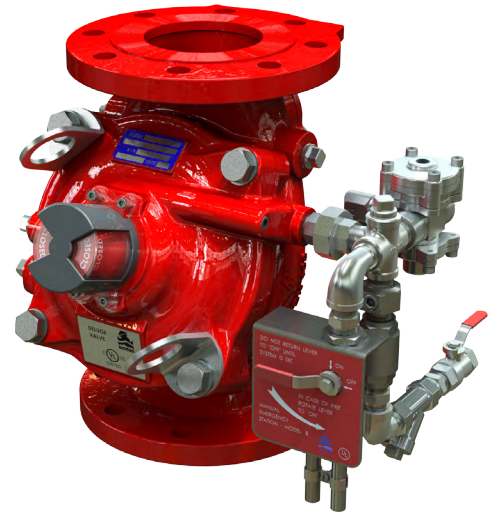

(for Illustration Only)

Benefits and Features

■ Safety and reliability

- ▢ Time proven, Simple, fail-safe actuation
- ▢ Single -piece, rugged, elastomeric diaphragm seal – VRSD technology
- ▢ Obstacle-free, uninterrupted flow path
- ▢ No mechanical moving parts
- ▢ Shuts off on remote command
- ▢ Valve position limit switches (optional)
- ▢ Local valve position indicator beacon (optional)

■ High performance

- ▢ Very high flow efficiency
- ▢ Straight-through-flow Y-type body
- ▢ Approved for PN25 / 365 psi

■ Designed for fire protection

- ▢ Face-to-face length standardized to ISO 5752, EN 588-1
- ▢ Suitable for corrosive fluids and freezing temperatures
- ▢ Meets the requirements of the industry standards

■ Quick and easy maintenance

- ▢ In-line serviceable
- ▢ Fast and easy cover removal
- ▢ Swivel mounted drain valves*

* not including 1½" & 2" valves

Typical Applications

- Remote control water spray systems
- Foam applications
- Corrosive water supplies
- Freezing Environments

Approvals



UL-Listed
Special System Water Control
Valves, Deluge Type (VLFT)
Sizes 3" - 10"



Det Norske Veritas
Type Approval



ABS
American Bureau of Shipping
Type Approval



Lloyd's Register
Type Approval

Additional Options

- Valve position limit switches
- Local valve position indicator beacon
- Sea water compatibility
- Alarm pressure switch
- Drain valve/s inlet/outlet
- Air maintenance device
- For "automatic activation" select BERMAD local or remote reset model

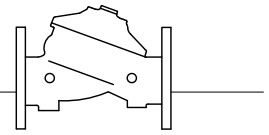

Operation

(for Illustration Only)

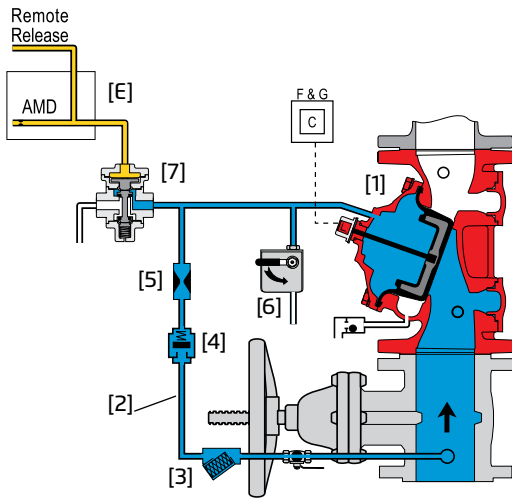

Valve Closed (normal conditions)

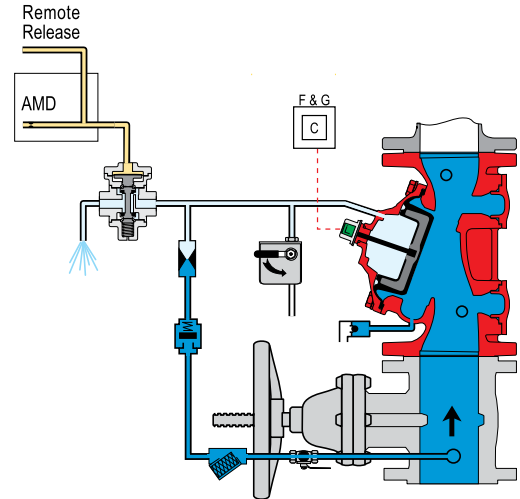

Valve Open (fire conditions)

The BERMAD model 400Y-4D is held closed by water pressure in the control chamber [1]. Upon release of pressure from the control chamber, the valve opens.

Under NORMAL conditions, water pressure is supplied to the control chamber via the priming line [2] strainer [3] and restriction orifice [5], it is then trapped in the control chamber by a check valve [4], manual emergency release [6], and a relay valve (URV) [7] that is held closed by pneumatic pressure in the dry pilot line [E]. The water pressure trapped in the control chamber holds the diaphragm against the valve seat, sealing it drip-tight and keeping the system pipes dry.

Under FIRE conditions, water pressure is released from the control chamber, either with the manual emergency release, or by the URV opening in response to a decrease in pneumatic pilot-line pressure. This opens the 400Y-4D deluge valve, allowing water to flow into the system.

System P&ID

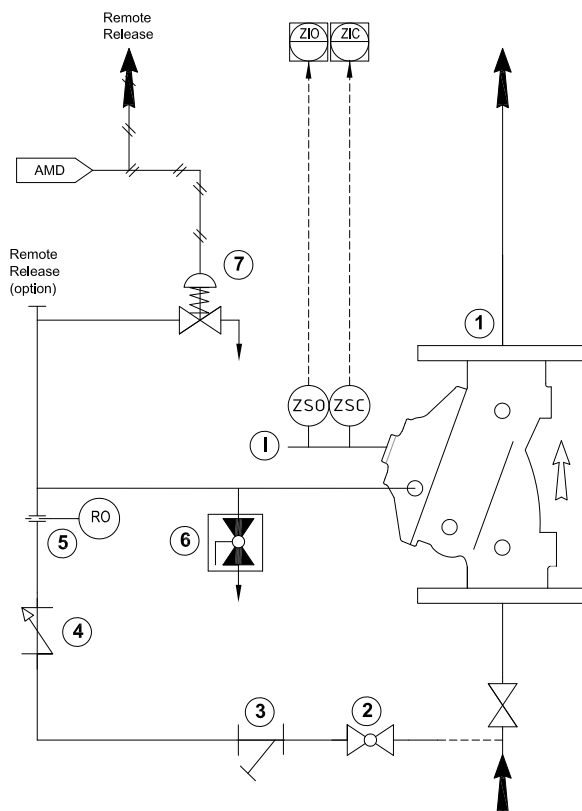

Components

- 1 BERMAD 400Y Deluge Valve
- 2 Priming Ball Valve
- 3 Priming Strainer
- 4 Check Valve
- 5 Restriction Orifice
- 6 Manual Emergency Release
- 7 URV-2 Relay Valve

Optional System Items

- ZS Limit Switch Assembly
- I Visual Indicator
- AMD Air Maintenance Device

See also Factory Fitted Options under the Valve Code Designations on the last page



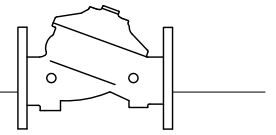

System Installation

A typical installation of the BERMAD model 400Y-4D features actuation via a pneumatic universal relay valve. When open and fitted with a limit switch the valve can send a feedback signal to a remote valve status monitoring system.

Optional System Items

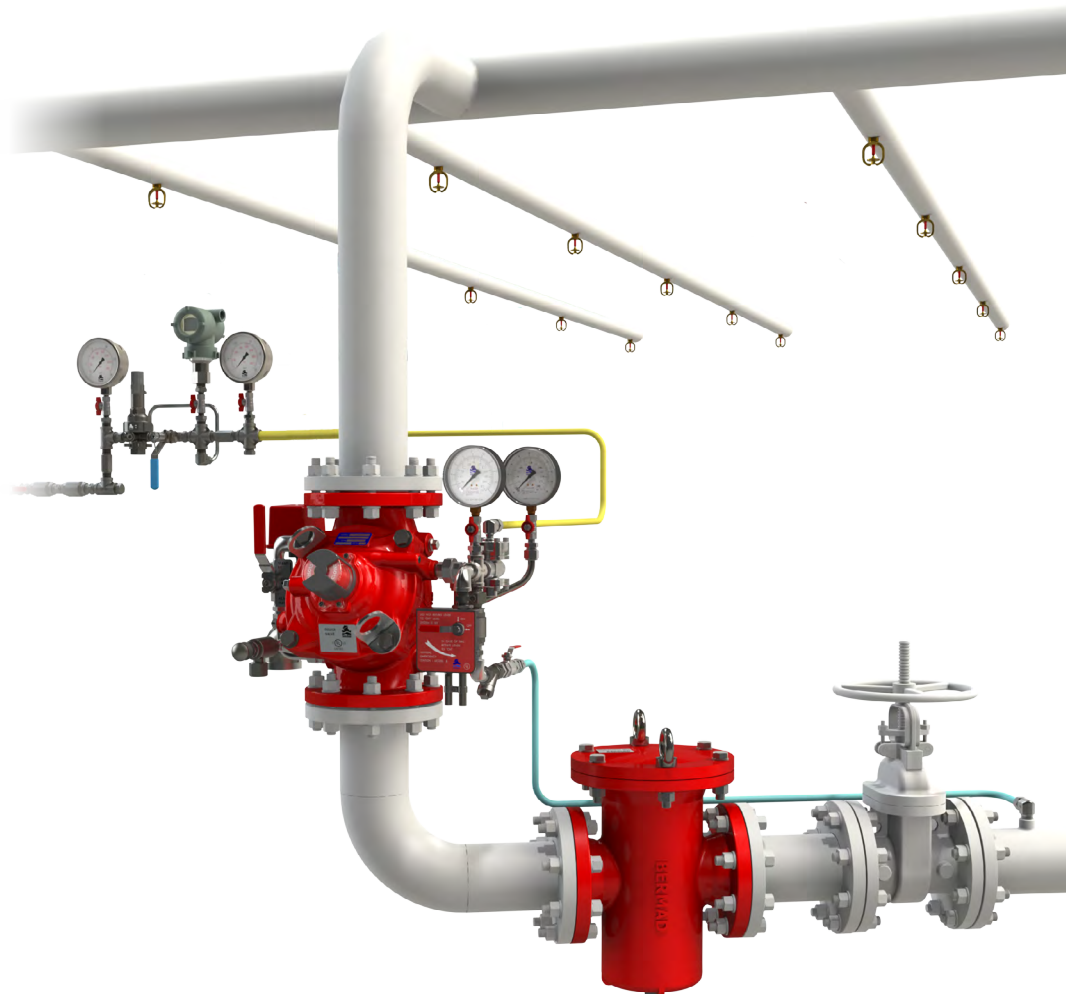
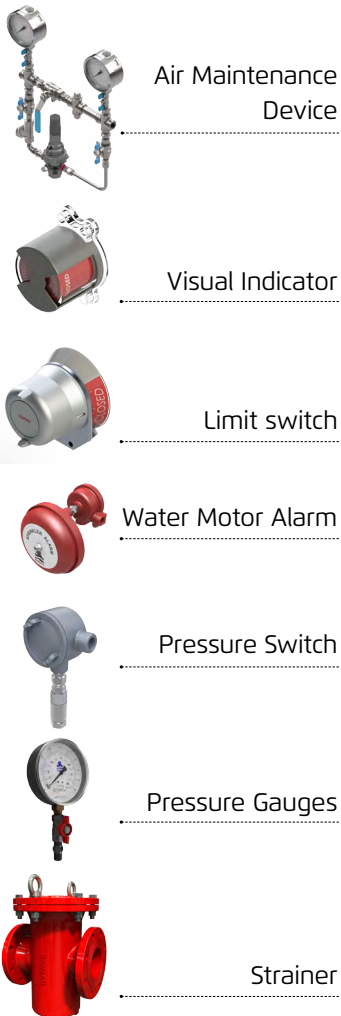

(for Illustration Only)

Suggested Specifications

The deluge valve shall be UL-listed, 25 bar / 365 psi rated, elastomeric type with a straight-through, Y-type-body. The valve shall have an unobstructed flow path, with no stem guide or supporting ribs.

Valve actuation shall be accomplished by a single-piece, rolling diaphragm bonded with a rugged radial seal disk. The diaphragm assembly shall be the only moving part. The deluge valve shall include a relay pilot valve, a Y-type strainer, a ball drain valve, an automatic drip-check with manual override, 4-inch pressure gauges, and a manual emergency release housed in a stainless steel box. The valve drain socket shall be flanged and have 360 degree swivel.

The valve shall be equipped with a protective-covered, dual-color, rotational position indicator, readable from 50 meters, and with two limit switches enclosed in a protective switch box.

Removing the valve cover for inspection and maintenance shall be in-line, and not require removal of the control trim.

The deluge valve and its entire control trim shall be supplied pre-assembled and hydraulically tested by a factory certified to ISO 9000 and 9001 standards.

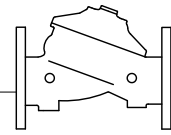

Technical Data

Available Sizes (inch)

- Flanged - 1½, 2, 3, 4, 6, 8, 10, 12, 14 & 16"
- Grooved - 1½, 2, 3, 4, 6 & 8"
- Threaded - 1½ & 2"

Pressure Rating

- ANSI#150 - 16 bar / 235 psi
- ANSI#300 - 1½" to 10" 25 bar / 365 psi
12" to 16" 20 bar / 300 psi
- Grooved - 25 bar / 365 psi
- Threaded - 25 bar / 365 psi

Elastomer

- HTNR - Fabric Reinforced High Temperature Compound - See engineering data

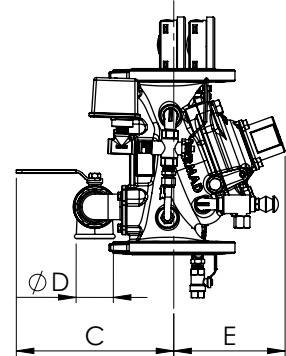
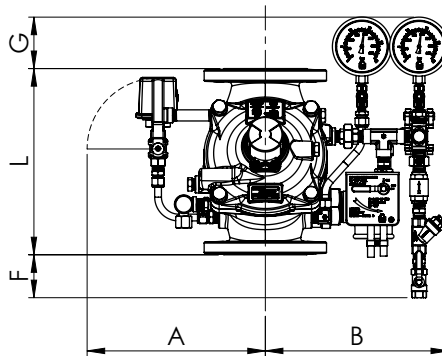

Valve Size	1½" DN40	2" DN50	3" DN80	4" DN100	6" DN150	8" DN200	10" N250	12" DN300	14" DN350	16" DN400
⁽¹⁾ L ANSI #150 mm (in.)	230(9.06)	230(9.06)	310(12.21)	350(13.79)	480(18.91)	600(23.64)	730(28.76)	850(33.49)	980(38.61)	1100(43.34)
L ² ANSI #300 mm (in.)	230(9.06)	238(9.37)	326(12.84)	368(14.50)	506(19.94)	626(24.66)	730(28.76)	888(34.96)	980(38.61)	1100(43.34)
A mm (in.)	330(13.0)	330(13.0)	390(15.4)	398(15.7)	451(17.8)	481(18.9)	481(18.9)	594(23.4)	594(23.4)	594(23.4)
B mm (in.)	279(11)	279(11)	337(13.3)	347(13.7)	402(15.8)	430(16.9)	430(16.9)	543(21.4)	543(21.4)	543(21.4)
C mm (in.)	241(9.5)	241(9.5)	274(10.8)	290(11.4)	304(12.0)	320(12.6)	320(12.6)	383(15.1)	383(15.1)	408(16.1)
ØD	¾"	¾"	1½"	2"	2"	2"	2"	2"	2"	2"
E mm (in.)	167(6.6)	167(6.6)	191(7.5)	205(8.1)	273(10.7)	338(13.3)	338(13.3)	490(19.3)	490(19.3)	465(18.3)
F mm (in.)	179(7)	179(7)	109(4.3)	82(3.2)	0.5(0.01)	-	-	-	-	-
G mm (in.)	116(4.5)	116(4.5)	106(4.2)	93(3.7)	44.5(1.8)	20(0.8)	-	-	-	-
KV m ³ /h (Cv gpm)	68(79)	80(92)	190(219)	345(398)	790(912)	1160(1340)	1355(1565)	2370(2737)	2850(3292)	3254(3758)
⁽²⁾ Leq m (ft)	2(7)	5(16)	7(23)	9(30)	15(49)	27(89)	62(203)	52(171)	59(194)	88(289)
Weight, flanged kg (lbs)	15.1(33.2)	16.2(35.6)	29.9(65.8)	39.9(87.8)	84.2(185.2)	147.4(324.2)	177.4(390.3)	320.5(704.5)	353.3(776.6)	399.3(878.5)

Notes: ⁽¹⁾ L1 Dimensions are for grooved, threaded and raised face flanged valves

⁽²⁾ Leq (Equivalent Pipe Length) refers to turbulent flow in new steel pipe schedule 40, values given for general consideration only

⁽³⁾ Dimensions for the trim envelope may vary with specific component positioning

Valve Code Designations

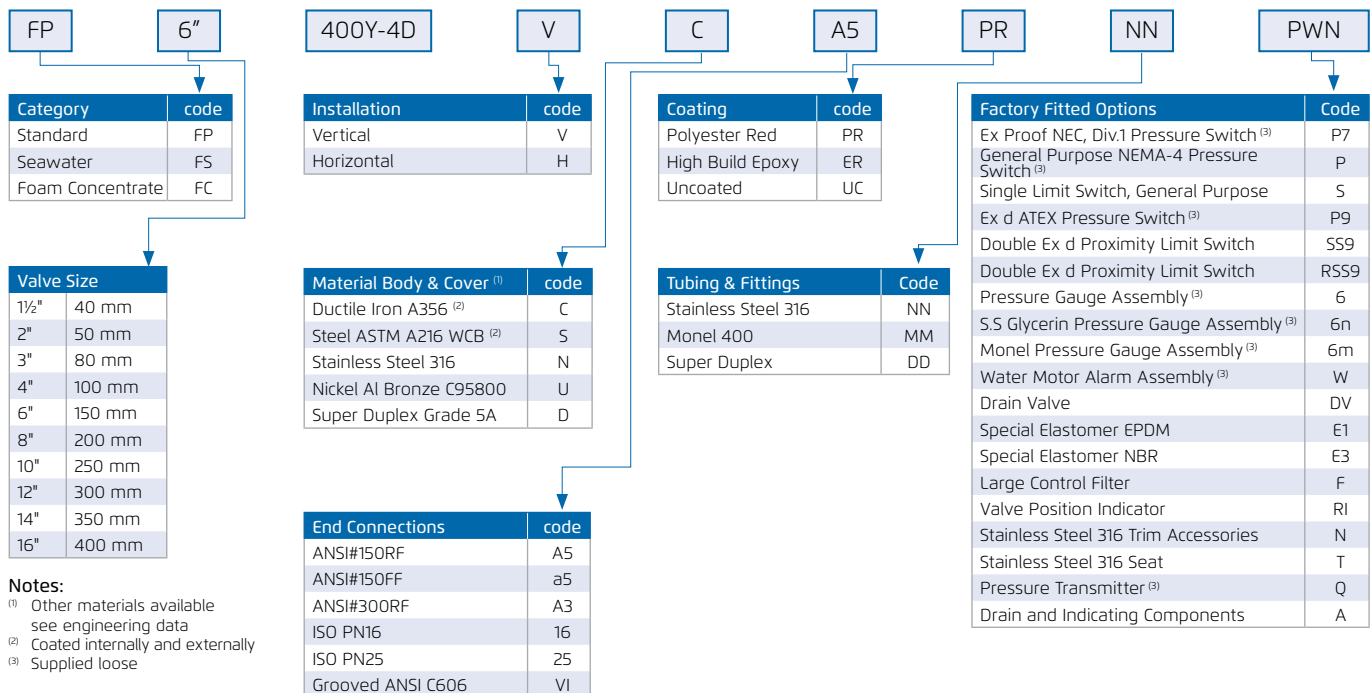

Notes:

⁽¹⁾ Other materials available see engineering data

⁽²⁾ Coated internally and externally

⁽³⁾ Supplied loose

