

Insertion Flow Meter Device (IFM)

BERMAD's IFM-MUT1222-PRV SENSOR is designed for measuring the flow rate of valves sized DN80 to DN600 (3" - 24"). This document describes the installation process of the sensor.

For larger diameter valves use model IFM-MUT1222.

The insertion sensor should be mounted at the upstream port of the control valve (the water entrance side to the valve). The device is designed to be mounted into 1" BSPT threaded port.

We recommend using a factory installed and calibrated device, however these processes can be also done in BERMAD's subsidiaries shop or on site.

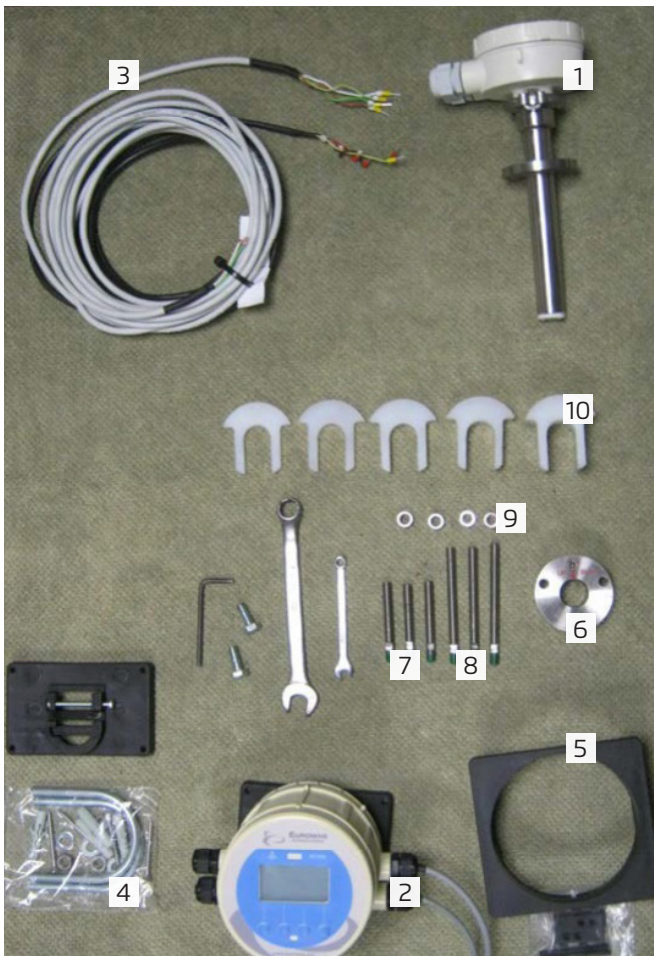

Parts List:

1. Sensor MUT1222-PRV separate version
2. Converter MC608A
3. Cable set
4. Wall/pole mounting kit
5. Panel mounting kit
6. Sealing disk + O-Ring
7. Stud bolt bolts M8 short
8. Stud bolt bolts M8 long
9. M8 nuts
10. Spacers

Step by step mounting instructions:



Apply Teflon sealing band on the sealing disk 1" thread

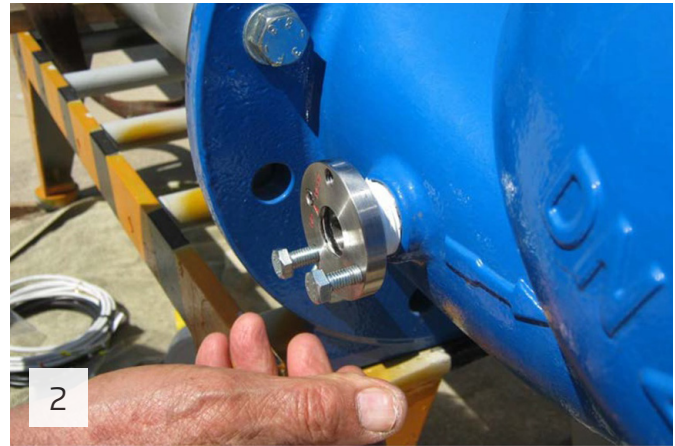

Screw the sealing disk into the 1" BSPT port; use two regular screws to lock the disk temporarily in the up-right position as indicated on the disk. Tighten the disk gently



Important: do not tie the sealing disk till the very end of its tread; only position it in the up-right position
* If overrides, unscrew it backwards to the correct position **Note:** Do not apply excessive torque, tighten gently!



Remove the temporary screws from the disk



Fasten the fixing screw using 4mm Allen key to prevent the disk from twisting

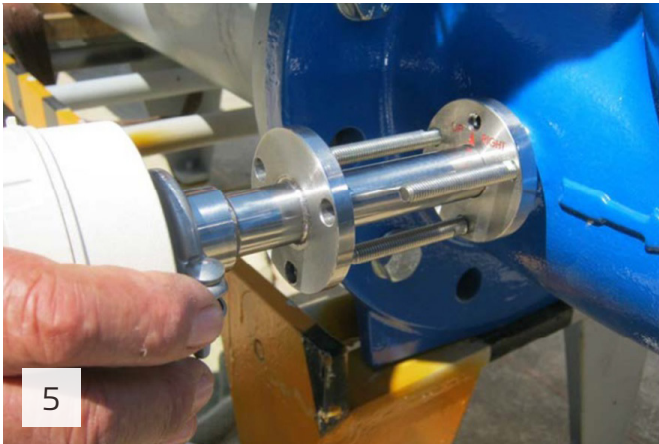

5

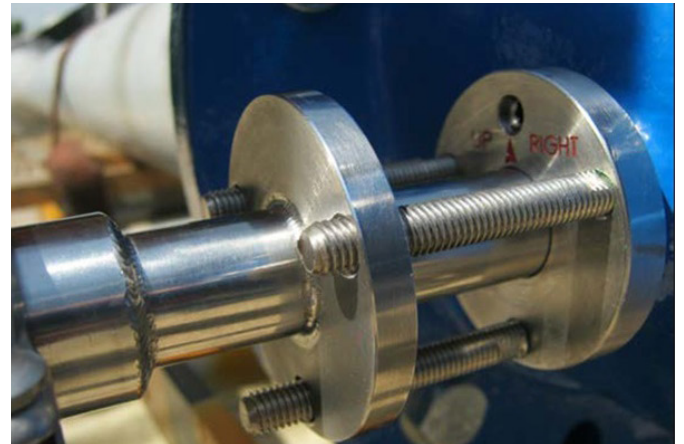

Use the table below to select the correct three 'Short' or 'Long' stud bolt according to the valve DN size. Use the supplied 6mm wrench to screw-in the painted green side of the stud bolt till the stud bolts are locked against their thread end

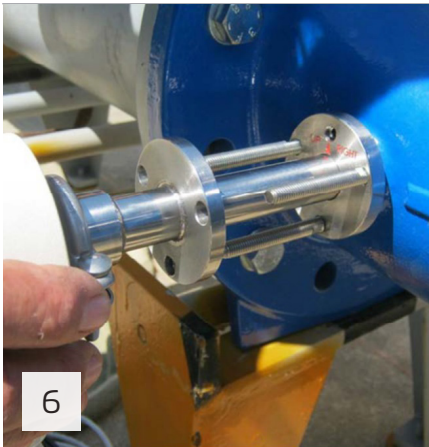

6

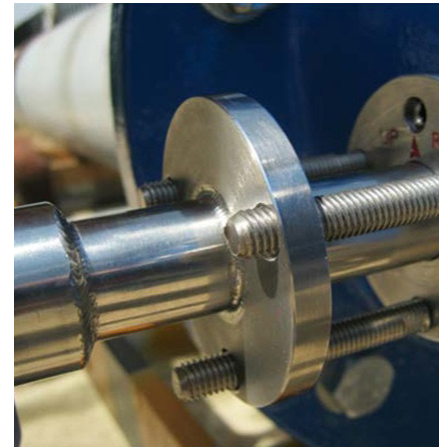

Carefully insert the sensor into the disk, make sure not to damage the O-ring
Note: that the sensor can be inserted in one position only

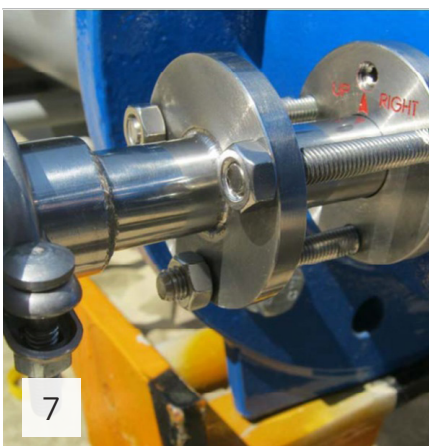

7

Screw the three 8mm nuts but do not lighten them yet

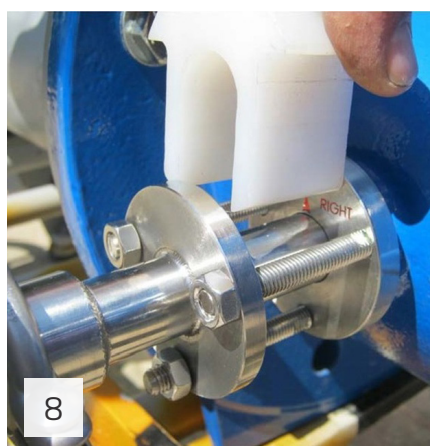

8

Select the correct spacer combination according to valve's size using the table below



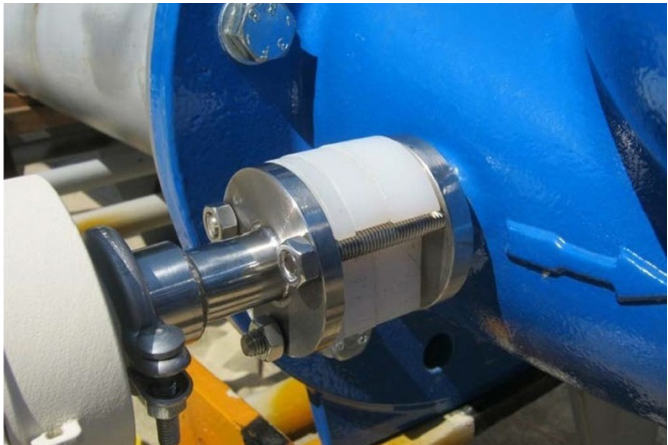
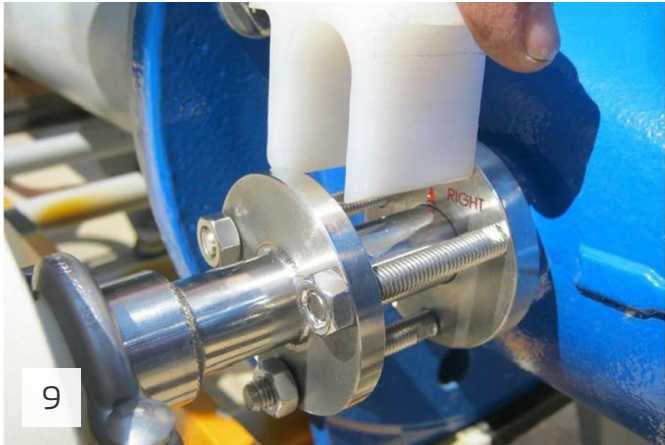

Tighten the nuts but make sure not to apply excessive torque, it may damage the plastic spacer

Spacer Combination Table

Size	Spacers Combination	Stud Bolts
600 / 24"	0 (none)	Short
500 / 20"	B	Short
450 / 18"	A+B	Short
400 / 16"	A+C	Short
350 / 14"	C+B	Short
300 / 12"	A+B+C (D)	Short / Long
250 / 10"	A+D	Long
200 / 8.0"	B+D	Long
150 / 6.0"	A+B+D (C+D)	Long
125 / 5.0"	A+B+D+E	Long
100 / 4.0"	A+C+D	Long
80 / 3.0"	A+C+D+E	Long
65 / 2.5"	A+C+D+E	Long
50 / 2.0"	B+C+D	Long

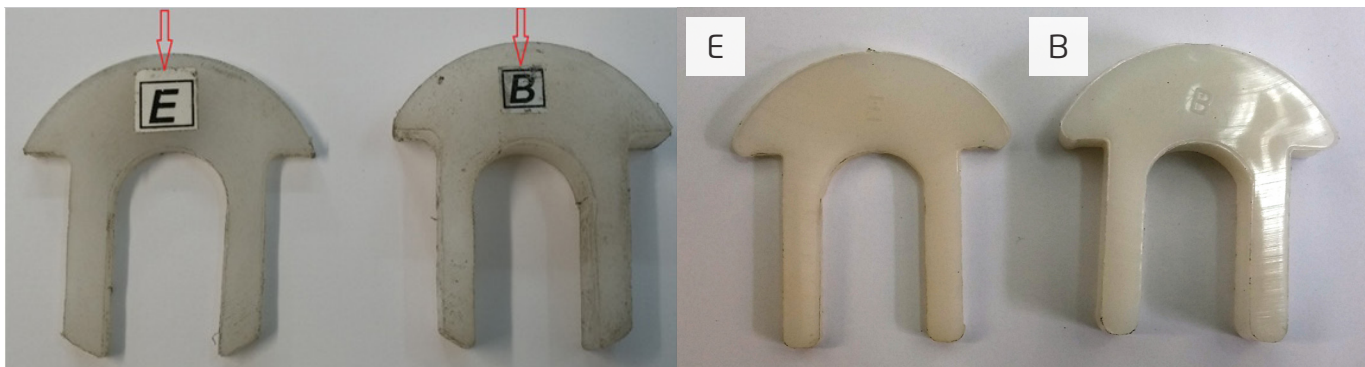

The picture above is an example of the spacer letter marks

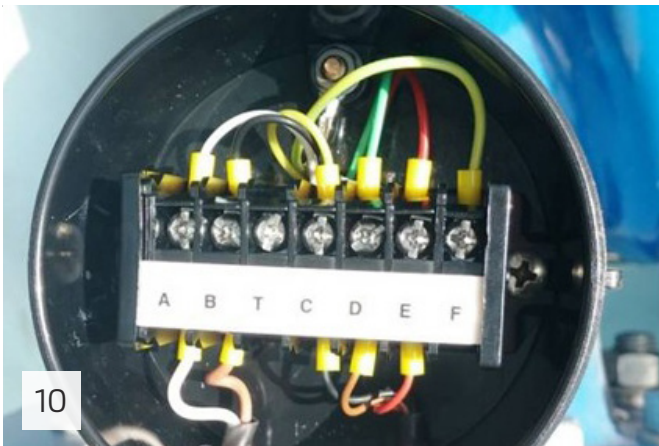

10

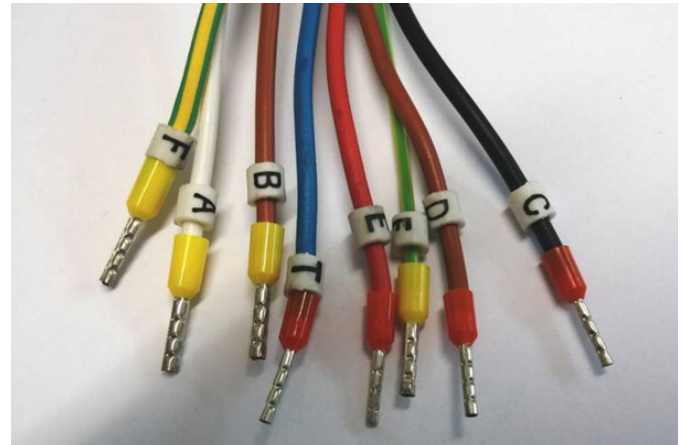

Note: Cables glands are factory oriented downwards. If necessary, slightly loosen the v-clamp nut (10mm key) and turn the box only by the minimum required to obtain a new position. Fasten back the v-clamp. Note that the Maximal permitted rotation is 180°.

11

For IP68 applications fill the junction box with resin locally, wiring and orientation must be processed first!

- Make sure that the system works ok before applying resin
- Remove the sensor from the line
- Leave the sensor vertically and not covered for 1 hour after filling to ensure Resin curing time

Sensor position

Please Note:

The sensor is calibrated for working on the up-stream right side port of the valve (as per below pictures).

Installing the sensor on the up-stream left side port will lead to negative readings.

In such case for obtaining positive reading, invert A and B cables; this inverts the magnetic field signal, and provides positive reading.

Negative reading does not affect the sensor accuracy.

Electronic connection between the sensor and the converter

CAUTION!

ANYWORK DONE ON THE ELECTRICAL JUNCTION BOX OR ELECTRICAL COMPONENTS OF THE DEVICE MUST BE CARRIED OUT BY PROPERLY TRAINED AND SPECIALIZED STAFF.



Converter connections box

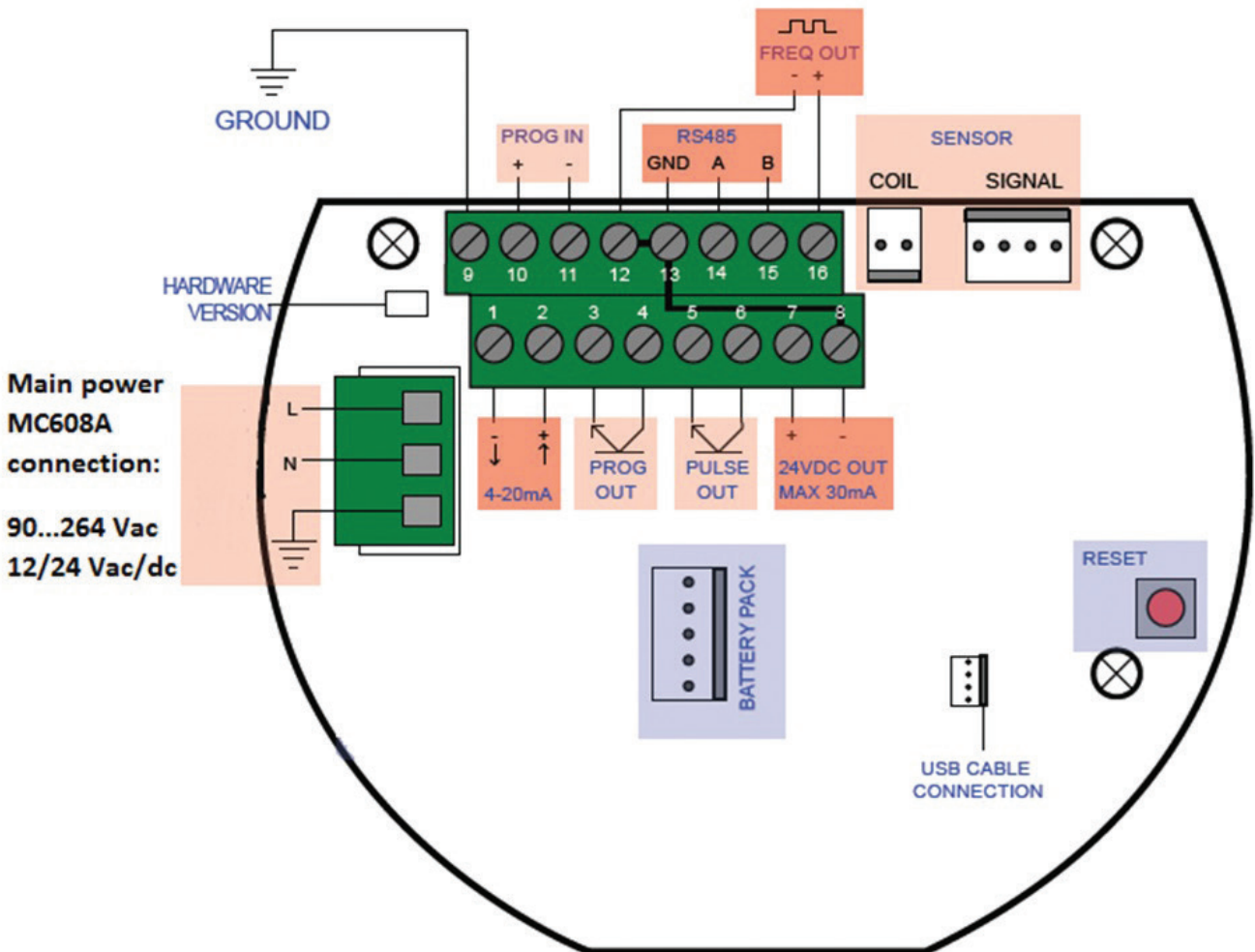

NOTE:
ELECTRICAL GROUNDING OF THE CONVERTER CASE

The MC608 case must be grounded. This connection should be carried out by grounding the bolt located at the lower part of the converter.

Connection to the power supply

CAUTION!

ELECTRICAL CONNECTION OF THE DEVICE MUST BE CARRIED OUT BY PROPERLY TRAINED SPECIALISTS.

Make sure that all the electrical connections are correctly performed before connecting the unit to the power supply.

Check the power voltage as depicted on the name plate.

The unit may be supplied with voltage:

MC608A: 90 - 264VAC or 12 ... 24VAC/DC

MC608B: Powered by a lithium battery
12 - 24VAC/DC

MC608R: Powered by a rechargeable lithium battery
12 - 24VAC/DC

Power supply and battery charging is supplied by the solar panel.

Programming the mc608 converter

MC608 configuration can be performed in the following methods:

- By the 4 push buttons located on the front display of the converter, under the front panel glass.
- Via PC through the RS485 MODBUS output (see electrical connections) and the Euromag MC608 configuration software program. USB cable adapter is available at the manufacturer on request.
- From a PC via the infra-red port located on the front of the converter above the display, and the MC608 Euromag configuration software.

Activation of the MC608B or MC608R in battery mode:

The normal operation mode of the MC608B is the "sleep mode". This mode preserves battery life while ensuring functional operation of the product.

To recall the unit for reading the display or changing the program settings use the supplied magnetic swipe and slide it vertically on the front panel of the converter at the "activate" marking.

Programming

To access the menu from the converter's display, simply press the relevant button below the function.

Enter the Menu by pressing the Menu button.

MENU:

- Options
- Counters
- Parameters
- I/O
- Other
- Memory

Follow the chart below for an overview of the available functions.

Options	Counters	Parameters	I/O	Other	Memory
Technical units	T+	Ka setup	Pulses OUT	System info	Load user copy
Flow rate units	P+ (set zero)	Diameter Setup	Pulse quantity	Time/Date	Save user copy
Flow rate time base	T-	Filters setup	Pulses time ON	Reserved	Factory settings
Counters module	P- (set zero)	Flow cut off	Reverse flow rate	Graph	Data logger
Pulses unit		Damping	Pulses out enable	Simulation	Show last row
Specific weight		Bypass	Frequency output	Communications	Full erase
Temperature unit		Peak cut	Full scale freq.	Baud rate RS485	LOG range
Measurement frequency		Measure average	Frequency output enable	MODBUS address	Password setup
Measuring time		Line frequency	Program. Output	Data connection	
Display		Zero calibration	Enabled/disabled		
LCD backlight lev		Flow rate alarms	Reverse Flow		
Backlight off		MAX flow th.	MAX flow th.		
LCD contrast		MIN flow th.	MIN flow th.		
View options		Empty Pipe th.	MAXIMIN flow th.		
Last row			Batching		
Full scale flow			Excitation failure		
Language			Empty Pipe		
			Program. Input		
			Enabled/disabled		
			Zeroing p+		
			Zeroing p-		
			Zeroing p+/p-		
			Batching		
			Progr. output logics		

Data to be displayed

The display is divided into three main areas:

- The top area shows** the symbols for status information together with the indication on the duration of the battery (MC608B and MC608R).
Power indication (MC608A) or indication on battery.
Supply and charging (MC608R), as well as the alarm symbols and real-time reading of the flow rate.
- The central area shows** a linear graph of the flow rate shown in percentage on the full scale flow rate.
- The area at the bottom** can be selected by the customer; the possible options are:
T+ total positive counter
P+ partial positive counter
T- total negative counter
P- partial negative counter
Date and time, temperature or pressure display (the latter available with optional module).

To select the required value simply click on the button corresponding the arrow and make your selection, or select:



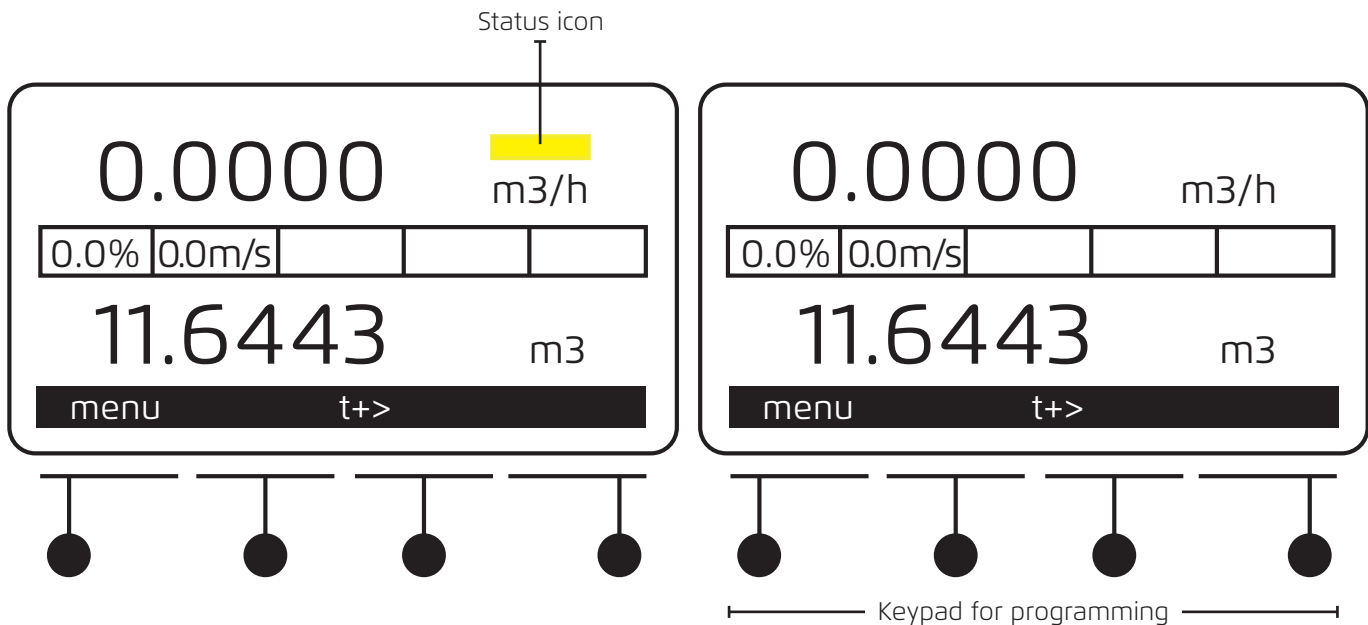





Menu -> Options -> view options -> Last row



STATUS ICONS / POWER SUPPLY

- Power Supply
- Power Batteries (remaining)
- Charging Batteries (rechargeable version)

ALARM ICONS

	flow rate > MAX threshold
	flow rate < MIN threshold
	excitation failure
	measurement error
	empty pipe alarm
	alarm for pulses accumulation
	board temperature alarm (with unit set)
	low voltage alarm
	full data logger alarm

COMMUNICATION STATUS

	Data connection in progress
---	-----------------------------

Calibration Process:

NOTE: it is always recommended to order the **IFM and the VALVE** connected and factory calibrated.

In case this is not possible, there are two options:

1. On-site Laboratory calibration (always recommended)
2. Field Calibration (when there is no other choice)

Laboratory calibration procedure:

NOTE: please ensure selection of the right **calibration spacer** (according to the "Spacer Combination Table").

Test Method

Comparison between the IFM Meter to be calibrated and the Test-Bench Master Meter

NOTE: Before starting the calibration ensure that proper grounding is connected!

Steps:

1. Clamp the device, Open the water, and make sure there are no leaks.
2. Release air by initiating flow through the water meter.
3. Make, **zero calibration**.

Options > Parameters

↓
Zero calibration

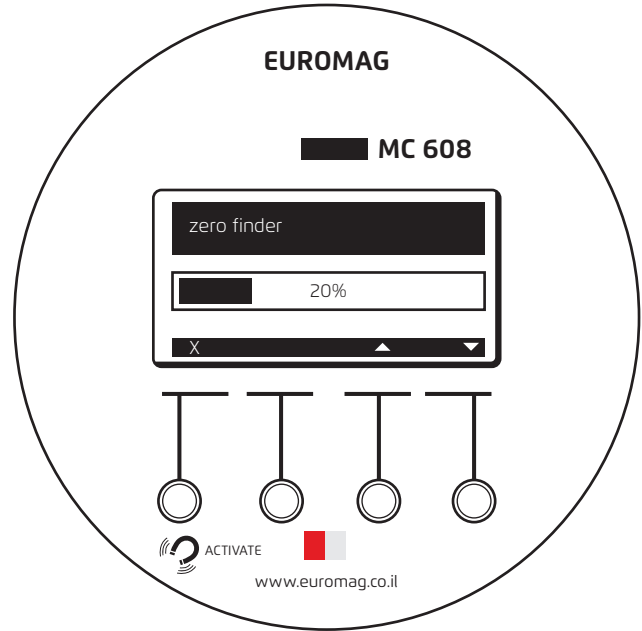
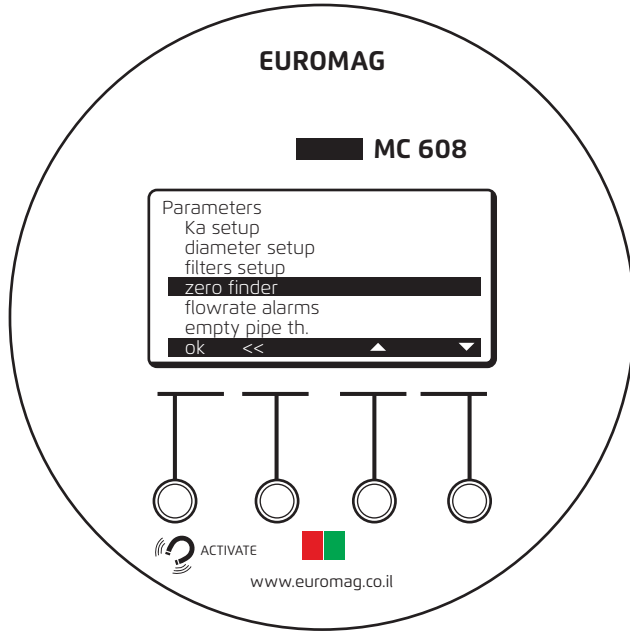

NOTE:

The MC608 has an automatic zero calibration function. Use the zero finder only when strictly necessary.

NOTE:

If double regulating valves are not present for regulating flow rates, use the testing Valve as ON/OFF Valve.

4. Measuring accuracy test at two points 1.0m/s and 3.0m/s. repeat each test twice.
Minimum test time should be at least 5 Minutes.
5. Calculate the error according to the explanation in the "Measurement error calculations".
6. Compliance - End calibration.

NOTE:

in order to enter or change the diameter the technician password is required.

Technician password: 231042

Options > Memory

↓
Password setup

7. Non-compliance –

Calibration the IFM by changing the diameter

- Positive error above the allowable
> Reduce the IFM diameter size.
- Negative error above the allowable
> Increase the IFM diameter size.

8. After calibration, repeat the test in section 3 until result are in compliance.

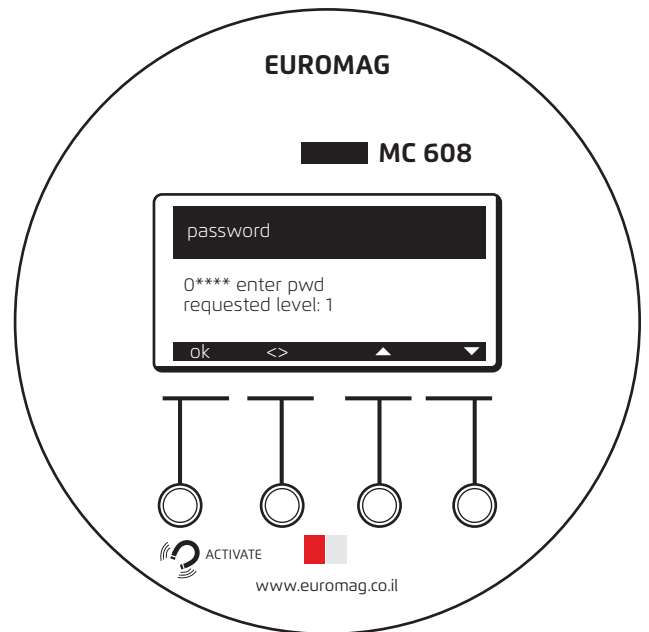

Options > Parameters

↓
Diameter Setup

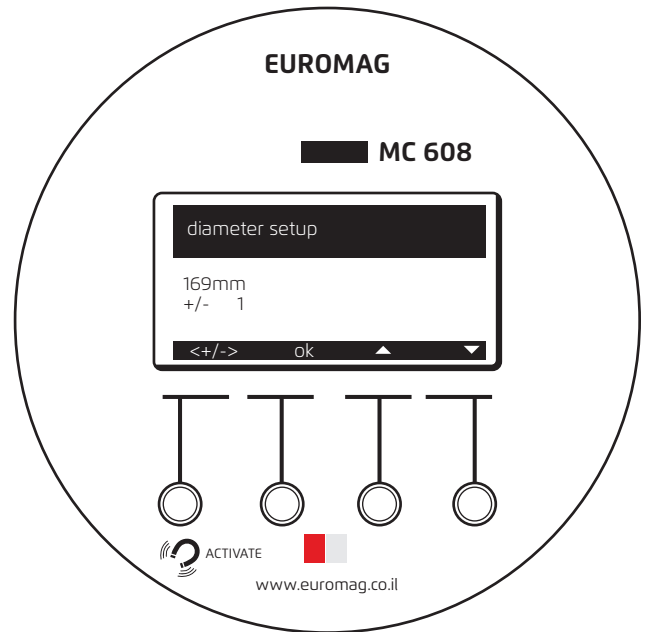
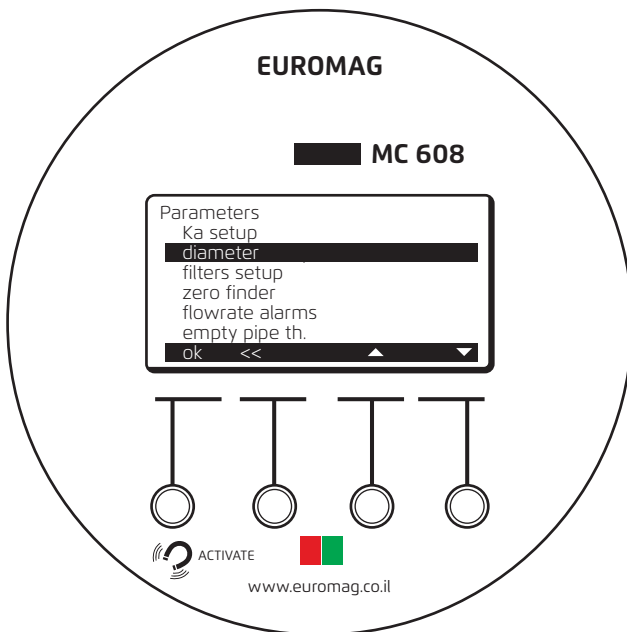

Measurement error calculations

Calculate the corrected electromagnetic flow-meter (master) reading using the equation

$$\text{IFM Accuracy} = 100\% \times \frac{\text{Master} - \text{IFM}}{\text{Master}}$$

Compliance and non-compliance

Compliance error ±2.5% (in measured points 1.0m/s and 5.0m/s)

Non-compliance **above** ±2.5% (in both measured points 1.0m/s and 5.0m/s)

Field Calibration:

NOTE: Field Calibration is less recommended than Laboratory calibration, the accuracy will be $\pm 5.0 \sim 10 \%$ depends on the calibration method and on the master meter accuracy. The field calibrating is not authorized by any standard.

There are 3 options for field calibrating:

- Calibration based on comparison to other **flow meter on-site**.
- Calibration based on comparison to **volumetric tank on-site**.
- Calibration based on comparison with temporary flow meter such as **Clamp-on ultrasonic flow meter** which is installed only for this purpose. For this we recommend to use Clamp-on ultrasonic flow meter model: FLUXUS F601.

In these three options the Test Method is the same as in the Laboratory calibration procedure only with difficulty performing the required Flow / Amount.

Trouble-Shooting:

SYMPTOMS: The converter shows a flow rate under static or no flow conditions.

POSSIBLE REMEDIES:

- There is air in the pipe, try to avoid the creation of bubbles by selecting a more suitable position for the sensor (see installation paragraph).
- Check that the sensor is fully inserted to the liquid.
- Electrical conductivity of the liquid is too low or is not compatible with the material used for the sensor electrodes.
- Perform manual zero calibration if necessary (Menu - Parameters, sub- menu - zero calibration).

SYMPTOMS: Flow reading is highly unstable

POSSIBLE REMEDIES:

- Air bubbles or unstable flow. The minimum required linear distances upstream and downstream of the device are not met.
- Missing grounding or incorrectly done, oxidized nodes, very noisy ground point, usually in common with the grounding systems of pumps or inverters. Change the grounding point or preferably install a new one for the exclusive use of the meter.

NOTE: If with full pipe and stable liquid an unstable reading is observed (which varies rapidly) then most likely it is a problem of electrical noise.

Only if necessary, set the filters as follows:

- Set Damping to 150
- Reduce the peak cut filter
- Increase the bypass filter

SYMPTOMS: The display is off and does not turn on.







POSSIBLE REMEDIES: There is no voltage supply, or the voltage supply is incorrect. Check the power supply voltage on the name plate of the converter. In case of MC608B check the battery life and replace the battery pack.

SYMPTOMS: Liquid is flowing and the pipe is full, but NO reading is available.

POSSIBLE REMEDIES: Reduce the flow cut off filter (factory settings is 2% of the full scale).

NOTE: Should you need to reduce the flow cut off filter, it means the speed of the liquid is lower than that recommended for an accurate measurement. It is advisable to lower the full scale (120% of the maximum of the process).

ALARM MESSAGES POSSIBLE CAUSES AND SOLUTIONS

<p>Excitation failure </p>	<ul style="list-style-type: none"> • Incorrect connections of cables • Sensor damaged. Damaged lining or electrodes. Possible infiltration of liquid inside the sensor • Converter damaged <p>It is recommended to perform a test on the sensor -> circuit between coils A - B: 50 - 250 Ohm Request the "sensor test" to the factory</p>
<p>Measurement error </p>	<ul style="list-style-type: none"> • Empty Pipe • Air bubbles within the liquid • Incorrect electrical grounding <p>It is advisable to check for correct installation of the sensor in the three points indicated and carry out a test on the sensor -> with full pipe (A or B) - ground > 100 MOhm</p>
<p>Empty Pipe </p>	<ul style="list-style-type: none"> • Empty pipe detection <p>This message is displayed with sensors that have 4 electrodes. Indicates the alarm of empty pipe, or even only partially empty. In case of persistent message with full pipe (more than a few minutes) act on the empty pipe threshold (see section 10.3.6 Empty pipe threshold).</p>
<p>Pulses accumulation </p>	<ul style="list-style-type: none"> • Pulse frequency incorrect <p>It is advisable to change the volume settings and pulse duration. See the section for pulse output setting</p>
<p>Supply voltage </p>	<ul style="list-style-type: none"> • Supply voltage out of operating range • Converter damaged <p>Check the power supply network</p>
<p>Data logger full </p>	<ul style="list-style-type: none"> • Data logger memory full <p>It is advisable to download the data to PC, and erase the memory of the converter</p>

Spare Parts:

- 1" sealing disk and O-Ring
- Spacer - diameter adaptors set
- Cable set for 5m or 10m
- Grounding rings
- Bottle of sealing resin for sensor's junction box
- Pressure sensor – 21Y Series made by KELLER
- PT 500 Probe
- Cable for Pressure sensor