

# Manually Operated Monitor / Deluge Valve

## Model FP 400Y - 1D

The BERMAD model 400Y-1D is an elastomeric hydraulic, line pressure operated deluge valve, designed specifically for advanced fire protection systems and the latest industry standards.

The 400Y-1D is activated manually by opening the local Manual Release Valve attached to the valve's control trim.

The 400Y-1D is ideal for use as a locally operated deluge valve for water spray or foam system nozzles.

It is also well suited for installation directly before high capacity water/foam monitors as a Listed/Approved quick opening water control valve.

As standard the release valve is positioned locally on the valve, optionally the release valve can be positioned remotely enabling valve operation from a distance.

The optional valve position indicator can include a limit switch suitable for Fire & Gas monitoring systems.



(for illustration only)

### Benefits and Features

- **Safety and reliability**
  - UL-Listed quick opening water control valve
  - Simple time tested fail-safe actuation
  - Single piece, rugged elastomeric VRSD technology
  - Obstacle-free, uninterrupted flow path
  - No mechanical moving parts
  - Valve position limit switches (optional)
  - Local valve position indicator beacon (optional)
- **High performance**
  - Very high flow efficiency
  - Straight through flow Y- type body
  - UL-Listed for PN25 / 365 psi
- **Designed for fire protection**
  - Face-to-face length standardized to ISO 5752 / EN558-1
  - Meets the requirements of the industry standards
- **Quick and easy maintenance**
  - In-line serviceable
  - Quick and easy cover removal

### Typical Applications

- Water spray or foam system nozzles.
- Fire monitor valves
- Manually operated deluge valve
- Hydraulic remote controlled systems
- Oil & Gas storage tanks

### Approvals



UL-Listed  
Special System Water Control Valves, Deluge Type (VLFT)  
Sizes 3" - 10"



Det Norske Veritas  
Type Approval



ABS  
American Bureau of Shipping  
Type Approval



Lloyd's Register  
Type Approval

### Additional Features

- Valve position limit switches
- Local valve position indicator beacon
- Hydraulic remote Manual Release station
- Seawater compatibility
- Drain valves - inlet and / or outlet

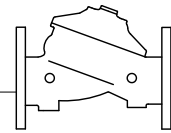

## Operation

(for illustration only)

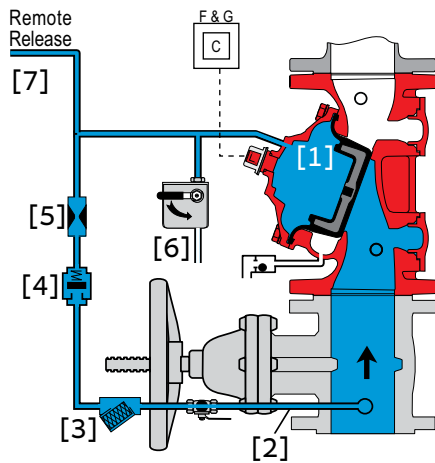

**Valve Closed** (normal conditions)

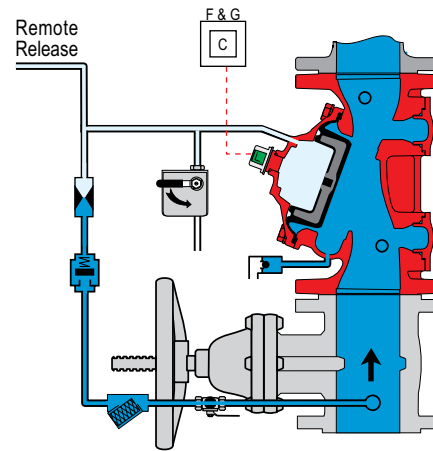

**Valve Open** (fire conditions)

The BERMAD model 400Y-1D is held closed by water pressure in the control chamber [1]. Upon release of pressure from the control chamber, the valve opens.

Under NORMAL conditions, water pressure is supplied to the control chamber via the priming line [2] strainer [3], and a restriction orifice [5]. The water pressure is then trapped in the control chamber by the check valve [4], and a manual release valve [6].

Under FIRE conditions, water pressure is released from the control chamber, by opening the local manual release or, when fitted, by opening the hydraulic remote Manual Release [7]. This opens the deluge valve allowing water to flow into the system piping and to the fire extinguishing devices.

## System P&ID

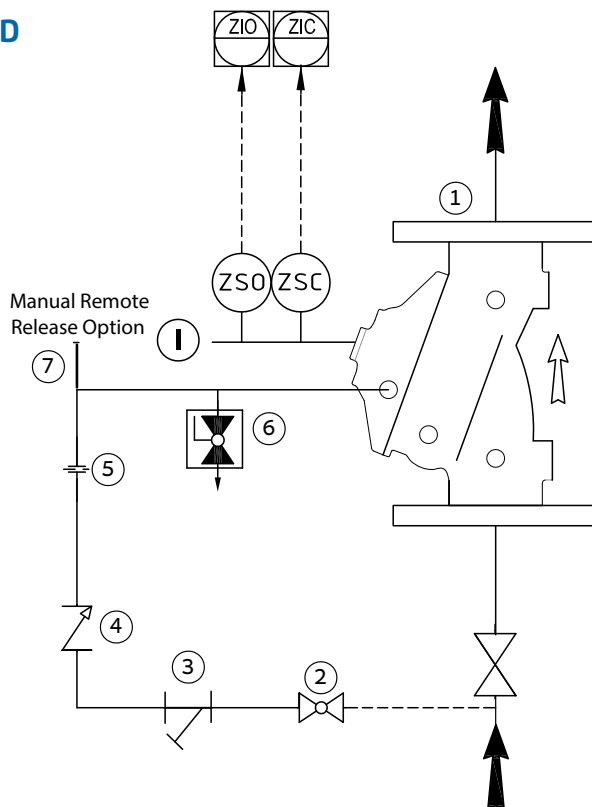

### Components

- 1 BERMAD 400Y deluge valve
- 2 Priming ball valve
- 3 Priming strainer
- 4 Check valve
- 5 Restriction orifice
- 6 Manual release

### Optional System Items

- 7 Manual Remote release
- ZS Limit Switch Assembly
- I Visual Indicator

See also Factory Fitted Options under the Valve Code Designations on the last page

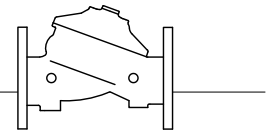

## System Installation

A typical installation of the BERMAD model 400Y-1D features manual actuation via a 2 way release valve positioned either remotely or on the main valve's trim.

When fitted with a limit switch the valve can send a feedback signal to the remote valve position monitoring system.

## Optional System Items

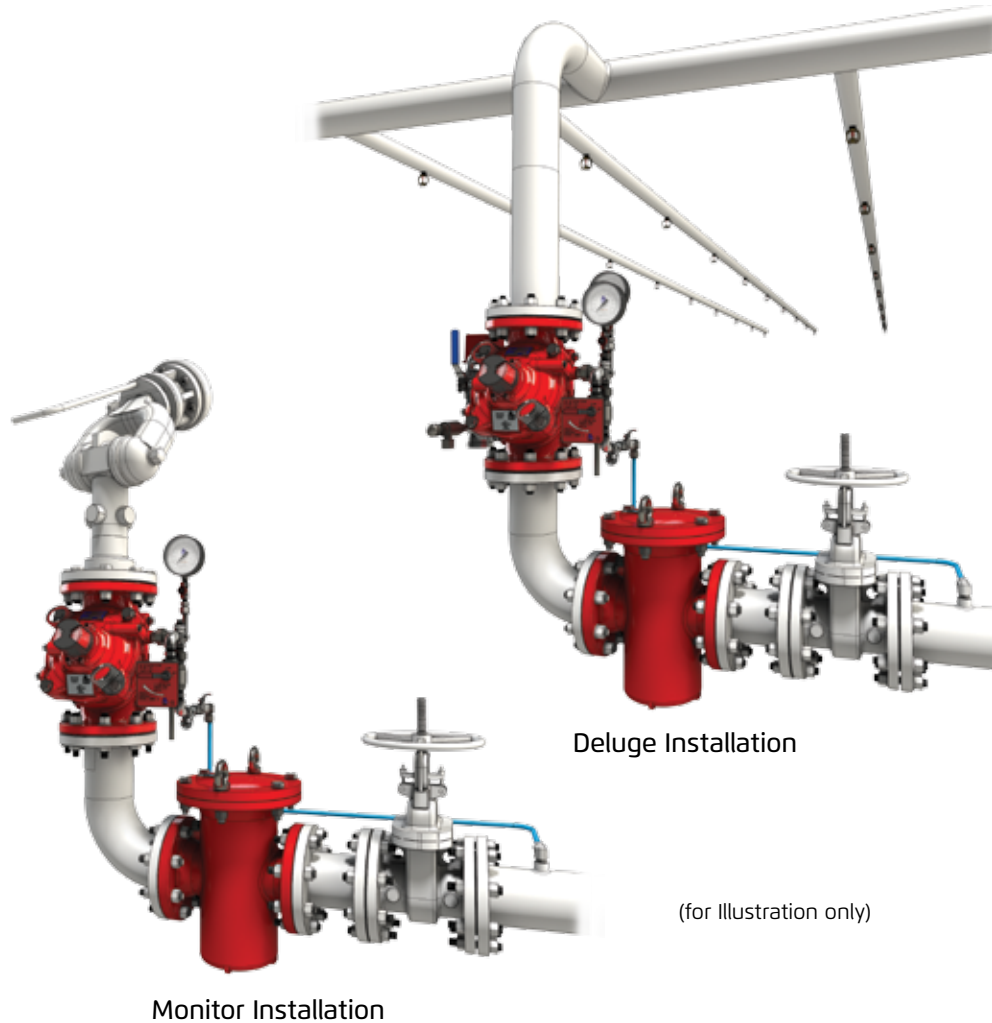
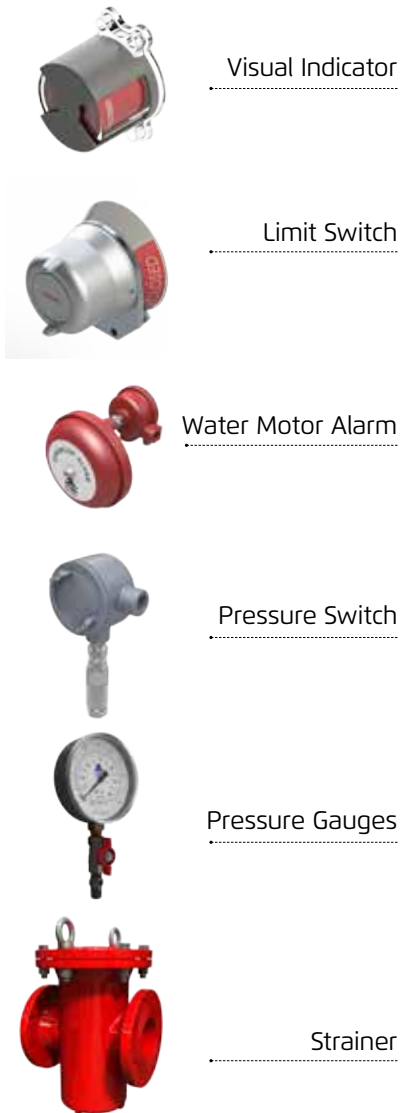

## Suggested Specifications

The deluge valve shall be an UL listed, 25 bar / 365 psi rated, elastomeric-type, with a straight-through, Y-type-body.

The valve shall have an unobstructed flow path, with no stem guide or supporting ribs.

Valve actuation shall be accomplished by a single piece rolling diaphragm, bonded with a rugged radial seal disk.

The diaphragm assembly shall be the only moving part. The deluge valve shall include a Y-type strainer, a ball drain valve, and a manual emergency release with stainless steel mounting panel.

The valve shall be equipped with a dual-colour, rotational position indicator, readable from 50 meters, and with two limit switches enclosed in a protective switch box.

Removing the valve cover for inspection or maintenance shall be in line and not require removing the control trim.

The deluge valve and its entire control trim shall be supplied pre-assembled and hydraulically tested by a factory certified to ISO 9000 and 9001 standards.

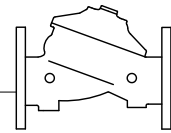

## Technical Data

### Available Sizes (inch)

- Flanged - 1½, 2, 3, 4, 6, 8, 10, 12, 14 & 16"
- Grooved - 1½, 2, 3, 4, 6 & 8"
- Threaded - 1½ & 2"

### Pressure Rating

- ANSI#150 - 16 bar / 235 psi
- ANSI#300 - 1½" to 10" 25 bar / 365 psi  
12" to 16" 20 bar / 300 psi
- Grooved / Threaded - 25 bar / 365 psi

### Elastomer

- HTNR - Fabric Reinforced High Temperature Compound - See engineering data

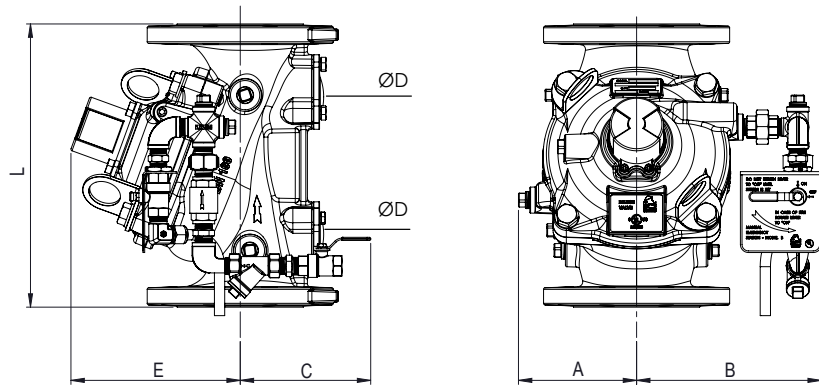

Valve Size	1½" DN40		2" DN50		3" DN80		4" DN100		6" DN150		8" DN200		10" DN250		12" DN300		14" DN350		16" DN400	
	mm	in	mm	in	mm	in	mm	in	mm	in	mm	in	mm	in	mm	in	mm	in	mm	in
L <sup>(1)</sup>	230	9.1	230	9.1	310	12.2	350	13.8	480	18.9	600	23.6	730	28.7	850	33.5	980	38.6	1,100	43.3
L <sup>(2)</sup>	230	9.1	238	9.4	326	12.8	368	14.5	506	19.9	626	24.6	730	28.7	888	35	980	38.6	1,100	43.3
A	84	3.3	84	3.3	144	5.7	152	6.0	205	8.1	235	9.3	235	9.3	348	13.7	348	13.7	348	13.7
B	161	6.3	161	6.3	219	8.6	204	8.0	284	11.2	312	12.3	312	12.3	425	16.7	425	16.7	425	16.7
C	248	9.8	248	9.8	281	11.1	297	11.7	312	12.3	327	12.9	327	12.9	390	15.4	390	15.4	415	16.3
ØD	¾"		¾"		1½"		2"		2"		2"		2"		2"		2"		2"	
E	120	4.7	120	4.7	146	5.7	158	6.2	228	9.0	295	11.6	295	11.6	441	17.4	441	17.4	415	16.3
Kv / Cv	68 / 79		80 / 92		190 / 219		345 / 398		790 / 912		1160 / 1340		1355 / 1565		2370 / 2737		2850 / 3292		3254 / 3758	
Leq <sup>(3)</sup> : m/ft	2 / 7		5 / 16		7 / 23		9 / 30		15 / 49		27 / 89		62 / 203		52 / 171		59 / 194		88 / 289	
kg / lb Approx (flanged#150)	11.2 / 24.7		12.6 / 27.8		27.3 / 60.2		37.3 / 82.2		81 / 178		144 / 317		174 / 383		317 / 698		350 / 771		396 / 873	

Notes: <sup>(1)</sup> Refers to the length dimensions for Raised Face ANSI #150, ISO 16 Flanged, Threaded and Grooved valves

<sup>(2)</sup> Refers to the length dimensions for Raised Face ANSI #300 and ISO 25 Flanged valves

<sup>(3)</sup> Leq (Equivalent Pipe Length) refers to turbulent flow in new steel pipe schedule 40, values given for general consideration only

<sup>(4)</sup> Dimensions for the trim envelope may vary with specific component positioning

## Valve Code Designations

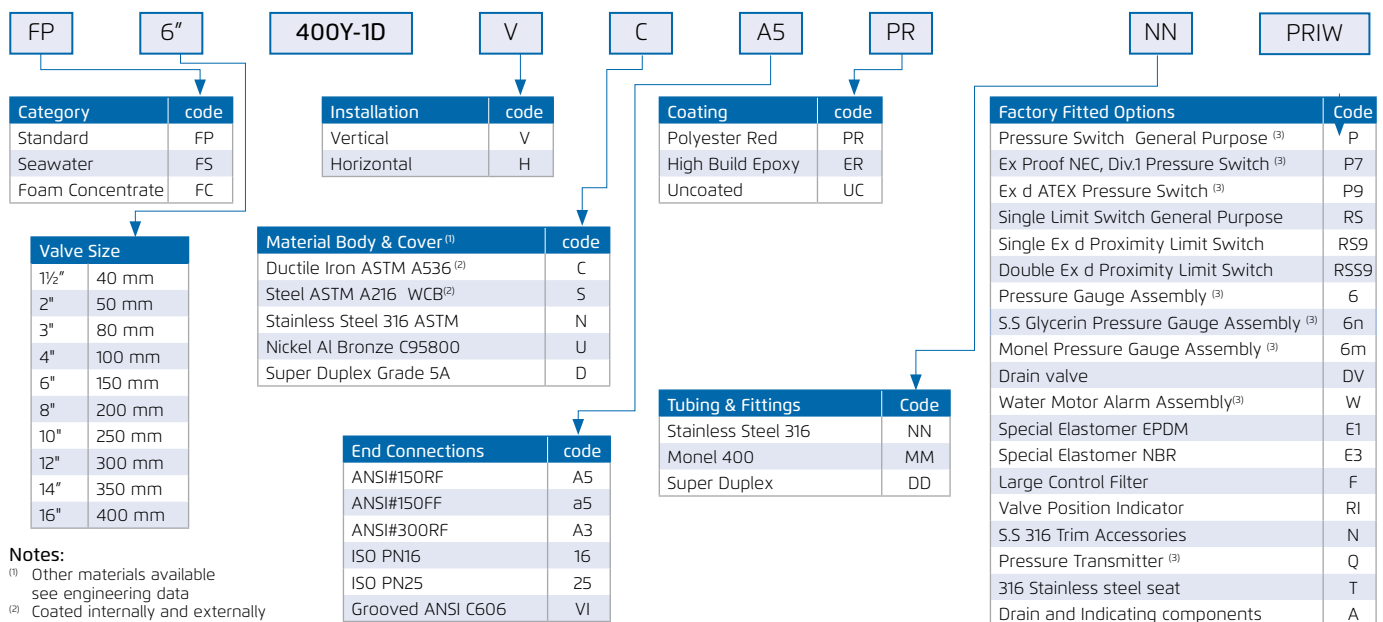

### Notes:

<sup>(1)</sup> Other materials available see engineering data

<sup>(2)</sup> Coated internally and externally

<sup>(3)</sup> Supplied Loose

