



Electric Pressure Control On-Off Deluge Valve

Model FP 400Y - 2DC

The BERMAD model 400Y-2DC is an elastomeric, hydraulic, line pressure operated deluge valve, designed specifically for advanced fire protection systems and the latest industry standards.

The 400Y-2DC is activated by a 2-way solenoid valve by which opening and closing of the deluge valve may be controlled remotely.

An integrated pressure reducing pilot ensures a precise and stable pre-set downstream water pressure.

The 400Y-2DC is ideal for open-nozzle systems with a high pressure water supply and is available with electric components to suit any hazardous location.

The optional valve position indicator can include a limit switch suitable for Fire & Gas monitoring systems.

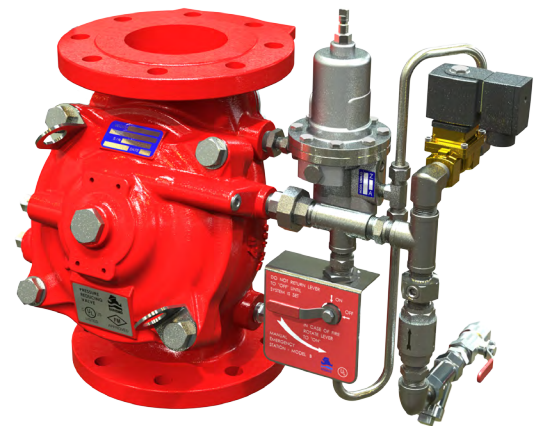

(for Illustration Only)

Benefits and Features

- **Safety and reliability**
 - Time-proven, simple, fail-safe actuation
 - Single-piece, rugged, elastomeric diaphragm sea VRSD technology
 - Obstacle-free, uninterrupted flow path
 - No mechanical moving parts
 - Shuts off on remote command
 - Ensures precise, stable downstream water pressure
 - Valve position limit switches (optional)
- **Designed for fire protection**
 - Face-to-face length standardized to ISO 5752, EN 558-1
 - Meets the requirements of the industry standards
- **Quick and easy maintenance**
 - In-line serviceable
 - Fast and easy cover removal
 - Swivel mounted drain valves*

* not including 1½" & 2" valves

Typical Applications

- Remote control water spray systems
- Foam applications
- Corrosive water supplies
- High pressure water supply

Approvals



UL-Listed
Special System Water Control
Valves, Deluge Type (VLFT)
Sizes 3" - 10"



Det Norske Veritas
Type Approval



ABS
American Bureau of Shipping
Type Approval



Lloyd's Register
Type Approval

Additional Features

- Valve position limit switches
- Sea water compatibility
- Alarm pressure switch
- Drain valve/s inlet/outlet
- For "automatic activation" select BERMAD local or remote reset model

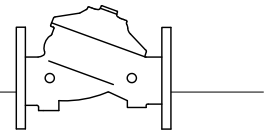

Operation

(for Illustration Only)

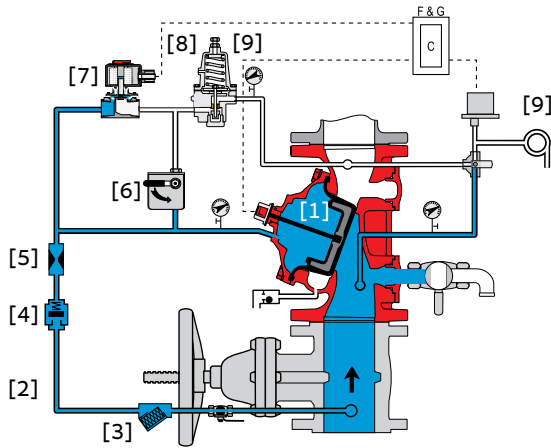

Valve Closed (normal conditions)

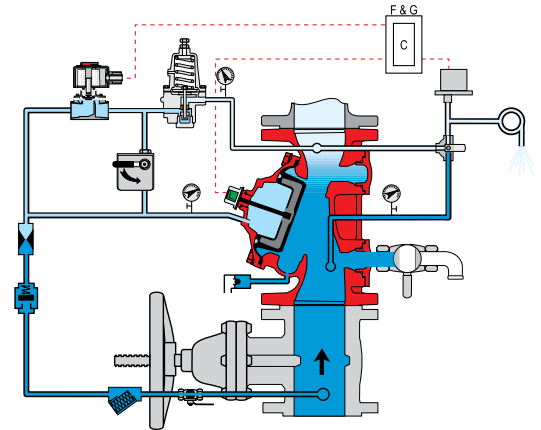

Valve Open (fire conditions)

The BERMAD model 400Y-2DC is held closed by water pressure in the control chamber [1]. Upon release of pressure from the control chamber, the valve opens.

Under NORMAL conditions, water pressure is supplied to the control chamber via the priming line [2] restriction orifice [5], and strainer [3], and is then trapped in the control chamber by a check valve [4], manual emergency release [6], and a relay valve (HRV) [7] that is held closed by hydraulic pressure supplied through a 2-way solenoid valve [8]. The water pressure trapped in the main valve control chamber holds the diaphragm against the valve seat, sealing it drip-tight and keeping the system pipes dry.

Under FIRE conditions, water pressure is released from the control chamber, either with the manual emergency release, or by the HRV opening in response to the solenoid valve being activated by the fire & gas control system [C]. This opens the 400Y-2DC deluge valve, allowing water to flow into the system piping and to the alarm device [10].

The pressure-reducing pilot valve [9] senses changes in outlet pressure and, modulates the main valve to maintain the set downstream pressure. When outlet pressure rises above the pre - set pressure value, the pilot valve throttles, enabling pressure to accumulate in the control chamber. This causes the main valve to close further and reduce outlet pressure, keeping the outlet pressure at the set value. When outlet pressure falls, the pilot valve opens wider, releasing pressure from the control chamber. This causes the main valve to open wider and increase outlet pressure.

System P&ID

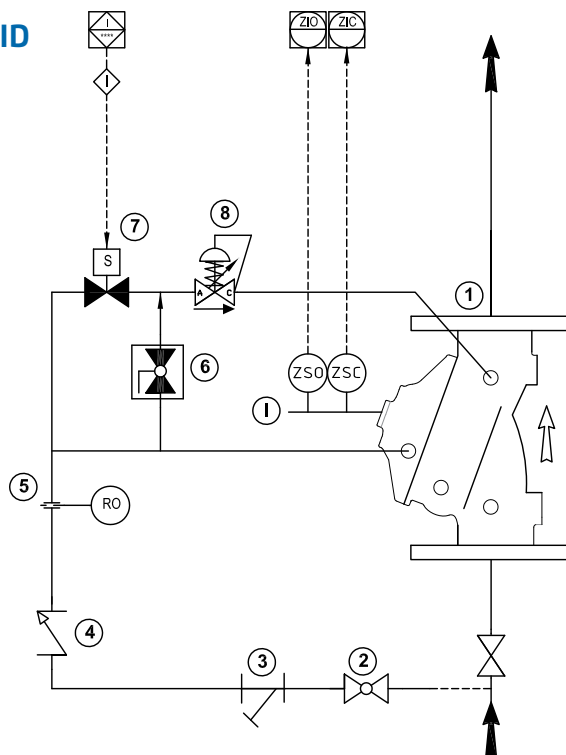

Components

- 1 BERMAD 400Y Deluge Valve
- 2 Priming Ball Valve
- 3 Priming Strainer
- 4 Check valve
- 5 Restriction Orifice
- 6 Manual Emergency Release
- 7 2-way Solenoid valve
- 8 Pressure Reducing Pilot Valve

Optional System Items

- ZS Limit Switch Assembly
- I Visual Indicator

See also Factory Fitted Options under the Valve Code Designations on the last page





System Installation

A typical installation of the BERMAD model 400Y-2DC features actuation via a hydraulic relay valve and 2-way solenoid valve, triggered by a signal from a fire & gas control system or an on-site emergency pushbutton. When open, and fitted with a limit switch the valve can send a feedback signal to a remote valve position monitoring system.

A pressure reducing pilot valve integrated in the control trim ensures a precise and stable pre-set downstream water pressure.

Optional System Items

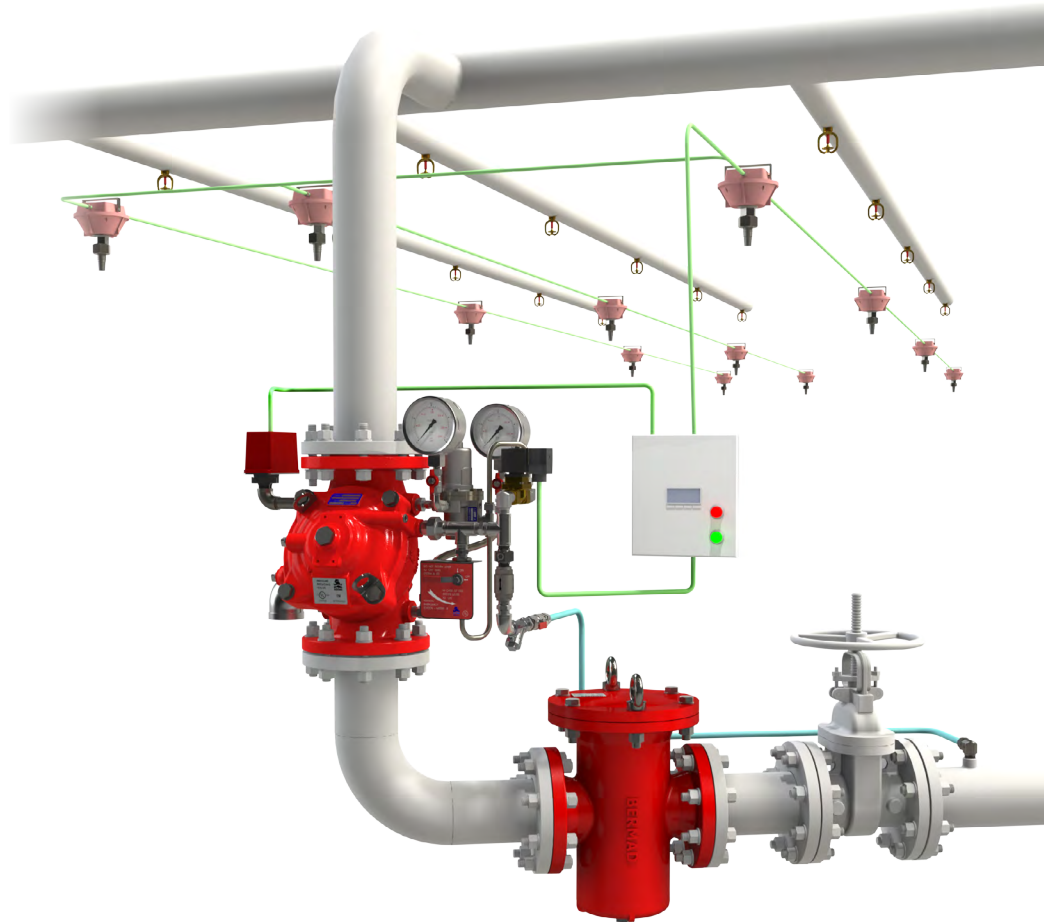
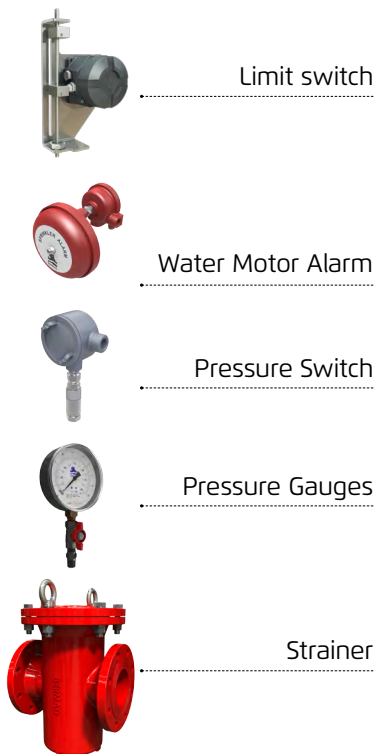

(for Illustration Only)

Suggested Specifications

The deluge valve shall be a UL listed, 25 bar/365 psi rated, elastomeric-type, with a straight-through, Y-type body. The valve shall have an unobstructed flow path, with no stem guide or supporting ribs.

Valve actuation shall be accomplished by a single-piece rolling diaphragm, bonded with a rugged radial seal disk. The diaphragm assembly shall be the only moving part. The deluge valve shall include a relay pilot valve, a 2-way solenoid valve approved for 25 bar (365 psi) working pressure with a tolerance of 35% below the rated voltage.

The trim shall include a Y-type strainer, a ball drain valve, an automatic drip-check with manual override, 4-inch pressure gauges and a manual emergency release housed in a stainless steel box. The valve drain socket shall be flanged and have a 360 degree swivel.

The valve shall be equipped with two limit switches.

Removing the valve cover for inspection and maintenance shall be in-line and not require removal of the control trim.

The deluge valve and its entire control trim shall be supplied pre-assembled and hydraulically tested by a factory certified to ISO 9000 and 9001 standards.



Technical Data

Available Sizes (inch)

- Flanged - 1½, 2, 3, 4, 6, 8, 10, 12, 14 & 16"
- Grooved - 1½, 2, 3, 4, 6 & 8"
- Threaded - 1½ & 2"

Pressure Rating

- ANSI#150 - 16 bar / 235 psi
- ANSI#300 - 1½" to 10" 25 bar / 365 psi
12" to 16" 20 bar / 300 psi
- Grooved - 25 bar / 365 psi
- Threaded - 25 bar / 365 psi
- Setting range: 4 - 12 bar (60 - 175 psi)

Elastomer

- HTNR - Fabric Reinforced High Temperature Compound - See engineering data

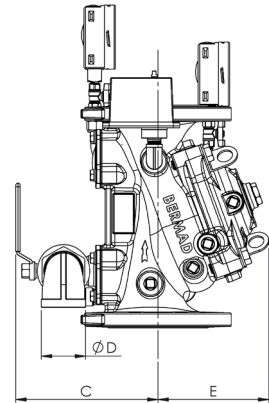
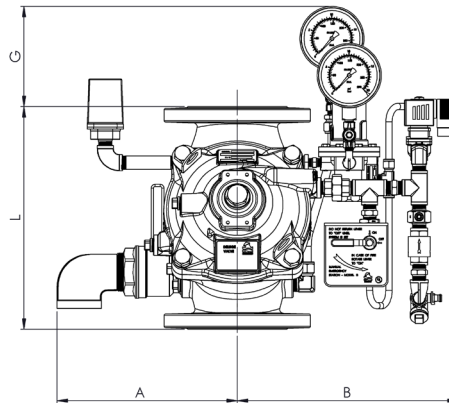

Valve Size	1½" DN40	2" DN50	3" DN80	4" DN100	6" DN150	8" DN200	10" DN250	12" DN300	14" DN350	16" DN400
⁽¹⁾ L ¹ ANSI #150 mm (in.)	230(9.06)	230(9.06)	310(12.21)	350(13.79)	480(18.91)	600(23.64)	730(28.76)	850(33.49)	980(38.61)	1100(43.34)
L ² ANSI #300 mm (in.)	230(9.06)	238(9.37)	326(12.84)	368(14.50)	506(19.94)	626(24.66)	730(28.76)	888(34.96)	980(38.61)	1100(43.34)
A mm (in.)	330(13.0)	330(13.0)	390(15.4)	398(15.7)	451(17.8)	481(18.9)	481(18.9)	594(23.4)	594(23.4)	594(23.4)
B mm (in.)	334(13.1)	334(13.1)	392(15.5)	402(15.8)	457(18)	485(19)	485(19)	598(23.5)	598(23.5)	598(23.5)
C mm (in.)	241(9.5)	241(9.5)	274(10.8)	290(11.4)	304(12.0)	320(12.6)	320(12.6)	383(15.1)	383(15.1)	408(16.1)
ØD (in.)	¾"	¾"	1½"	2"	2"	2"	2"	2"	2"	2"
E mm (in.)	120(4.7)	120(4.7)	146(5.7)	158(6.2)	228(9.0)	295(11.6)	295(11.6)	441(17.4)	441(17.4)	415(16.3)
F mm (in.)	179(7)	179(7)	109(4.3)	82(3.2)	0.5(0.01)	-	-	-	-	-
G mm (in.)	141(5.55)	141(5.55)	131(5.2)	118(4.6)	69.5(2.7)	45(1.8)	-	-	-	-
⁽⁴⁾ Kv m ³ /h (Cv gpm)	68(79)	80(92)	190(219)	345(398)	790(912)	1160(1340)	1355(1565)	2370(2737)	2850(3292)	3254(3758)
⁽²⁾ Leq m (ft)	2(7)	5(16)	7(23)	9(30)	15(49)	27(89)	62(203)	52(171)	59(194)	88(289)
Kg(lb) flanged#150/ISO16	18.3(40.3)	19.7(43.3)	34.4(75.7)	44.4(97.7)	87.7(193)	151(332.2)	181(398)	324(713)	357(785)	403(887)

Notes: ⁽¹⁾ L1 Dimensions are for grooved, threaded and raised face flanged valves

⁽²⁾ Leq (Equivalent Pipe Length) refers to a fully opened valve with turbulent flow in new steel pipe schedule 40, values given for general consideration only

⁽³⁾ Dimensions for the trim envelope may vary with specific component positioning

⁽⁴⁾ KV and Cv values are for a fully opened valve

Valve Code Designations

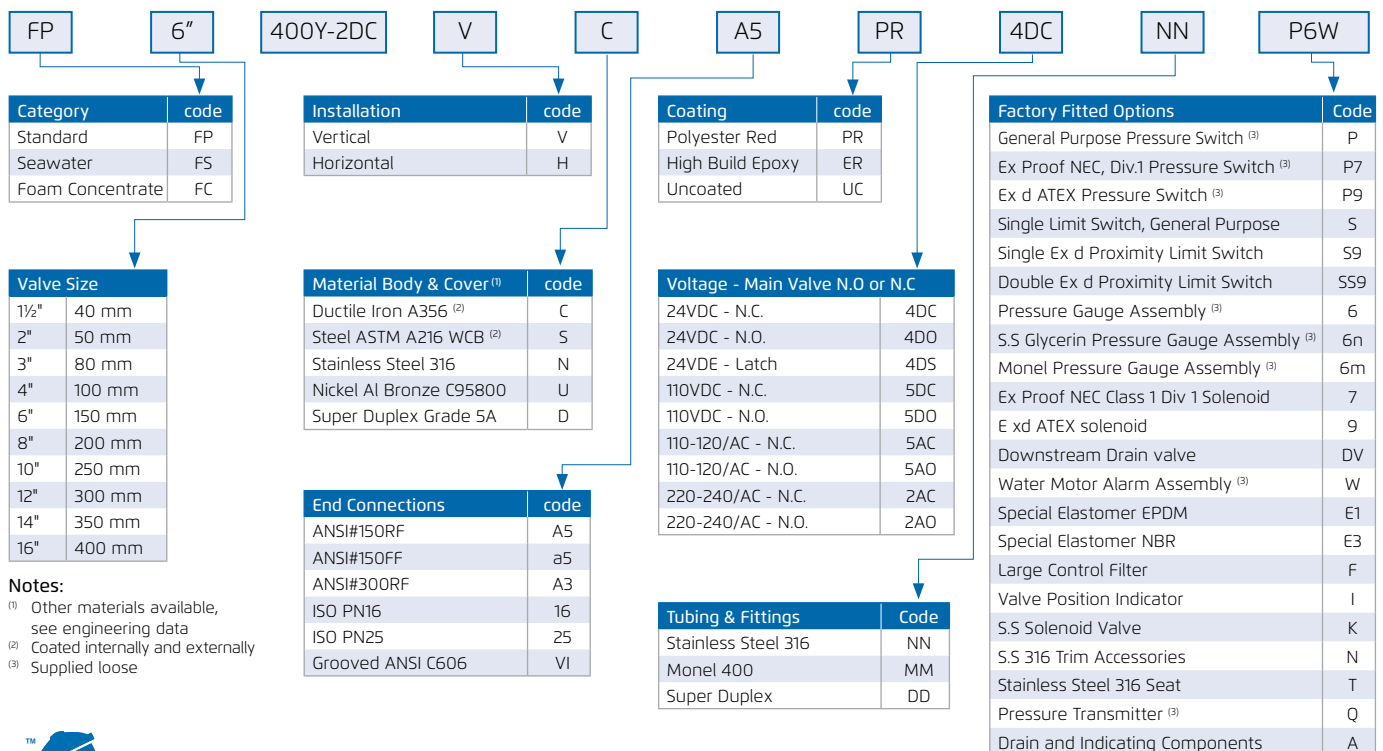

Notes:

- ⁽¹⁾ Other materials available, see engineering data
- ⁽²⁾ Coated internally and externally
- ⁽³⁾ Supplied loose

