

Pressure Reducing Valve

Model FP 720-UL

The Model FP 720-UL Pressure Reducing Valve reduces high, unstable upstream pressure to maintain precise stable downstream pressure, regardless of changing upstream pressure or flow, and requires only existing line pressure to operate.

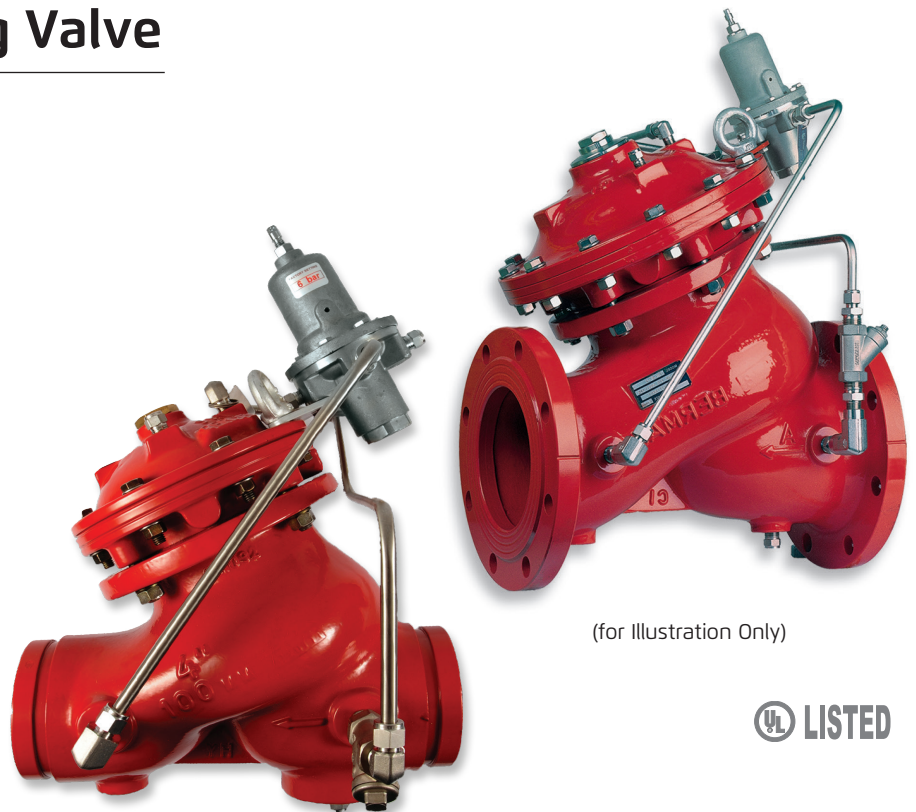

(for Illustration Only)



Features and Benefits

- **Advanced "Y" or angle pattern** - Efficient straight through flow
- **Broad operating flow range** - V-Port Throttling Plug
- **Advanced pilot system** - With integral adjustable closing speed
- **Accurately maintains dynamic and static pressure**
- **Double chambered unitized actuator** - Protected diaphragm and smooth operation
- **Easy, in-line inspection ensures minimal down time**
- **Quick and smooth valve action**
- **Replaceable stainless steel valve seat** – extended valve life

Optional Features

- **Large control filter (code: F)**
- **Seawater service FS as prefix to model**

Note: Optional features can be mixed and matched. Consult your BERMAD representative for full details.

Typical Applications



Hose station feeds

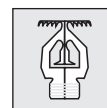

Sprinkler systems with overpressure

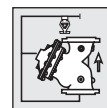

Deluge systems with overpressure

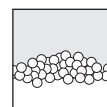

Foam systems



Fire hydrant water supply

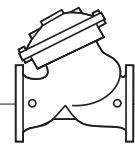

Operation

The BERMAD Model FP 720-UL, pressure reducing valve, pilot operated, automatically and accurately reduces downstream water pressure to a specific, adjustable value. The FP 720-UL operates under both flowing and non-flowing (static) conditions.

The Pressure Reducing Pilot [1] senses downstream pressure [2] and in real time modulates the main valve [3] to maintain a constant downstream pressure.

In no-flow static conditions, should the downstream pressure start rising above pilot setting, the pilot closes, shutting the main valve seal [4] drip-tight to maintain the allowable downstream pressure.

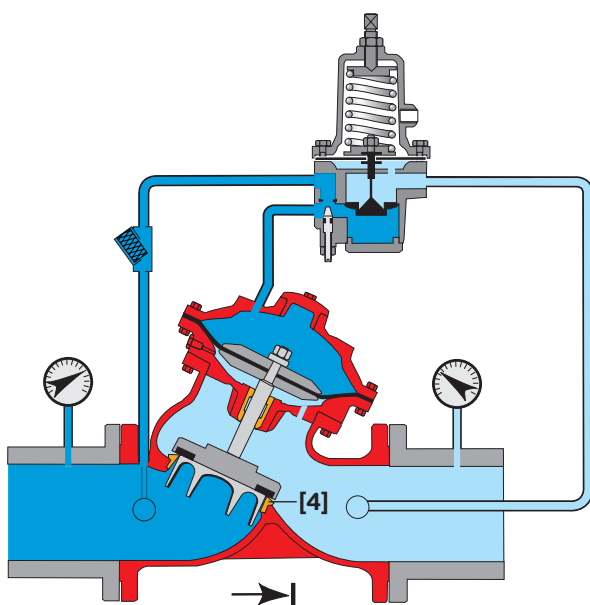

Valve Closed (static condition)

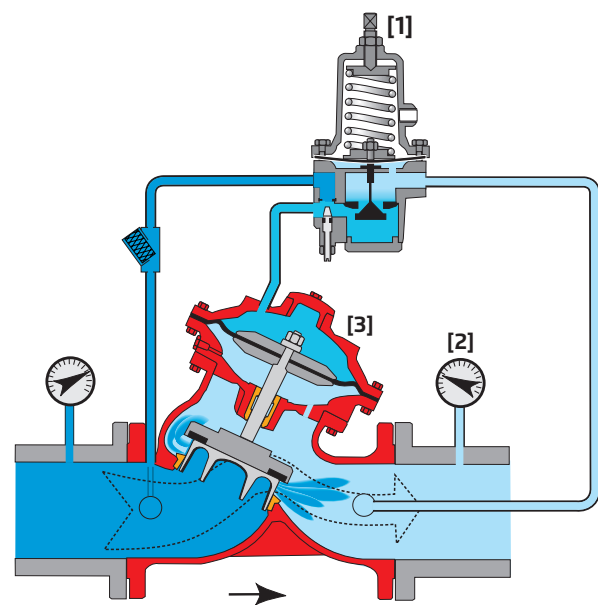

Valve Open (flowing condition)

Engineer Specifications

The Pressure Reducing Valve shall be UL Listed for fire protection.

The valve shall prevent downstream overpressure, maintaining a constant pre-determined downstream pressure regardless of varying upstream pressure or flow, including static or no-flow conditions.

The main valve shall be a diaphragm actuated, "Y" pattern (or angle) valve.

Valve actuation shall be accomplished by one moving assembly containing a double chambered actuator, which shall include a stainless steel stem and a resilient elastomeric seal held by a flat seal disk creating a drip tight seal against the seat.

The valve seat shall be removable and made of stainless steel. The seat bore net area shall be no less than that of the valve nominal diameter and shall have an unobstructed flow path with no stem guide or supporting ribs.

All necessary inspection and servicing shall be possible in-line.

The valve shall be UL-Listed as a pressure controlling water control valve.

The Pressure Reducing Pilot Valve shall be UL-Listed as part of the assembly.

The control trim shall be supplied as an assembly, pre-assembled and hydraulically tested at an ISO 9000 and 9001 certified factory.

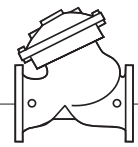

Typical Installations

Standard Pressure Reducing System

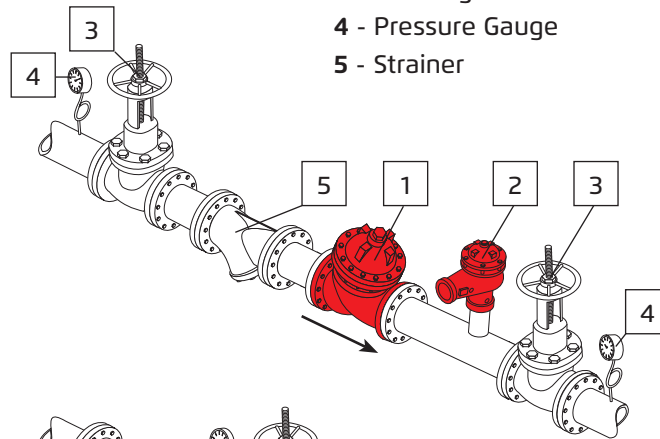

Parallel Pressure Reducing System

- Wide flow range
- Redundant safety
- Serviceable with zero down time

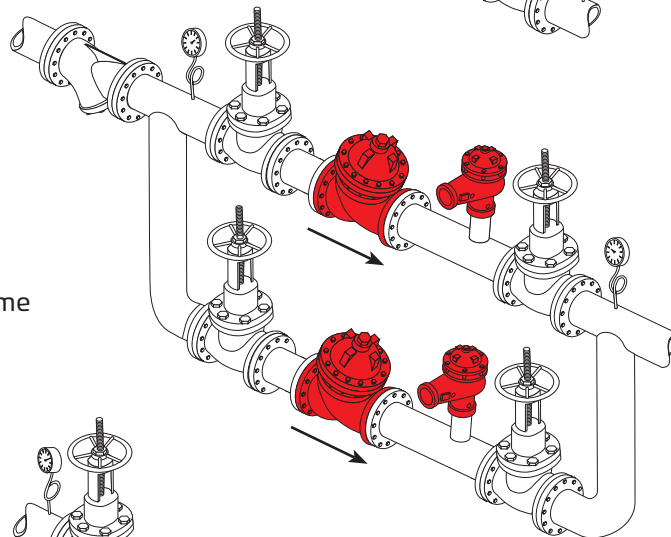

Two-Stage Pressure Reducing System

- High pressure differential
- Added reduced pressure zone protection

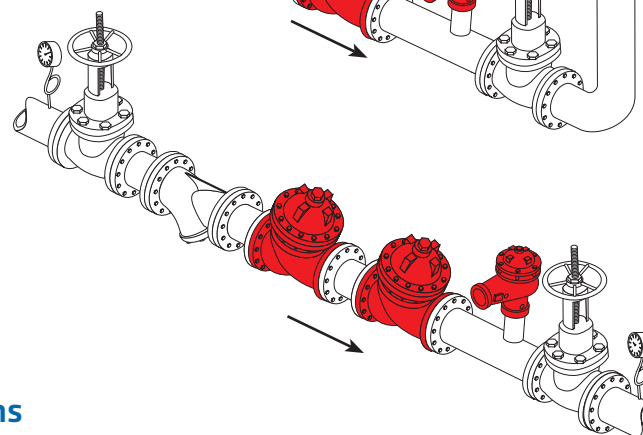

System Components

- 1 - BERMAD Model FP 720-UL
- 2 - Pressure Relief Valve (BERMAD Model FP 730-UF)
- 3 - Isolating Valve
- 4 - Pressure Gauge
- 5 - Strainer

Installation Considerations

- Allow enough room around the valve assembly for any future maintenance
- Install isolating valves upstream and downstream of the valve system
- Install the valve horizontally with the cover facing up
- Install a UL-Listed relief valve (recommended: BERMAD Model FP 730-UF) of the appropriate size on the downstream side of the FP 720-UL, as required by NFPA-20 standard
- Install a UL-Listed pressure gauge on both sides of the valve

The BERMAD Model FP 720-UL is UL-Listed when installed as a unit.

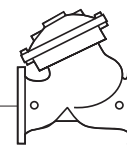

Technical Data

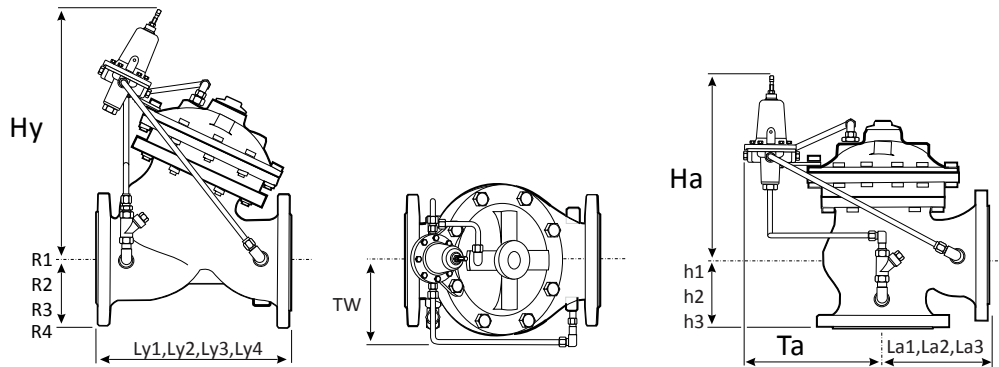

Size	1½"		2"		2½"		3"		4"		6"		8"		10"		12"		14"		16"		
	mm	inch	mm	inch	mm	inch	mm	inch	mm	inch	mm	inch	mm	inch	mm	inch	mm	inch	mm	inch	mm	inch	
Dimensions	Ly ₁	205	8.07	210	8.27	222	8.74	250	9.84	320	12.60	415	16.34	500	19.69	605	23.82	725	28.54	733	28.86	990	38.98
	Ly ₂	155	6.10	155	6.10	212	8.35	250	9.84	N/A	N/A	N/A	N/A	N/A	N/A	N/A	N/A	N/A	N/A	N/A	N/A	N/A	N/A
	Ly ₃	205	8.07	210	8.27	222	8.74	264	10.39	335	13.19	433	17.05	524	20.63	637	25.08	762	30.00	767	30.20	1024	40.31
	Ly ₄	205	8.07	210	8.27	215	8.46	250	9.84	320	12.60	415	16.34	500	19.69	N/A	N/A	N/A	N/A	N/A	N/A	N/A	N/A
	La ₁	124	4.88	124	4.88	148	5.82	152	5.98	190	7.48	225	8.86	265	10.43	320	12.60	396	15.59	400	15.75	450	17.72
	La ₂	121	4.75	121	4.75	140	5.50	159	6.26	N/A	N/A	N/A	N/A	N/A	N/A	N/A	N/A	N/A	N/A	N/A	N/A	N/A	N/A
	La ₃	124	4.88	124	4.88	149	5.86	159	6.26	200	7.87	234	9.21	277	10.91	336	13.23	415	16.34	419	16.50	467	18.39
	h ₁	85	3.35	85	3.35	109	4.29	102	4.02	127	5.00	152	5.98	203	7.99	219	8.62	275	10.83	279	10.98	369	14.53
	h ₂	83	3.25	83	3.25	102	4.00	115	4.53	N/A	N/A	N/A	N/A	N/A	N/A	N/A	N/A	N/A	N/A	N/A	N/A	N/A	N/A
	h ₃	85	3.35	85	3.35	109	4.29	109	4.29	135	5.31	165	6.50	216	8.50	235	9.26	294	11.57	299	11.77	386	15.20
	R ₁	78	3.05	83	3.25	95	3.74	100	3.94	112	4.39	143	5.63	172	6.77	204	8.03	242	9.51	268	10.53	300	11.81
	R ₂	38	1.48	40	1.57	48	1.88	56	2.20	N/A	N/A	N/A	N/A	N/A	N/A	N/A	N/A	N/A	N/A	N/A	N/A	N/A	N/A
	R ₃	78	3.05	83	3.25	93	3.64	105	4.13	127	5.00	159	6.26	191	7.50	223	8.76	261	10.26	295	11.61	325	12.80
	R ₄	33	1.30	40	1.56	40	1.56	57	2.24	70	2.76	95	3.74	125	4.92	N/A	N/A	N/A	N/A	N/A	N/A	N/A	N/A
	TW	155	6.10	155	6.10	155	6.10	170	6.69	180	7.09	200	7.87	236	9.29	281	11.05	316	12.43	316	12.43	410	16.14
Ta	182	7.16	182	7.16	182	7.17	200	7.88	216	8.48	274	10.79	308	12.13	351	13.80	383	15.08	383	15.08	473	18.62	
Hy	309	12.15	289	11.36	309	12.15	363	14.29	399	15.71	509	20.03	553	21.75	633	24.91	715	28.14	715	28.14	893	35.17	
Ha	246	9.69	246	9.69	246	9.69	282	11.10	311	12.22	349	13.72	387	15.22	448	17.62	505	19.87	505	19.87	632	24.89	

Notes:

- Ly₁ & R1 for ANSI#150, ISO PN16.
- La₁ & h₁ for Angle body, ANSI#150 and ISO PN16.
- Ly₂, R₂, La₂ & h₂ for threaded female, NPT or ISO-7-Rp.
- Ly₃, La₃, h₃ & R₃ for flanged ANSI #300 and ISO PN25.
- Ly₄ & R₄ for Grooved ends (see available sizes below).
- Data is for maximum envelope dimensions, component positioning may vary.
- Provide adequate space around valve for maintenance.

Connection Standard

- Grooved: ANSI/AWWA C606 for 2, 3, 4, 6 & 8"
- Flanged: ANSI B16.42 (Ductile Iron), B16.5 (Steel & Stainless Steel), B16.24 (Bronze), ISO PN16
- Threaded: NPT or ISO-7-Rp 2, 2½ & 3"

Water Temperature

- 0.5 - 80°C (33 - 180°F)

Sizes ("Y" & Angle)

- Available Y: 1½ - 20"
- Angle: 1½ - 18"
- 24-36" Globe
- UL-Listed: 2, 2½, 3, 4, 6 & 8"

Setting range

- 30 - 165 psi (2 - 11.5 bar)

Pressure Rating

- UL-Listed 2 - 6": 300 psi (21 bar)
8": 175 psi (12 bar)
- Flanged ANSI#150: 250 psi / 17 bar (code A5)
- Flanged ANSI#300: 400 psi / 28 bar (code A3)
- Flanged ISO 16: 235 psi / 16 bar (code 16)
- Flanged ISO 25: 350 / 24 bar (code 25)
- Grooved: 400 psi / 28 bar (code V2)
- Threaded NPT: 400 psi / 28 bar (code NH)
- Threaded ISO-7-Rp: 400 psi / 28 bar (code BH)

Manufacturers Standard Materials

Main valve body and cover

- Ductile Iron ASTM A-536

Main valve internals

- Stainless Steel & Elastomer

Control Trim System

- Brass control components/accessories
- Stainless Steel 316 tubing & fittings

Elastomers

- Polyamide fabric reinforced Polyisoprene, NR

Coating

- Electrostatic Powder Coating Polyester, Red (RAL 3002)

Optional Materials

Main valve body/internals

- Carbon Steel ASTM A-216-WCB
- Stainless Steel 316
- Ni-Al-Bronze ASTM B-148
- Titanium
- Duplex
- Hastalloy

Control Trim

- Stainless Steel 316
- Monel® and Al-Bronze
- Hastalloy C-276

Coating

- High Build Epoxy Fusion-Bonded with UV Protection, Anti-Corrosion

Approvals

- UL Listed for: Special system water control valves (VLMT), Pressure Reducing and Pressure Control type for Fire Protection Systems.
- ABS - Type Approved
- Lloyd's Register - Type Approved

