

Irrigation



BERMAD Irrigation

Hydraulic Control Valves

Water Control Solutions



Gilad Ben-Dror: Marketing concept and project management
Enav Waternets: Professional concept, text, and production management
Studio Oz: Graphic concept, design and production
Rami Levkovich: Technical consultant

irrigation

Irrigation for Agriculture

BERMAD Irrigation

Hydraulic Control Valves



BERMAD Irrigation

About this Catalog

BERMAD Catalog

This catalog presents a broad overview of the BERMAD main product lines for irrigation projects.

With irrigation representing its earliest challenge and serving as the springboard for development into other areas, BERMAD's irrigation products are the culmination of years of hands-on experience, while reflecting BERMAD's cumulative engineering and marketing savvy. Over the years BERMAD has expanded both its manufacturing and its R&D capabilities in order to meet every market need, resulting in the development and marketing of no less than twelve different product lines. In order to make it easier to choose the best possible product for each specific need, this catalog focuses on the 100, 400 & 900 Series product lines, presenting detailed and clear guidelines.

Unique in its approach the Catalog is organized from the viewpoint of the irrigation project designer, from the laterals to the water source. Products are subsequently divided into four main chapters based on the location of each system in the irrigation project:

- **Main Network** – This is the part of the project that pertains to the water source and includes major system components such as booster and deep well pump stations, reservoirs, main supply lines, pressure and flow control devices, etc.
- **Irrigation Control Head** – Here the water supply system is transformed to an Irrigation System. These Irrigation Centers include various types of large size control valves in a variety of applications.
- **Infield Head-Works** – Located on the Riser Lines at the entrance from the supply network to the distribution lines the Infield Head-Works serves as the system control of the water's final exit through the emitters. It includes various types of electric or hydraulic on/off remote control valves, which suit a variety of pressure and flow control applications.
- **Infield System** – These models are applied directly to the distribution lines of systems that require additional control such as systems irrigated by non-compensated emitters, systems with high elevation differential, systems with turbid water, sloppy margin systems, etc. Some of the most common components of Infield System are: Pressure Reducers, Anti-Drain Valves and Flush-'n-Stop Valves.

In addition the catalog also includes two more chapters:

- **Engineering** – A comprehensive technical section presents the updated relevant information about the BERMAD Series.
- **Accessories** – Presents full information about BERMAD's control accessories and system components.

The full range of control valves for the irrigation market is so extensive that we have confined ourselves in this catalog to a select number of models. Contact your BERMAD representative for information on additional models.

Despite our efforts to achieve perfection, if any errors have crept into the catalog, we would appreciate receiving your feedback.

All the Photos, Applications and Operation Drawings in this Catalog are for Illustration purpose.

The information herein is subject to change without notice.

BERMAD shall not be held liable for any errors contained herein. All rights reserved © Copyright by BERMAD

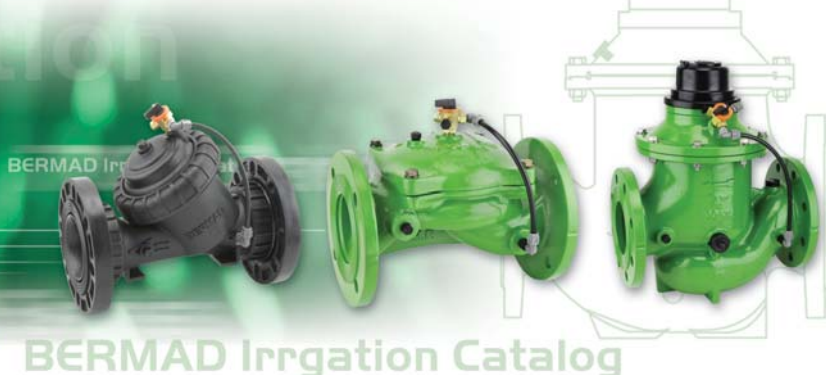

BERMAD Irrigation Catalog

BERMAD Company Profile

BERMAD Company Profile

Helping control the world's most precious resource

Efficient, smart management of our planet's most precious resources is as vital as the resource itself. BERMAD water management solutions offer nothing less.

Founded in 1965, BERMAD knows the value of a single drop of water and how best to reap its full advantage. Today BERMAD serves global customers in a wide range of fields. Bringing together its expertise and know-how, leading-edge technology and precision engineering, BERMAD provides comprehensive customized solutions for the control and management of water supply anywhere in the world.

BERMAD - Provider of Solutions

Based on expertise that comes from years of hands-on experience, BERMAD has developed state-of-the-art control valves and related products, along with comprehensive system solutions for a range of water management needs. Its main areas of activity include:

Irrigation

A comprehensive line of water control products provides system solutions for the full range of agricultural irrigation such as drip irrigation, pivot systems, sprinklers, micro-jets and greenhouse irrigation, as well as commercial and residential gardening irrigation needs.

Waterworks

BERMAD offers systems for water and wastewater supply and treatment facilities ranging from municipalities, high-rise buildings, to whole industrial water systems, hydroelectric power stations and private sector projects.

Fire Protection

Automatic control valves with a range of operation modes for fire protection systems in oil refineries, petro-chemical plants and public buildings.

Petroleum

Automatic, self-actuated control valves for the petroleum industry, implemented in distribution terminals, cross-country pipelines and petroleum tank farms.

Water metering

BERMAD solutions are adapted to the needs of bulk and domestic water metering in supply systems, and include remote water metering read-out and pre-payment systems.



BERMAD Company Profile

BERMAD – A Worldwide Presence

With 9 subsidiaries throughout the world, and operations in over 80 countries on 6 continents, BERMAD has a formidable global presence. Its worldwide customer training facilities and parts distribution networks ensure uninterrupted customer service. Making a significant contribution on the world arena, BERMAD has taken part in numerous major projects.



Irrigation Project References:



Italy - Carboj, Sicily

- Pumping “Arancio lake” water, supplying it to reservoirs on a mountain & irrigating 25000 Ha of various crops
- 6 units 18”-740, 4 units 8”-735, 1,000 units 3-8” hydrometers, and 20,000 units of various control valves
- BERMAD Italy, 1992



Italy - Iter, Sicily

- Infrastructure for new farming.
- 7,000 3” 310 valves with RTU, 2.8 M\$ for BERMAD valves and Motorola controllers
- One of the biggest projects in Sicily
- BERMAD Italy, 2002-2005



Spain - Aquifer 23 & 24

- Controlling 10,000 private farmers pumping from the same aquifer by hydrometers 927
- More then 1.7 M\$ through the years 1995-1998
- Uralita Tuberias De Systemas



Japan - Miyako

- Head works of small plots for vegetable private growers
- 2800 units 900-D AMV's, estimated total project - 750 K\$
- Government financed project
- E.S. Water Net, 2002-2003



Brazil - Fischer Cargill S.A

- Full irrigation system for 1377 hectare of citrus new plantation
- 24 units 6” pump control valves, and more then 200 units 3” PRV's
- Total project: 1.2 M\$ BERMAD part: 250 K\$,
- BERMAD Brazil & Irrigarplan, 2001-2002



Argentina - Rio Colorado

- Water carrier for irrigation
- 90 units 3”, 4”, 6” models 720, 727-55, 718-03, 73Q & 0710-03
- The biggest project in the province of Neuquen, Argentina
- Techint Skanska S.A.

BERMAD Company Profile



USA - Salt Water Intrusion / Irrigation Project, Monterey, California

- Artichoke and Strawberry irrigation
- 20 units 6" & 8" 772-55 controlling the head works of the farms
- BERMAD USA



China - Yangze River

- Irrigation of new plantation from the flood of the three gorges dam
- More than 250 valves 4"-8" 420, first phase of one of the biggest projects in the world
- BERMAD China & Netafim



Israel - Kolchey Eilat

- Treating, delivering (60 Km.), storing & pumping the city of Eilat wastewater for irrigation in the Negev desert
- 25 units 4-10" 720, 730 & 73Q, 10 units 4-8" 920 & 130 units 3x3-350
- 200 K\$
- AGAT Engineering, Ardom Association & BERMAD Israel



Palestinian Authority - Jericho

- Conversion from open canals flood irrigation to pressurized drip irrigation
- 250 units 927-DD installed on hydrants
- BERMAD Part - 250 K\$
- Italian finance, USA supervision
- Anera, 2003



Japan - Shizoka Prefecture

- Tee trees irrigation systems
- 2000 units 2" 220 valves + 500 units 2" 900-D
- Estimated total project - 500 K\$, government finance
- E.S. Water Net



Philippines - Mindanao Irrigation

- Banana plantation for Dole & Delmonte companies
- 120 units 4 - 6" 420 & 740
- Netafim



USA - Strawberry Farms, Salinas, California

- Strawberry farm, buried irrigation application
- 160 units 3"L 120-55 + 50 units 2" 220-55
- BERMAD USA



Argentina - Jujuy

- Water carrier for irrigation
- 12 units 14", 18" & 20" model 753-67-49
- Tecnoflow S.A.



USA - Nut Tree Farming

- Almond trees, Buried irrigation application
- More than 5,000 units 2" 220 Through the years 1995 to 2005
- BERMAD USA



Israel - Hof Karmel

- Water desalination for Irrigation through a reservoir with pump station
- 10 units 6-12" 750/720/730 + 50 un. 4-8" AMV's + 300 2" AMV's, BERMAD Part -More than 250 K\$
- BERMAD & Netafim



USA - Nut Tree Farming

- Almond Trees, buried Irrigation application
- 260 units 3"L 120 valves, first phase of a farm in Bakersfield CA
- BERMAD USA

BERMAD Irrigation

User Guide



Main Network

- Reservoirs
- Pumping Stations
- Pressure Reducing
- Pressure Relief
- Pressure Relief/Sustaining

Irrigation Control Head

- On/Off Control
- Pressure Reducing
- Pressure Relief
- Flow Control
- Pressure Sustaining
- Filter Stations

Infield Head-Works

- On/Off Control
- Pressure Reducing, Standard
- Pressure Reducing, Drip-Tape
- Pressure Reducing & Sustaining
- Pressure Sustaining
- Flow Control
- Flow Control & Pressure Reducing

Infield System

- Pressure Reducing
- Anti-Drain
- Flush-'n-Stop

Table of Contents

Group	Page No.
BERMAD Model Selection Guide	page 1-4
IR-400 Valve Data	page 5
IR-100 hYflow Valve Data	page 6
IR-900-M Hydrometer Data	page 7
IR-900-D Automatic Metering Valve Data	page 8
WW-700 Double Chamber Valve Data	page 9
Main Network	page 10
Main Network Application Guide	page 11-12
Level Control Valves	page 13-14
Pumping Station Valves	page 15-16
Pressure Reducing Valves	page 17-20
Pressure Relief Valves	page 21-22
Pressure Sustaining Valves	page 23-24
Irrigation Control Head	page 26
Irrigation Control Head Application Guide	page 27-28
On/Off Control Valves	page 29-32
Pressure Reducing Control Valves	page 33-36
Pressure Reducing & Sustaining Control Valves	page 37-40
Pressure Relief Valves	page 41-42
Flow Control Valves	page 43-46
Pressure Sustaining Control Valves	page 47-50
Filter Station Control Valves	page 51-54
Infield Head-Works	page 56
Infield Head-Works Application Guide	page 57-58
On/Off Control Valves	page 59-62
Pressure Reducing Control Valves for Standard Systems	page 63-66
Pressure Reducing Control Valves for Drip-Tape Applications	page 67-70
Pressure Reducing & Sustaining Control Valves	page 71-74
Pressure Sustaining Control Valves	page 75-78
Flow Control Valves	page 79-82
Flow Control & Pressure Reducing Valves	page 83-86

BERMAD Irrigation

Group	Page No.
Infield Systems	page 88
Infield Systems Application Guide	page 89-90
Pressure Reducing for Infield Systems	page 91-94
Anti-Drain Valves	page 95
Flush-'n-Stop Valves	page 96
Engineering Data	page 98-99
IR-400 Series Engineering Data	page 100-109
IR-100 Series Engineering Data	page 110-116
IR-900-M Series Engineering Data	page 117-130
IR-900-D Series Engineering Data	page 131-140
WW-700 Series Engineering Data	page 141-152
Water Meters Engineering Data	page 153-158
IR-350 Series Engineering Data	page 159-163
IR-200 Series Engineering Data	page 164-168
IR-300 Series Engineering Data	page 169-172
IR-R00 Series Engineering Data	page 173-176
PRV Series Engineering Data	page 177-181
AR Series Engineering Data	page 182-186
Accessories	page 188
Mini-Pilots	page 190-191
Pilots	page 192-195
Solenoids	page 196-198
Latching Solenoids	page 199-200
Accessories & Components	page 201-204
System Components	page 205-207

- Pictures and drawings are for presentation only
- Bermad reserves the right to make any product changes without prior notice
- For further details please see our Comprehensive Irrigation Catalog
- Special technical documentation must be requested separately

BERMAD Model Selection Guide

Over the years BERMAD has expanded its manufacturing together with its R&D capabilities to meet each and every market need and customer desire, developing and marketing no less than nine different product lines. Today BERMAD customers can find a solution for every problem or application among the endless variety of patterns, diameters, pressure ratings, construction materials, and application options that BERMAD introduces in to the market. In fact, the only problem one might have is in selecting the very best option for each specific need from technical abilities, to reliability and service, environmental suitability, and cost efficiency.

By focusing on the IR-100, IR-400, IR-900 & WW-700 Series this Catalog represents BERMAD's efforts to make the selection of optimal solutions clearer and simpler for our customers.

One of the most frequently asked questions about irrigation valves is when to use each valve series and how to make the correct selection. Here are some helpful hints.

400 Series – Consider using when the ultimate in valve regulation is required and when:

- Applying metal valves in main line control where long term reliability is essential
- Low flow stable regulation at high differential pressure is required
- Systems pressure is higher and the valve may be subject to water hammer conditions
- Maintenance must be quick and simple
- Required valve diameter exceeds 10"; DN250

100 Series – Consider using when high flow & low pressure loss is required and when:

- Reinforced plastic valves are recommended for:
 - High chemical and cavitation resistance
 - Light weight valves which are frequently moved in crop rotation
 - Ease of installation of large projects for labor in the field
- Extreme regulating applications are expected such as low pressure drip-tape applications
- Supply pressures are limited, energy saving is a must and high flows are required
- Maintenance simplicity is desired
- Flexibility of end connection is an advantage in the installation of the valve
- Valves are exposed to pipeline bending and pressure stresses

900 Series – Consider using when metering and flow rate reading is required and when:

- An "All-in-One" water meter and control valve is an advantage, saving installation space, cost and maintenance
- Pressure and/or flow control regulation should be combined with accurate flow readout and transmission
- Straightening distances represent a problem
- Transfer systems simultaneously measure and control bulk water
- Batching and/or sequential non-computerized control is required

700 Series – Consider using when high performance, double chamber, industrial valve is required and when:

- Required pressure rating exceeds 16 bar; 230 psi
- Active check valves and surge anticipating valves for pumping stations are required
- System design requires down-hill serial pressure reduction or preliminary reduction for high ΔP
- Extreme regulating applications are required
- Reliable function under near-zero line pressure is needed
- Exotic metals and Elastomers are defined for aggressive water applications

Please refer to the tables on the next page, to help you determine the most suitable valve series for your specific needs. Complete technical details can be found in the Engineering section.

BERMAD Irrigation

Valves Flow Data Table

$$\Delta P \text{ bar} = [Q \text{ (m}^3\text{/h)} / K_v]^2; \Delta P \text{ psi} = [Q \text{ (gpm)} / C_v]^2$$

Valve Size		Recommended Flow Range V= 1.5-5 m/s; 5-17 f/s		Momentary Peak Relief Flow	Valve Flow Coefficient							
					400		100		900		700	
mm	inch	m ³ /h	gpm		Kv	Cv	Kv	Cv	Kv	Cv	Kv	Cv
40	1½	6-21	28-94	WW-700 Series V=15 m/s; 50 f/s	N.A.		N.A.		41	47	45	49
50	2	11-36	49-166		57	66	100	115	46	53	50	58
65	2½	17-57	76-260		78	90	100	115	51	59	55	64
80R	3R	17-57	76-260	IR-100 Series V=12 m/s; 40 f/s	N.A.		N.A.		50	58	N.A.	
80	3	25-82	110-375		136	157	100	115	115	133	115	133
80L	3L	44-146	196-665		N.A.		200	230	N.A.		N.A.	
100	4	44-146	196-665	IR-400 Series V=10 m/s; 33 f/s	204	236	200	230	147	170	200	230
150	6	98-328	440-1,498		458	529	400	460	430	497	460	530
200	8	175-584	783-2,663		781	902	N.A.		550	636	815	940
250	10	274-912	1,224-4,160		829	957	N.A.		550	636	1250	1440
300	12	394-1,313	1,762-5,990		1932	2231	N.A.		N.A.		1850	2140
350	14	394-1,313	1,762-5,990		1932	2231	N.A.		N.A.		1990	2300
400	16	700-2,335	3,130-10,650		1932	2231	N.A.		N.A.		3310	3820
450	18	700-2,335	3,130-10,650		N.A.		N.A.		N.A.		3430	3960
500	20	700-2,335	3,130-10,650		N.A.		N.A.		N.A.		3550	4100
600	24	1,575-2,250	7,050-23,970		N.A.		N.A.		N.A.		7350	8490
700	30	1,575-2,250	7,050-23,970	N.A.		N.A.		N.A.		7500	8670	
800	32	1,575-2,250	7,050-23,970	N.A.		N.A.		N.A.		7500	8670	

Allowable minimum and maximum flow rates depend on numerous system details such as:
Upstream pressures, set pressures, control circuit, system layout and influences of other system components.

As a "Thumb-Rule" for valve sizing please note:

- Recommended flow velocity for On/Off Valves is 1.5 m/s; 5 f/s
- Recommended flow velocity for Regulating Valves is 3 m/s; 11 f/s
- Valve head loss can be calculated according to the ΔP equation at the top of the Table.

Complete Technical details can be found in the Engineering section.

Valves Series Selection Table

Selection Parameter	IR-400 Series	IR-100 Series	IR-900 Series	WW-700 Series
Size Range	¾-16"; DN20-400	2-6"; DN50-150	1½-10"; DN40-250	1½-32"; DN40-800
Valve Body Optional Patterns*	G; A	Y; A	G; A; H	Y; G; A
Construction Materials	Coated Iron or Ductile Iron	Glass-Filled Nylon	Coated Iron or Ductile Iron	Coated Ductile Iron
Pressure Ratings	16 bar; 232 psi	10 bar; 145 psi	16 bar; 232 psi	PN16: 16 bar; #150: 250 psi PN25: 25 bar; #300: 400 psi
Flow Metering Abilities	No	No	Yes	No
Double Chamber Actuator	No	No	No	Yes
Maintenance Required Skill	Basic	Basic	High	Medium

* G = Globe, A = Angle 90°, H= Hydrant (Angle 120°) Y= Oblique Globe

Note:

Marks are for comparison purpose.

Valve Control Features:

After selecting the proper valve series, one can choose from over 200 valve models, the desired model according to valve location in the project and its required application as defined by its control features.

1. Main Feature/s – Selection of the suitable model requires proper definition of the valve main control feature or features:

- Pressure Reducing
- Pressure Sustaining
- Flow Control
- Solenoid Control
- Combination of the above, etc.

These features and others, enable the control valve to meet and answer system needs at a specific location.

2. Additional Feature/s – Proper definition of additional control features enables utilization of the control valve's potential to the fullest, in the following ways:

- Add-on of automatic functions that support and complete the valve main feature:
 - Downstream over-pressure guard
 - Closing-surge prevention
 - Check feature
 - Hydraulic override, etc.
- Determining valve status in the project control system, according to needs and control type, as well as environmental calculations and expected skill level of maintenance personnel.
 - Manual/Hydraulic/Electric - Opening/Closing control
 - Valve's desired normal position
 - Float type definition for level control valves, etc.

2.1 Valve Remote Control Features

N.O. Hydraulic Control:.....	50
N.C. Hydraulic Control:.....	54
Electric Control:	55

For Solenoid Control Confirm:

- Desired voltage and valve's normal position
- Controller abilities & requirements
- Lightning probability

Calculate wire size in accordance with:

- System pressure conditions
- Solenoid's power consumption, quantity & distance

Remote Control Options Comparison Table

Feature	Parameter	Simplicity	Fail-Safe	Plots with Slope	Remote Valves	Multiple Valves	Valve Response
	50	++++	Open	+	++	++	Delayed
	54	+++	Close	+++	++++	++++	Immediate
	55	+++	Close	++++	++++	++++	Immediate

BERMAD Irrigation

Valve Control Circuit:

After defining the valve control features, the applications designer must select the suitable control circuit type (2-Way, 3-Way, 2/3-Way servo) for the application, considering network hydraulic and topographic conditions, water quality, required accuracy and sensitivity levels, etc.

Consider the information below as a guide when selecting the control circuit type:

■ 2-Way Control

Use when very accurate control is required in clean filtered water supply or dirty water with sediments. Works well in dynamic or static flow condition. Note that applying a 2-way control circuit has a small additional head loss across the valve in low and medium flow-rates ("V" below 2 m/s).

■ 3-Way Control (mark = X)

Use in applications where the water qualities can either be clean or dirty which includes some organic matter. 3-way control will enable the valve to fully open if required during high flow irrigation shifts; when the valve is required to fully open with minimal head loss.

■ Servo 3/2-Way Control (mark = b)

Use in applications where the water qualities can either be clean or dirty with sediments or organic matter. The Servo 3/2-way pilot should be considered where extreme accuracy and regulation ability is required together with the possibility of dirty water. Especially recommended for pressure reduction of low pressure Drip-Tape (non compensated) irrigation systems.

Control Circuit Comparison:

2-Way Control Circuit **Default**

- Online accurate, quick respond regulation
- Very low set point
- Very high accuracy

3-Way Control Circuit **X**

- Fully opens at low supply pressure
- Easy conversion from/to 2/3-way

2/3-Way Control Circuit **b**

- Very low set point
- Very high accuracy
- Dynamic integrated needle valve
- Upstream Setting pressure limit – 4 bar; 60 psi

Control Circuit Options Comparison Table

Circuit \ Parameter	Sensitivity	Accuracy	Stability	Minimum Setting	Clogging Risk		External Bleed
					Sediments	Organic Matter	
2-Way	++++	+++	+++	Very Low	Low	Medium	No
3-Way	++	++	++++	Low	Fair	Low	Yes
2/3-Way	++++	++++	++++	0.5bar; 7psi	Low	Low	No



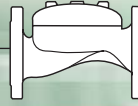

IR-400 Basic Valve

The basic Model IR-400 diaphragm actuated hydraulically operated valve is at the leading edge of control valve design. It combines simple and reliable construction with superior performance, while at the same time being virtually free of the typical limitations associated with other single chambered valves. These automatic water control valves are designed for vertical or horizontal installation and are available in diameter sizes of 2-16"; DN50- DN400, in a wide range of materials and end connections.

The design of the IR-400 valve body includes a full bore seat with unobstructed flow path, free of any in-line ribs, supporting cage, or shafts.

The unique hydro-dynamic globe design provides high flow capabilities with minimum head loss. The cover is removable via four (4) fastening bolts (up to 10") for quick in-line inspection and service. The internal design of the IR-400 valve is based on innovative technology using advanced rubber-based materials to achieve a solid, one piece elastomeric assembly including a flexible fabric reinforced diaphragm, vulcanized with a rugged radial seal disk. The diaphragm is carefully balanced and peripherally supported to avoid distortion and to protect the elastomer, resulting in long-life and controlled actuation even under harsh conditions. One diaphragm and spring fully meet the valve's operating pressure range requirements. The diaphragm assembly can be easily removed from the valve body with no need for disassembling the valve from the line.

The Model IR-400 Basic Valve uses valve differential pressure to power the diaphragm assembly open or closed. The lower side of the diaphragm, which serves to cushion the closing of the valve, is exposed to downstream pressure through a dynamic peripheral passageway that its width responds to differential pressure and flow along the downstream side of the valve. The pressure in the control chamber varies, usually resulting from the combined action of a regulating pilot and a fixed orifice. This varying pressure modulates the valve to open or close.



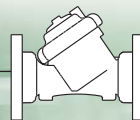

IR-100 hYflow Basic Valve

The BERMAD basic Model IR-100 hYflow diaphragm actuated, hydraulically operated valve is at the leading edge of control valve design. It combines simple and reliable construction with superior performance, while at the same time being virtually free of the typical limitations associated with standard control valves.

BERMAD's automatic water control valves are designed for vertical or horizontal installation and are available in sizes of 2", 2½", 3", 4" & 6"; DN: 50, 65, 80, 100 & 150.

The Model IR-100 hYflow, made from industrial durable glass-filled nylon, is engineered to meet rough service conditions with high chemical and cavitation resistance.

The hYflow 'Y' valve body design includes a full bore seat with unobstructed flow path, free of any in-line ribs, supporting cage, or shafts.

Its unitized Flexible Super Travel (FST) diaphragm and guided plug provide a significantly 'look through' passage from end to end resulting in ultra-high flow capacity with minimal pressure loss. The combination of a long travel guided valve plug, peripherally supported diaphragm, and replaceable valve seal provides:

- No chattering or slamming closed
- Accurate and stable regulation with smooth motion
- Low operating pressure requirements
- No diaphragm erosion and distortion
- Diaphragm and spring fully meet the valve's operating pressure range requirements.

Designed for service under a wide range of pressure and flow conditions, from dripping to maximum flow, the IR-100 hYflow excels at being a user-friendly control valve:

- Simple design with few parts guarantees easy in-line inspection and service.
- Adaptable on-site to a wide range of end connection types and sizes.
- Articulated flange connections isolate the valve from pipeline bending and pressure stresses.



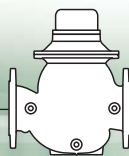

IR-900-M Basic Valve

Hydrometer with Magnetic Drive

The BERMAD Model IR-900-M is a unique product integrating both a vertical turbine Woltman-type water meter and a diaphragm actuated hydraulic control valve. The vertical turbine impeller drive is magnetically coupled to a vacuum-sealed meter register in the control head. Both the magnetic drive control head and its register(s) are hermetically sealed and are not affected by dirty water nor environmental humidity.

The highly sensitive magnetic drive provides superior accuracy that exceeds all water meter standards. The available Reed Switch and Opto-Electric 4-20 mA transmitter options provide greater flexibility in electrical pulse generation.

Serving as Flow Meter and Main Valve, the BERMAD Model IR-900-M controls irrigation together with the irrigation controller.

The IR-900-M provides the full spectrum of metering functions – from simple visual readout, to pulse output for computerized data capture and control – while simultaneously allowing for numerous control valve features such as pressure, level and flow control.

Ranging in size from 1½"; DN40 through 10"; DN250, the 900-M Series is specifically designed for metering and control applications in agricultural and landscape irrigation as well as in municipal & industrial water supply systems.

The flow metering unit is vertical to the pipeline and includes an impeller with integrated inlet and outlet flow straighteners. This internal design eliminates the need for straightening distances, enables vertical or horizontal installation, and ensures accuracy even when the valve is partially open during pressure or flow control tasks. The impeller assembly shaft serves as the closure assembly guide, while also centralizing and tightening all internal parts both in their position and to one another.

The basic Model IR-900-M combines simple and reliable construction with superior performance, while at the same time being virtually free of the typical limitations associated with other single chambered valves. The relatively high impeller housing raises the location of the vulcanized seal seat above the valve body. This results in remarkable cavitation resistance and a smooth mushroom-shaped flow where the valve body is distanced from the flow.

The closure assembly, combining a rugged radial disk harnessed to a flexible fiber reinforced diaphragm, slides on the guide along the full valve travel. The diaphragm is carefully balanced and peripherally supported to avoid distortion, resulting in long-life and controlled actuation even under harsh conditions. One diaphragm and spring fully meets the valve's operating pressure range requirements. The cover is removable via fastening bolts for quick in-line inspection and service. All the internal assemblies can be easily removed from the valve body with no need for disassembling the valve from the line.



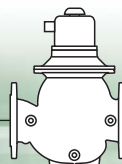

IR-900-D Basic Valve

Automatic Metering Valve (AMV)

The BERMAD Model IR-900-D is a unique product integrating both a vertical turbine Woltman-type water meter and a pilot operated, diaphragm actuated control valve, with a built-in auxiliary shut-off pilot for batch applications. When this unique assembly delivers a preset quantity of water, its control head mechanism mechanically shifts the shut-off pilot. This automatically and smoothly closes the control valve, stopping the flow of water.

The IR-900-D provides the full spectrum of metering functions - from simple visual readout, through non-computerized dose control, to pulse output for computerized data capture and control - while simultaneously allowing for numerous control valve features such as pressure, level and flow control.

Ranging in size from 1½"; DN40 through 10"; DN250, the 900-D Series is specifically designed for metering and control applications in agricultural and landscape irrigation as well as municipal and industrial water supply systems.

The flow metering unit is vertical to the pipeline and includes an impeller with integrated inlet and outlet flow straighteners. This internal design eliminates the need for straightening distances, enables vertical or horizontal installation, and ensures accuracy even when the valve is partially open during pressure or flow control tasks.

The impeller assembly shaft serves as the closure assembly guide, and for centralizing and tightening all internal parts both in their position and to one another.

The basic Model IR-900-D combines simple and reliable construction with superior performance, while at the same time being virtually free of the typical limitations associated with other single chambered valves. The relatively high impeller housing raises the location of the vulcanized seal seat above the valve body. This results in remarkable cavitation resistance and a smooth mushroom-shaped flow where the valve body is at maximum distance from the flow.

The closure assembly, combining a rugged radial disk harnessed to a flexible fiber reinforced diaphragm, slides on the guide along the full valve travel. The diaphragm is carefully balanced and peripherally supported to avoid distortion, resulting in long-life and controlled actuation even under harsh conditions. One diaphragm and spring fully meets the valve's operating pressure range requirements.

The cover is removable via fastening bolts for quick in-line inspection and service. All the internal assemblies can be easily removed from the valve body with no need for disassembling the valve from the line.



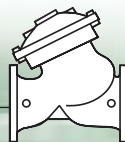

WW-700 Basic Valve

The basic Model WW-700/705 diaphragm actuated and the WW-800/805 piston-actuated valves are hydraulically operated, globe valves in either the standard oblique (Y) or angle pattern design. Each valve comprises two major components: the body-seat assembly and the actuator assembly.

The actuator assembly is unitized and is removable from the body as an integral unit. It consists of both an upper and a lower control-chamber.

Each basic valve can easily be configured, on-site, either as a single chamber control valve (Model 705/805), or a double chamber control valve (Model WW-700/800). The shaft sub assembly, in both single and double chambered versions is center guided, providing an unobstructed seat area.

The Model WW-700/800 Basic double chambered valve operation is independent of valve differential pressure since the line pressure actually serves as the actuator differential pressure. This develops maximum power, ensuring immediate valve response. The upper control chamber is pressurized to close, and vented to open the valve. The lower control chamber is usually vented to the atmosphere, but can also be pressurized to power the valve open.

The Model WW-705/805 Basic Valve uses valve differential pressure to power the actuator open or closed. The lower control-chamber, which serves to cushion the closing of the valve, is exposed to the downstream pressure, through a fixed orifice connected to the downstream side of the valve. The pressure in the upper control-chamber varies, usually resulting from the combined action of a regulating pilot and a fixed orifice. This varying pressure modulates the valve to open or close.

The Basic Hydraulic Valve is available in a wide range of materials, sizes, pressure ratings, and end connections. Single or double chambered versions are used as the main valve in all WW-700 and WW-800 Series applications.



Irrigation for Agriculture

Main Network

Irrigation system **Main Network** design and operation starts with careful examination of the available water sources and the physical conditions of the project regarding expected flow, pressure, and quality ranges. Based on these parameters, the project engineer determines the type, size and location of major system components including pump stations, reservoirs, supply lines, pressure control devices, air release, filtration, and so on.

These components are then integrated into the **Main Network** to achieve continuous, reliable, efficient, and cost-effective irrigation.



BERMAD Irrigation

Main Network



Reservoir



Level Control System



Pumping Station



Pressure Reducing System



Main Line

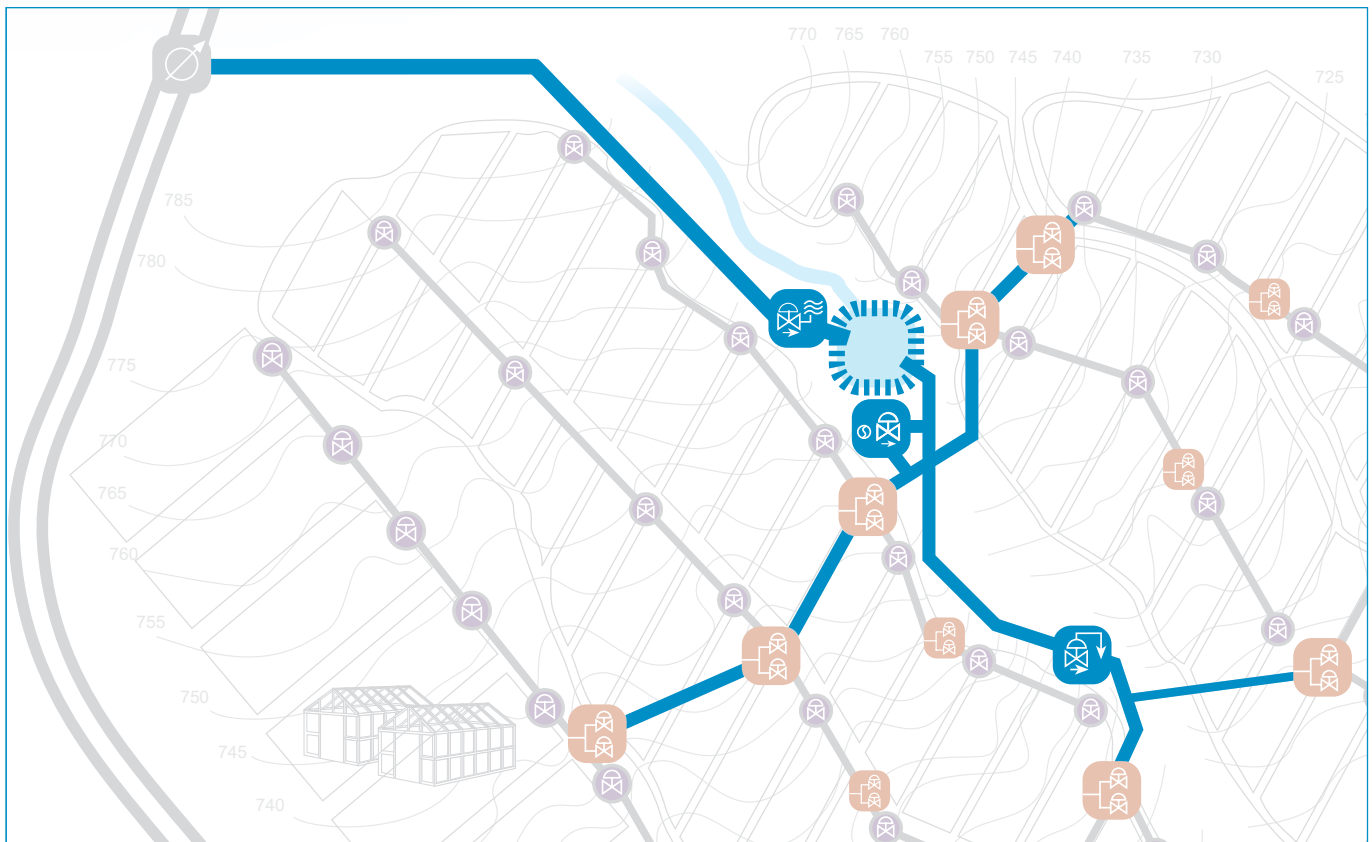
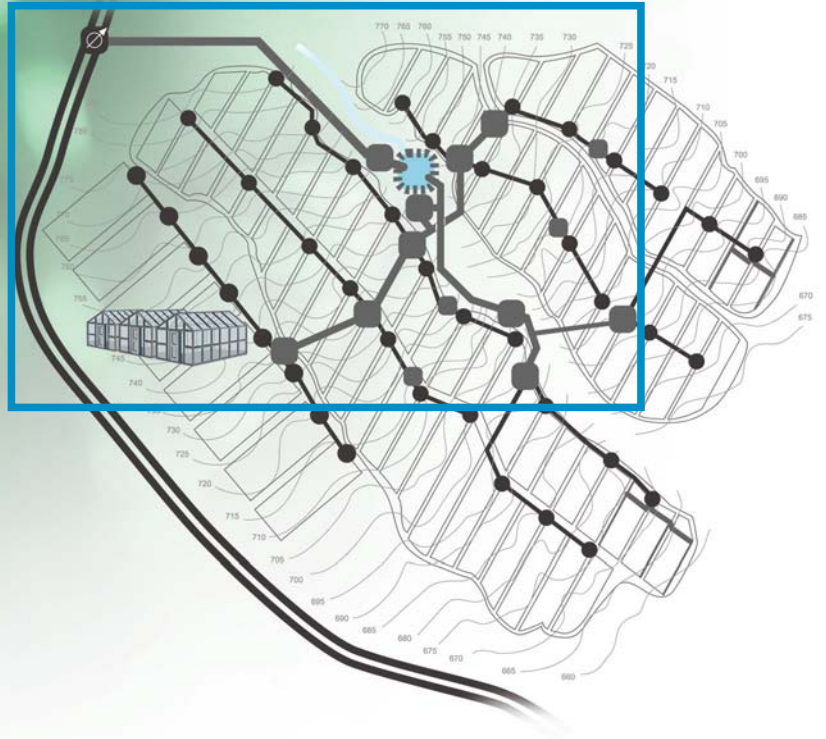

Reservoirs



Pumping Stations

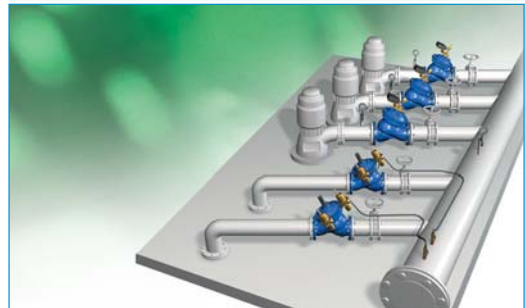

Pressure Reducing



Pressure Relief

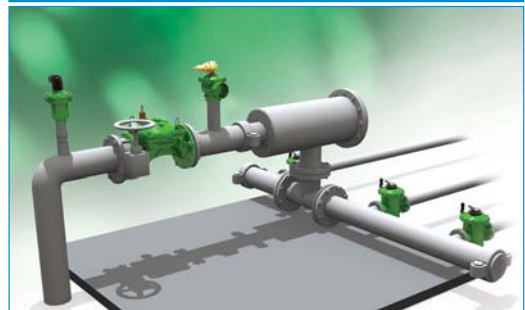

Pressure Relief/Sustaining



Level Control Valves

Level Control Valves combine the advantages of excellent hydraulic control valves with the simplicity of altitude pilots or mechanical floats. External installation of the main valve eliminates installation and maintenance problems associated with mechanical float valves installed in the reservoir. A wide selection of altitude and float pilot types makes BERMAD Float Control Valves the right solution wherever level control is required.



Applications Guide

- Full Range of Low Level Reservoirs
- Unavailable Power Supply Locations
- Very Low Supply Pressure Systems
- Energy Cost-Critical Systems
- Fertilizer Mixing Tanks (IR-450-60)
- High Level Reservoirs and Water Towers (IR-450-80)
- Level Sustaining at Reservoir Outlet (IR-453)
- Limited Supply Pressure Systems (IR-453)
- Systems Irrigated Directly from Fill-Up Line (IR-453 & IR-457)
- Backup for Reservoir Supply Valves (IR-453 & IR-457)
- Limited Flow Capacity Systems (IR-457)
- Reservoirs Subject to High Inlet Pressure (IR-457)
- Pressure Breaking Reservoirs in Gravity Fed Lines (IR-457)



Level Control BERMAD Valve with Modulating Horizontal Float

IR-450-60-R

The BERMAD Level Control Valve with Modulating Horizontal Float hydraulically controls reservoir filling, to maintain constant water level for “Always Full” reservoir applications such as: large surface area reservoirs, low volume reservoirs, and fertilizer mixing tanks.



Level Control BERMAD Valve with Bi-Level Vertical Float

IR-450-66-Z

WW-750-66-B

The BERMAD Level Control Valve with Bi-Level Vertical Float is hydraulically controlled to fully open at the preset reservoir low level and to shut at preset high level. It provides On/Off service with long life operation and is suitable for controlling the full range of low level reservoirs even when power supply is unavailable.



Level Control BERMAD Valve with Altitude Pilot

IR-450-80-XZ

WW-750-80-X

The BERMAD Level Control Valve with Altitude Pilot hydraulically shuts at the preset reservoir high level and fully opens in response to an approximately one-meter (three-foot) level drop, as sensed by the 3-way altitude pilot mounted on the main valve. It does not require float installation, and it provides On/Off service with long life operation. The valve is suitable for controlling reservoir level while filling, or for sustaining water level at reservoir outlet for the full range of high level reservoirs and water towers.



Level Control & Pressure Sustaining BERMAD Valve with Bi-Level Vertical Float

IR-453-66

Level & Flow Control BERMAD Valve with Bi-Level Vertical Float

IR-457-66-U

IR-453-66

IR-457-66-U

The BERMAD Models IR-453-66 and IR-457-66-U, hydraulically control reservoir filling. They open at the preset reservoir low level, and shut at preset high level. During filling, they sustain system minimum upstream pressure (IR-453-66), or limit fill-up flow to a maximum preset value (IR-457-66-U). The valves are suitable for controlling the full range of low level reservoirs, especially in systems irrigated directly from fill-up line, systems with limited supply pressure or flow capacity, and pressure braking reservoirs in gravity fed lines or other reservoirs subject to high inlet pressure.

The BERMAD Models IR-453-66 and IR-457-66-U can also serve as backup for standard reservoir valves.

Pumping Station Valves

Pump Control Valves protect pumps, pipelines, and other system components by isolating the pipeline from the sudden velocity changes associated with pump start-up and stopping. The “Active Check Valve” operating logic, employs a method of operation of pumping-system control that prevents surges rather than trying to minimize them.

Abrupt pump stoppage due to power failure, or to control or mechanical errors, is followed by a pressure drop as the water column continues traveling along the line. The returning column hits the closed pump check valve, creating a high pressure surge wave, which travels at up to 4 Mach. Eliminating such surge requires anticipation and precaution. **Surge Anticipating Valves** react to the pressure drop, receiving the returning column while already open, thereby eliminating the surge.

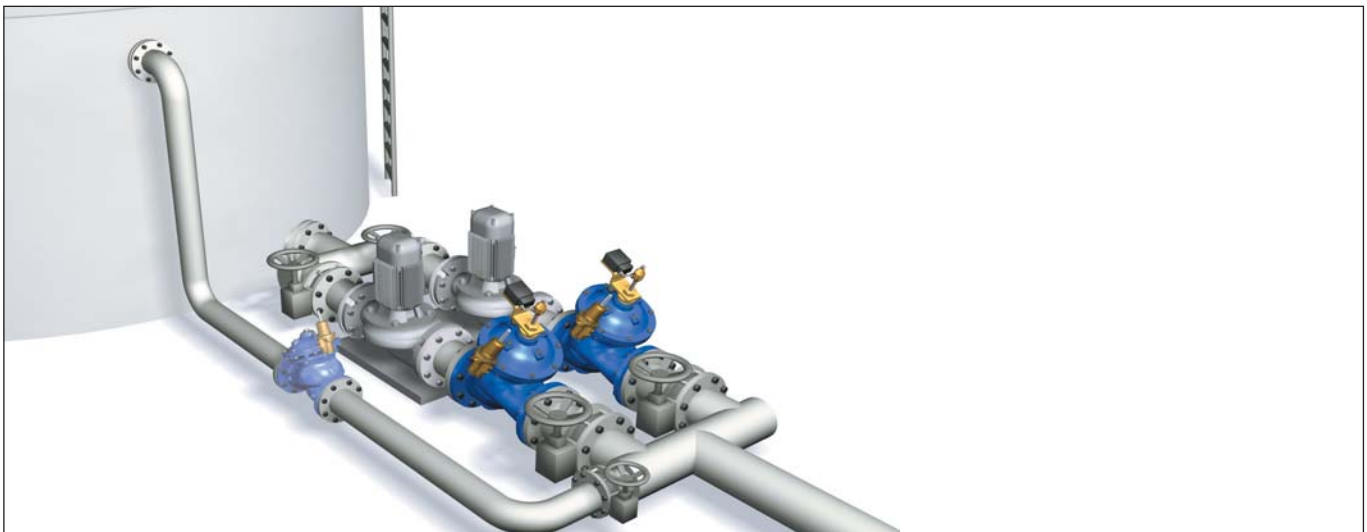
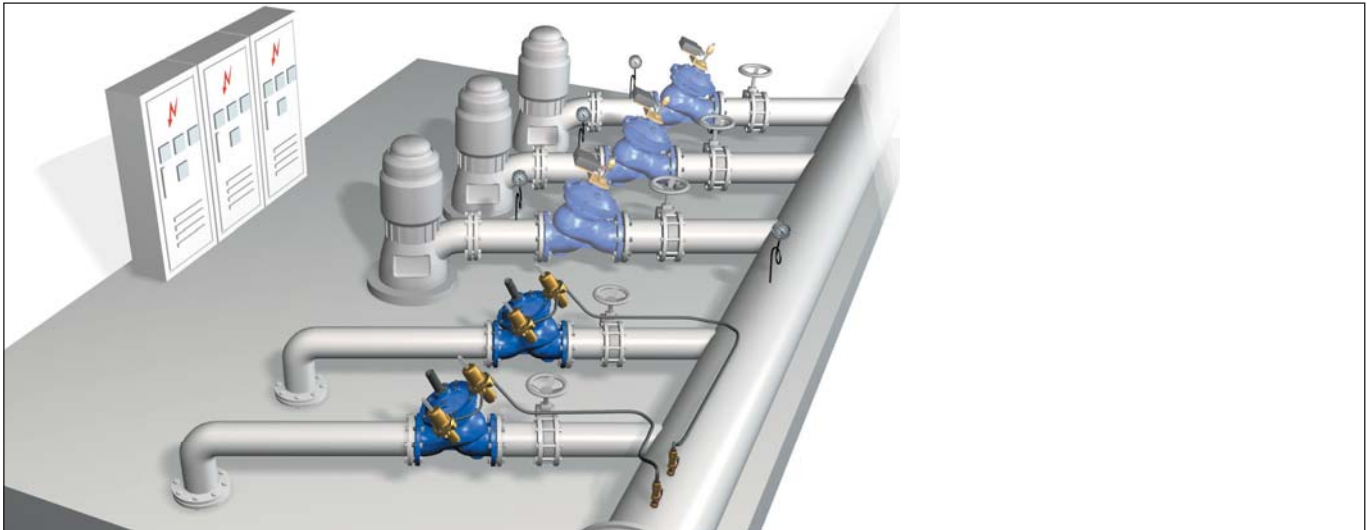

Applications Guide

Pump Control Valves

- Isolates system from the effects of pump start-ups and stops for:
 - Solitary single speed pumps
 - Battery of single speed pumps (add & switch)
 - Battery of variable speed pumps (add)
- Pump overload and cavitation protection (WW-743)
- Controlled pipeline fill-up (WW-743)

Surge Anticipating Valves

- Eliminates surge in all pumping systems:
 - Booster & deep well, single & variable speed
- Eliminates surge in all distribution networks:
 - Irrigation, municipal, sewage, HVAC
 - Difficult to maintain, remote locations, older systems



Booster Pump Control BERMAD Quick Active Check Valve

WW-740Q

The BERMAD Booster Pump Control Valve is a double chambered, hydraulically operated, diaphragm actuated, active check valve that opens fully or shuts off in response to electric signals. It isolates the pump from the system during pump start-up and stopping, to prevent pipeline surges.



Booster Pump Control & Pressure Sustaining BERMAD Active Check Valve

WW-743

The BERMAD Booster Pump Control & Pressure Sustaining Valve adds a pressure sustaining feature to the Booster Pump Control Valve. While open, it sustains minimum discharge pressure to protect the pump from overload and cavitation, and to control pipeline fill-up.



Surge Anticipating BERMAD Control Valve

WW-735-M

The BERMAD Surge Anticipating Valve is an off-line control valve. Sensing line pressure, it opens in response to the pressure drop associated with abrupt pump stoppage. The pre-opened valve dissipates the returning high pressure wave, eliminating the surge. The Model 735-M smoothly closes drip tight as quickly as the relief feature allows, while preventing closing surge. The valve also relieves excessive system pressure.



Surge Anticipating BERMAD Control Valve with Solenoid Control

WW-735-55-M

The BERMAD Model WW-735-55-M adds an electric override feature to the standard Surge Anticipating Valve, providing immediate opening in direct response to any power failure, even prior to the pressure drop associated with abrupt pump stoppage. The Model WW-735-55-M is recommended for sensitive systems as it includes redundant actuation (Hydraulic & Electric), and for "Short-Line" systems.

Pressure Reducing Valves

Maintaining hydraulic balance in water transmission and distribution systems is crucial to system efficiency. Pressure Reducing Valves help accomplish this by reducing high inlet pressure to a lower constant predetermined delivery pressure. These are the most commonly used control valves.

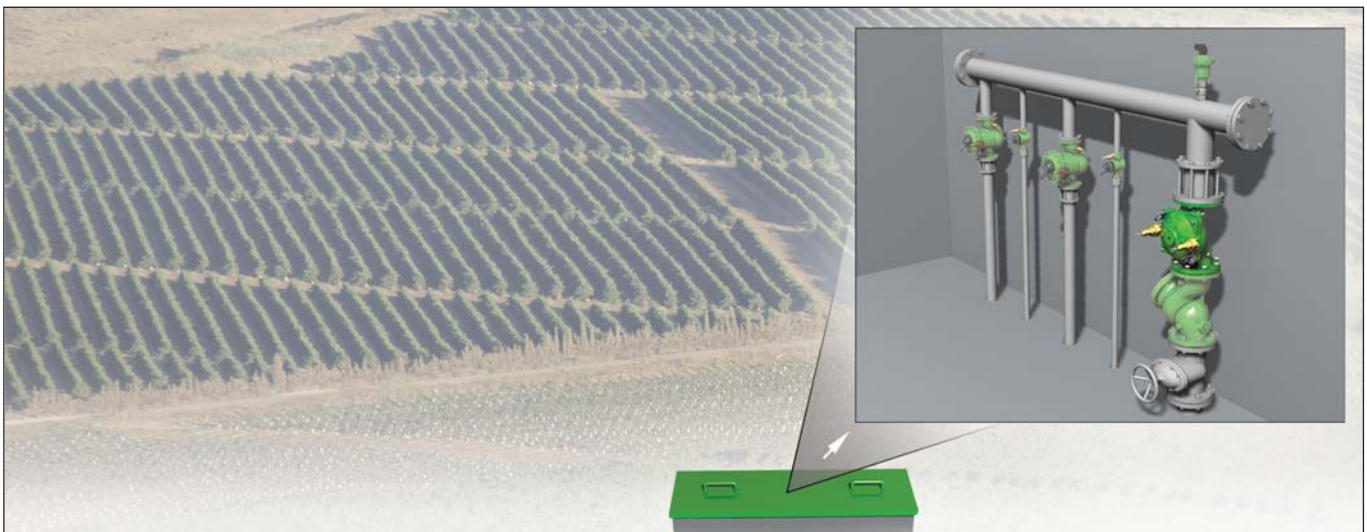

Applications Guide

- Pressure Reducing Stations
- Flow and Leakage Reduction
- Pressure Zoning
- Downhill Supply Lines
- Source & "On Duty" Valves Management (IR-420-55; WW-720-55)
- Pressure Zone Isolation (IR-420-55; WW-720-55)
- Systems Subject to Sudden Demand Changes (IR-420-48)
- Line Exposed Pressure Peaks (IR-420-48)
- Prevention of Supply Line Emptying (IR-423; WW-723)
- Higher Pressure Zone Prioritizing (IR-423; WW-723)
- Line Fill-Up Control (IR-423; WW-723)
- Pump Overload & Cavitation Protection (IR-423; WW-723)
- Downhill Serial Pressure Reduction (WW-720-PD)
- High ΔP Systems (WW-720-PD)

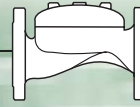

Pressure Reducing BERMAD Valve

IR-420

The BERMAD Pressure Reducing Valve is a hydraulically operated, diaphragm actuated control valve that reduces higher upstream pressure to lower constant downstream pressure regardless of fluctuating demand or varying upstream pressure.



Pressure Reducing BERMAD Valve

IR-420-XZ

This BERMAD Pressure Reducing Valve with a 3-Way control circuit reduces higher upstream pressure to lower constant downstream pressure regardless of fluctuating demand and opens fully upon line pressure drop.



Pressure Reducing BERMAD Valve with Solenoid Control

IR-420-55

The BERMAD Pressure Reducing Valve with Solenoid Control adds an On/Off control feature to the standard Pressure Reducing valve. It opens and shuts in response to an electric signal.



Pressure Reducing BERMAD Valve with Solenoid Control

IR-420-55-X

The BERMAD Pressure Reducing Valve with Solenoid Control, adds an On/Off control feature to the standard 3-Way Pressure Reducing valve. It opens and shuts in response to an electric signal.

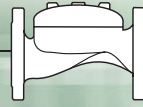

**Pressure Reducing
BERMAD Valve
with Downstream Over-Pressure Guard**

IR-420-48

The BERMAD Model IR-420-48 adds a Downstream Over-Pressure Guard feature to the standard pressure reducing valve. This enables an immediate closing response, minimizing deviation from set point caused by a sudden drop in demand or an upstream pressure peak.



**Pressure Reducing & Sustaining
BERMAD Valve**

IR-423

The BERMAD Pressure Reducing and Sustaining Valve adds a pressure sustaining feature to the standard pressure reducing valve, enabling it to perform two independent functions. When upstream pressure is high, it prevents downstream pressure from rising above maximum preset. Should upstream pressure drop, the valve throttles closed to sustain minimum preset upstream pressure, protecting supply systems.



**Pressure Reducing & Sustaining
BERMAD Valve**

IR-423-XZ

This BERMAD Pressure Reducing and Sustaining Valve with a 3-Way control circuit, performs three independent functions. When upstream pressure is high, it prevents downstream pressure from rising above maximum preset. Should upstream pressure drop, the valve throttles closed to sustain minimum preset upstream pressure - protecting supply systems. Should line pressure remain above the sustaining pilot setting but below the reducing pilot setting, the valve opens fully – reducing head lose.



Pressure Reducing BERMAD Valve

WW-720

The BERMAD Pressure Reducing Valve is a hydraulically operated, diaphragm actuated control valve that reduces higher upstream pressure to lower constant downstream pressure regardless of fluctuating demand or varying upstream pressure.



Pressure Reducing BERMAD Valve with Solenoid Control

WW-720-55

The BERMAD Pressure Reducing Valve with Solenoid Control adds an On/Off control feature to the standard Pressure Reducing valve. It opens and shuts in response to an electric signal.



Pressure Reducing & Sustaining BERMAD Valve

WW-723

The BERMAD Pressure Reducing and Sustaining Valve adds a pressure sustaining feature to the standard pressure reducing valve, enabling it to perform two independent functions. When upstream pressure is high, it prevents downstream pressure from rising above maximum preset. Should upstream pressure drop, the valve throttles closed to sustain minimum preset upstream pressure, protecting supply systems.



Proportional Pressure Reducing BERMAD Valve

IR-720-PD

The BERMAD Proportional Pressure Reducing Valve is a pilot-less, double chambered, hydraulic control valve that reduces higher upstream pressure to lower downstream pressure at a fixed ratio.

Pressure Relief Valves

Sudden changes in demand - switching of irrigation Shifts, closing of reservoir valves, air release valve action, completion of line fill-up, and so on - create a high pressure wave, which travels along the line. Pressure Relief Valves, when carefully designed, selected, sized and positioned, are the most secure simple and cost-effective way of dealing with such problems. They relieve excessive system pressure by opening fully in response to a pressure rise, responding immediately, accurately, and with high repeatability.



Applications Guide

- Pressure Reducing Stations
- System Burst Protection
- Momentary Pressure Peak Elimination
- System Failure Visual Indication
- Filter Burst Protection



Pressure Relief BERMAD Valve

IR-43Q

The BERMAD Quick Pressure Relief Valve is a single chambered, hydraulically operated, diaphragm actuated control valve that responds immediately, accurately, and with high repeatability, relieving excessive system pressure when this pressure rises above the pre-set value. The Model IR-43Q provides smooth drip tight closing.



Pressure Relief BERMAD Valve

WW-73Q

The BERMAD Model 73Q Quick Pressure Relief Valve is a double chambered control valve. This excels a diaphragm isolated from flow & protected, balanced seal disk to ensure higher flow rates at higher ΔP , and larger closing force with restrained drip tight closing.

Pressure Relief / Sustaining Valves

Pressure Relief/Sustaining Valves protect pumps and water distribution systems from two extreme situations:

- When installed off-line, they relieve damaging excessive pressure.
- When installed in-line, they sustain minimum back pressure, thus prioritizing pressure zones, and preventing line emptying, pump overload, etc.



Typical Applications

- Prevention of Downhill Supply Line Emptying
- Pressure Zone Prioritizing
- Line Fill-Up Control
- Pump Overload and Cavitation Protection
- Pump Minimum Flow Safeguarding
- Excessive Line Pressure Protection
- Systems with Various Pressure Regimes (IR-430-55)
- Backup for Reservoir Supply Valves (IR-430-55)
- Filter Emergency By-Pass (WW-736)



Pressure Relief / Sustaining BERMAD Valve

IR-430

WW-730

The BERMAD Pressure Relief/Sustaining Valve is a hydraulically operated, diaphragm actuated control valve that can fulfill either of two separate functions. When installed in-line, it sustains minimum preset upstream (back) pressure regardless of fluctuating flow or varying downstream pressure. When installed as a relief or circulation valve, it relieves line pressure in excess of preset value.



Pressure Sustaining BERMAD Valve

IR-430-XZ

This BERMAD Pressure Relief/Sustaining Valve with a 3-Way control circuit sustains minimum preset upstream (back) pressure regardless of fluctuating flow or varying downstream pressure. It opens fully upon line pressure rise above setting, saving system head loss & energy.



Pressure Relief / Sustaining BERMAD Valve with Solenoid Control

IR-430-55

WW-730-55

The BERMAD Pressure Sustaining Valve with Solenoid Control adds an On/Off control feature to the standard pressure sustaining valve. It opens and shuts in response to an electric signal, controlling systems with various pressure regimes or serving as backup for reservoir supply valves.



Differential Pressure Sustaining BERMAD Valve

WW-736

The BERMAD Differential Pressure Sustaining Valve sustains minimum pre-set differential pressure between two points such as pump suction and discharge, filter inlet and outlet, heat exchanger or chiller distribution and collection lines, etc.

Irrigation for Agriculture

Irrigation Control Head

The **Irrigation Control Head** transforms the Main Network into an irrigation system, enabling computerization of irrigation. Including a variety of large size control valves in a variety of applications, the **Irrigation Control Head** features:

- Water metering abilities with outputs to the irrigation controller
- Maintaining of demand and pressure per system design
- Pressure zoning in accordance with crop, equipment, location and elevation
- Differentiation of irrigation regimes to meet the needs of each crop type and stage
- Central fertilization and filtration systems

BERMAD Irrigation

Irrigation Control Head

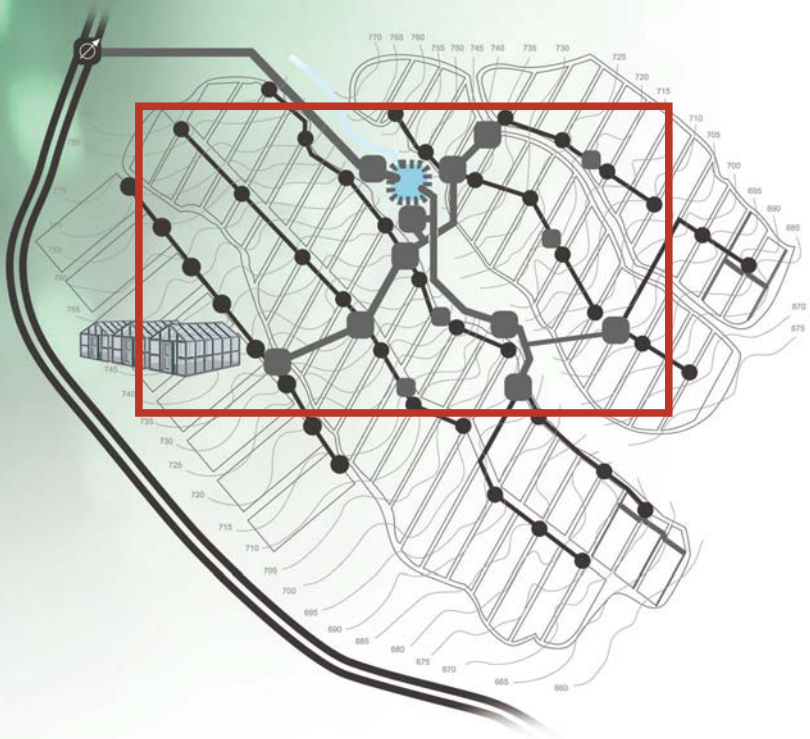

Irrigation Control Head

 Irrigation Control Head

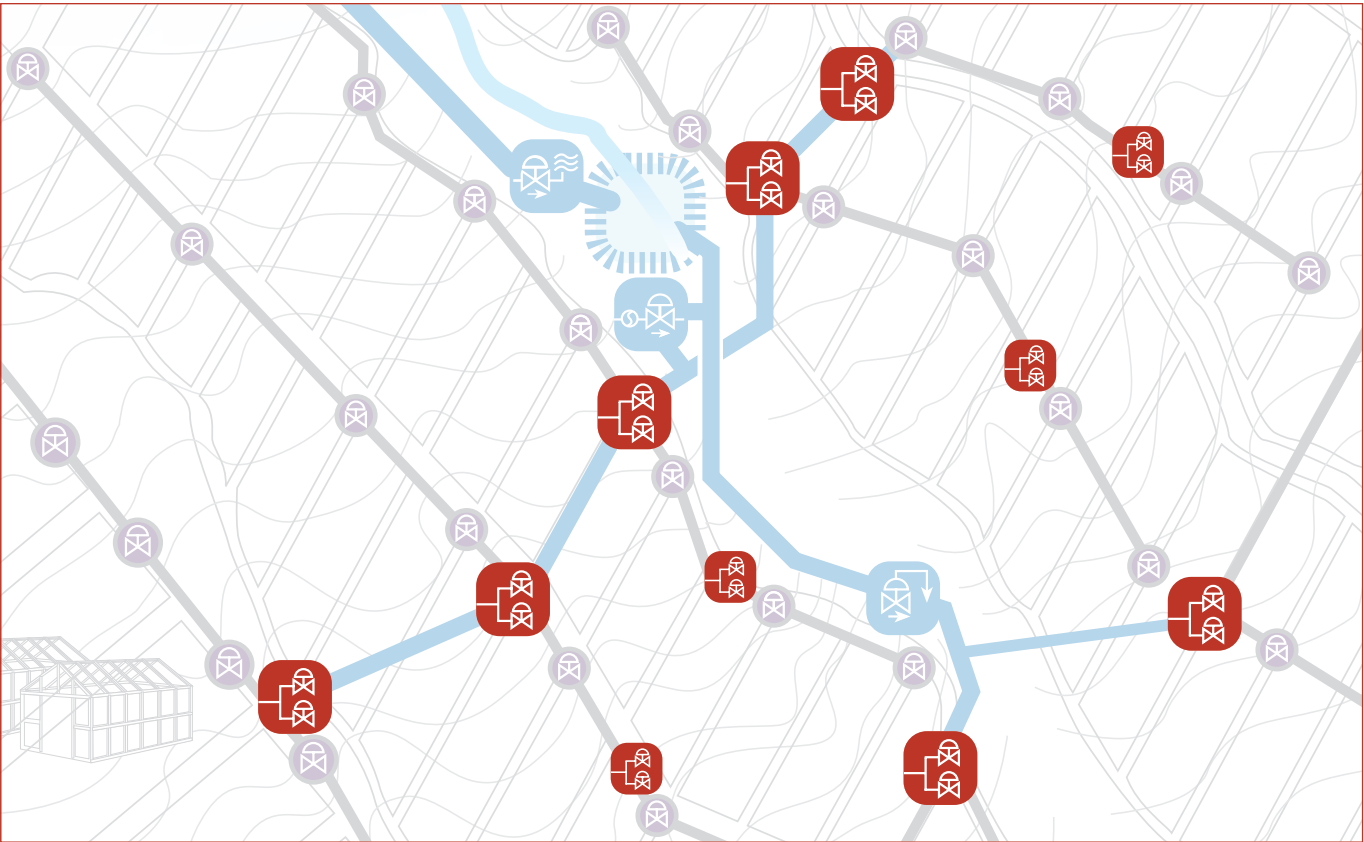

On/Off Control



Pressure Reducing



Pressure Relief

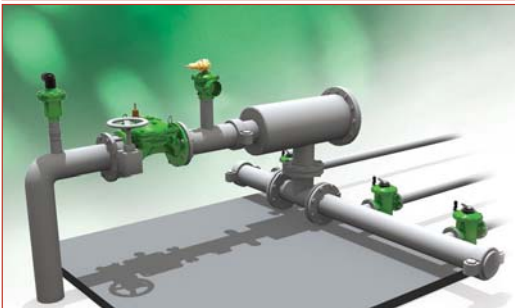

Flow Control



Pressure Sustaining



Filter Stations

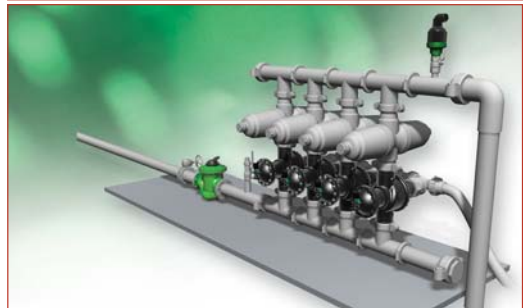

On/Off Control Valves

On/Off Control Valves are hydraulically or electrically activated valves that can be locally or remotely triggered to open or close. Proper selection of valve types and normal position (Open or Closed), allows for meeting the design requirements of any desired control system and level.



Typical Applications:

- Computerized Irrigation Systems
- Manual Irrigation Systems Intended for Computerization
- Semi-Automatic Irrigation Systems (IR-900-D2, IR-900-E2)
- Remote and/or Elevated Systems (Additional Features 54 & 55)
- Remote Flow Monitoring & Leakage Control (IR-900-M0)
- Irrigation Machines

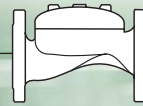

Hydraulic Control BERMAD Valve

IR-405-Z

The BERMAD Hydraulic Control Valve is a hydraulically operated, diaphragm actuated control valve that opens and shuts off in response to a local or remote pressure command.



Hydraulic Control BERMAD Valve, Normally Closed with Hydraulic Relay

IR-405-54-RXZ

This Normally Closed, line pressure driven, hydraulic control valve opens in response to an external hydraulic pressure rise command and shuts in the absence of that command. Its metal control accessories and circuit ensure a rigid, damage resistant main valve.



Solenoid Controlled BERMAD Valve

IR-410-X

This Solenoid Controlled, line pressure driven, hydraulically operated valve opens or shuts in response to an electric signal. Its metal control accessories and circuit ensure a rigid, damage resistant main valve. The solenoid is compliant with common controllers on the market, and features a manual override.

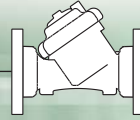

Hydraulic Control BERMAD Valve

IR-105-Z

The BERMAD Hydraulic Control Valve is a hydraulically operated, diaphragm actuated control valve that opens and shuts off in response to a local or remote pressure command.



Hydraulic Control BERMAD Valve, Normally Closed with Hydraulic Relay

IR-105-54-X

This Normally Closed, line pressure driven, hydraulic control valve opens in response to an external hydraulic pressure rise command and shuts in the absence of that command.



Solenoid Controlled BERMAD Valve

IR-110-X

This Solenoid Controlled, line pressure driven, hydraulically operated valve, opens or shuts in response to an electric signal. The solenoid is compliant with common controllers on the market and it features a manual override.

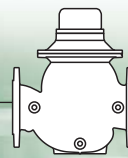

Hydrometer BERMAD with Magnetic Drive

IR-900-MO-Z

The BERMAD Hydrometer with Magnetic Drive integrates a vertical turbine Woltman-type water meter with a diaphragm actuated hydraulic control valve. The impeller drive is magnetically coupled to a vacuum-sealed meter register in the control head. As the system's flow meter and main valve. The Hydrometer controls system irrigation together with the irrigation controller. It opens and shuts in response to a local or remote pressure command.



Hydrometer BERMAD Magnetic Drive, Normally Closed with Hydraulic Relay

IR-900-MO-54-RXZ

This Normally Closed, line pressure driven Hydrometer with Magnetic Drive opens in response to an external hydraulic pressure rise command and shuts in the absence of that command. Its metal control accessories and circuit ensure a rigid, damage resistant hydrometer.



Hydrometer BERMAD, Magnetic Drive with Solenoid Control

IR-910-MO-RX

This Solenoid Controlled, line pressure driven Hydrometer with Magnetic Drive, opens or shuts in response to an electric signal. The solenoid is compliant with common controllers on the market and features a manual override.



Automatic Metering Valve (AMV) BERMAD

IR-900-D2

The BERMAD Automatic Metering Valve integrates a vertical turbine Woltman-type water meter with a diaphragm actuated hydraulic control valve. Equipped with a Mechanical Shut-Off Pilot, the BERMAD IR-900-D2 enables volumetric irrigation in non-computerized systems. It automatically shuts itself off after accurately delivering a manually preset quantity of water.



Automatic Metering Valve (AMV) BERMAD for Sequential Irrigation

IR-900-E2

This BERMAD Automatic Metering Valve is equipped with a mechanical sequential shut-off pilot. When open, it transmutes pressure to the Next AMV, closing it. When the AMV shuts itself, it allows the next AMV to open and deliver a manually preset quantity of water.

Working in a group of manually preset AMV's connected to each other by a control tube and operating in sequence, it enables semi-automatic irrigation in non-computerized systems.

Pressure Reducing Control Valves

The transformation from the main network into the irrigation system often requires bridging of significant differences in pressure ratings and flow characteristics. Pressure Reducing Valves help accomplish this by reducing high and fluctuating inlet pressure to a lower constant predetermined delivery pressure. They maintain pressure per system design and help to form pressure zones in accordance with crop, equipment, location, elevation and irrigation regimes.



Typical Applications:

- Pressure Reducing Systems
- Distribution Centers
- Computerized Irrigation Systems
- Manual Irrigation Systems Intended for Computerization
- Semi-Automatic Irrigation Systems (IR-920-D2)
- Remote Flow Monitoring & Leakage Control (IR-920-M0)
- Remote and/or Elevated Systems (Additional Features 54 & 55)
- Irrigation Machines
- Greenhouse irrigation centers

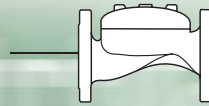

IR-420-R

Pressure Reducing BERMAD Valve

The BERMAD Pressure Reducing Valve is a line pressure driven control valve that reduces higher upstream pressure to lower constant downstream pressure regardless of fluctuating demand or varying upstream pressure. Its metal control accessories and circuit ensure a rigid, damage resistant valve.

The Model IR-420-RX automatically opens fully upon pressure drop below setting.

- IR-420-R**
- IR-420-RX**



IR-420-50-R

Pressure Reducing BERMAD Valve with Hydraulic Control

This Normally Open, line pressure driven Pressure Reducing Valve shuts in response to an external hydraulic pressure rise command. Its metal control accessories and circuit ensure a rigid, damage resistant main valve.

The Model IR-420-50-RX automatically opens fully upon pressure drop below setting.

- IR-420-50-R**
- IR-420-50-RX**



IR-420-54-R

Pressure Reducing BERMAD Valve, Normally Closed with Hydraulic Relay

This Normally Closed, line pressure driven Pressure Reducing Valve opens in response to an external hydraulic pressure rise command and shuts in the absence of that command. Its metal control accessories and circuit ensure a rigid, damage resistant main valve.

The Model IR-420-54-RX automatically opens fully upon pressure drop below setting.

- IR-420-54-R**
- IR-420-54-RX**



IR-420-55-R

Pressure Reducing BERMAD Valve with Solenoid Control

This Solenoid Controlled, line pressure driven Pressure Reducing Valve opens or shuts in response to an electric signal. Its metal control accessories and circuit ensure a rigid, damage resistant main valve. The solenoid is compliant with common controllers on the market.

The Model IR-420-55-RX automatically opens fully upon pressure drop below setting.

- IR-420-55-R**
- IR-420-55-RX**

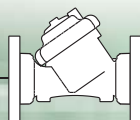

IR-120

Pressure Reducing BERMAD Valve

IR-120

IR-120-X

The BERMAD Pressure Reducing Valve is a line pressure driven control valve that reduces higher upstream pressure to lower constant downstream pressure regardless of fluctuating demand or varying upstream pressure.

The Model IR-120-X automatically opens fully upon pressure drop below setting.



IR-120-50

Pressure Reducing BERMAD Valve with Hydraulic Control

IR-120-50

IR-120-50-X

This Normally Open, line pressure driven Pressure Reducing Valve shuts in response to an external hydraulic pressure rise command.

The Model IR-120-50-X automatically opens fully upon pressure drop below setting.



IR-120-54

Pressure Reducing BERMAD Valve, Normally Closed with Hydraulic Relay

IR-120-54

IR-120-54-X

This Normally Closed, line pressure driven Pressure Reducing Valve opens in response to an external hydraulic pressure rise command and shuts in the absence of that command.

The Model IR-120-54-X automatically opens fully upon pressure drop below setting.



IR-120-55

Pressure Reducing BERMAD Valve with Solenoid Control

IR-120-55

IR-120-55-X

This Solenoid Controlled, line pressure driven Pressure Reducing Valve opens or shuts in response to an electric signal. The solenoid is compliant with common controllers on the market and it features a manual override.

The Model IR-120-55-X automatically opens fully upon pressure drop below setting.

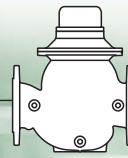

IR-920-M0-R

Pressure Reducing BERMAD Hydrometer, with Magnetic Drive

- IR-920-M0-R**
- IR-920-M0-RX**

The BERMAD Pressure Reducing Hydrometer integrates a vertical turbine Woltman-type water meter, with a diaphragm actuated hydraulic control valve. It reduces higher upstream pressure to lower constant downstream pressure regardless of fluctuating demand or varying upstream pressure. Its metal control accessories and circuit provide a rigid, damage resistant valve. The Model IR-920-M0-RX automatically opens fully upon pressure drop below setting.



IR-920-M0-50-R

Pressure Reducing BERMAD Hydrometer, Magnetic Drive with Hydraulic Control

- IR-920-M0-50-R**
- IR-920-M0-50-RX**

This Normally Open, Pressure Reducing Hydrometer shuts in response to an external hydraulic pressure rise command. The Model IR-920-M0-50-RX automatically opens fully upon pressure drop below setting.



IR-920-M0-54-R

Pressure Reducing BERMAD Hydrometer, Magnetic Drive Normally Closed with Hydraulic Relay

- IR-920-M0-54-R**
- IR-920-M0-54-RX**

This Normally Closed, Pressure Reducing Hydrometer opens in response to an external hydraulic pressure rise command and shuts in the absence of that command. The Model IR-920-M0-54-RX automatically opens fully upon pressure drop below setting.



IR-920-M0-55-R

Pressure Reducing BERMAD Hydrometer, Magnetic Drive with Solenoid Control

- IR-920-M0-55-R**
- IR-920-M0-55-RX**

This Solenoid Controlled, Pressure Reducing Hydrometer opens or shuts in response to an electric signal. The solenoid is compliant with common controllers on the market. The Model IR-920-M0-55-RX automatically opens fully upon pressure drop below setting.



IR-920-D2-R

Pressure Reducing BERMAD Automatic Metering Valve (AMV)

- IR-920-D2-R**
- IR-920-D2-RX**

The BERMAD Pressure Reducing Automatic Metering Valve integrates a vertical turbine Woltman-type water meter, with a diaphragm actuated hydraulic control valve. Equipped with a Shut-Off Pilot and a Pressure Reducing Pilot, the BERMAD IR-920-D2-R reduces higher upstream pressure to lower constant downstream pressure. It automatically shuts itself off after accurately delivering a preset quantity of water. The Model IR-920-D2-RX automatically opens fully upon pressure drop below setting.

Pressure Reducing & Sustaining Control Valves

The Main Network is sometimes exposed to supply pressure drop due to system over-demand during unbalanced irrigation, line fill-up, reservoir filling, filter backwash, etc. Pressure Reducing and Sustaining Valves add a pressure sustaining feature to the standard pressure reducing valve, limiting the flow to sustain the minimum required supply pressure, while protecting irrigation systems downstream from the irrigation control head.

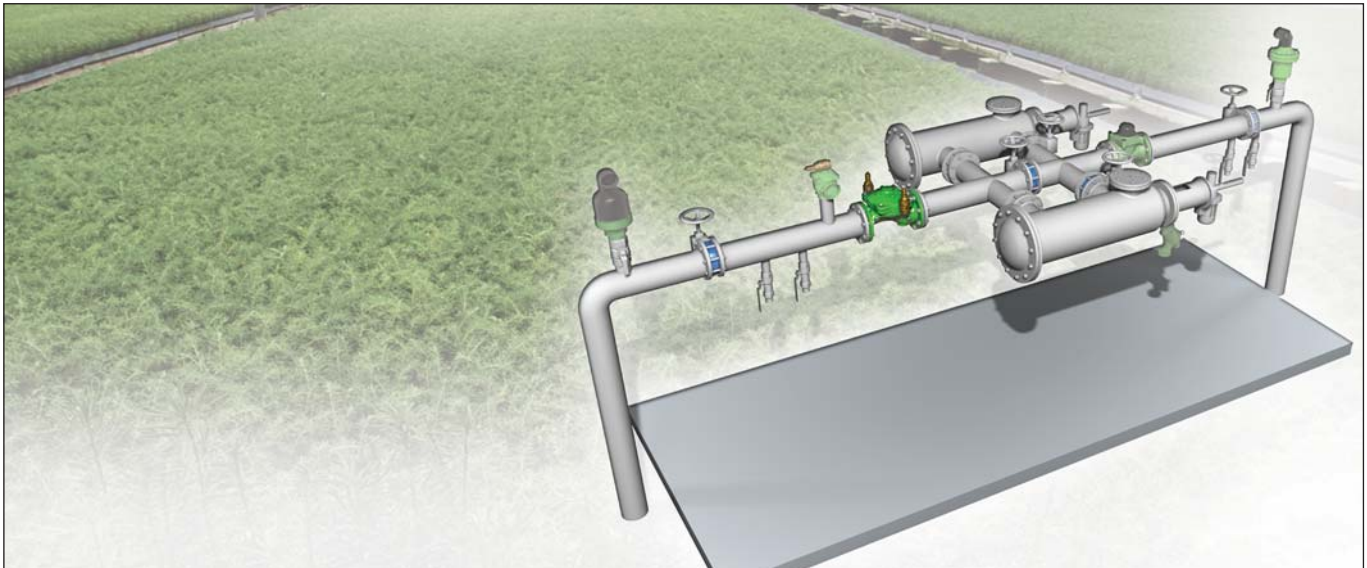

Typical Applications

- Pressure Reducing Systems
- Line Fill-Up Control
- Line Emptying Prevention
- Distribution Centers
- Filter Stations
- Computerized Irrigation Systems
- Manual Irrigation Systems Intended for Computerization
- Semi-Automatic Irrigation Systems (IR-923-D2)
- Remote Flow Monitoring & Leakage Control (IR-923-M0)
- Remote and/or Elevated Systems (Additional Features 54 & 55)
- Irrigation Machines
- Greenhouses Irrigation Centers

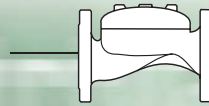

IR-423-R

Pressure Reducing & Sustaining BERMAD Valve

IR-423-R

IR-423-RX

The BERMAD Pressure Reducing and Sustaining Valve is a line pressure driven control valve that performs two independent functions. It sustains the preset minimum upstream pressure, and reduces downstream pressure to a constant preset maximum. The metal control accessories and circuit provide a rigid, damage resistant valve.

The Model IR-423-RX automatically opens fully when line pressure is above sustaining pilot set-point and below reducing pilot set-point.



IR-423-50-R

Pressure Reducing & Sustaining BERMAD Valve with Hydraulic Control

IR-423-50-R

IR-423-50-RX

This Normally Open, line pressure driven Pressure Reducing and Sustaining Valve shuts in response to an external hydraulic pressure rise command. Its metal control accessories and circuit provide a rigid, damage resistant main valve.

The Model IR-423-50-RX automatically opens fully when line pressure is above sustaining pilot set-point and below reducing pilot set-point.



IR-423-55-R

Pressure Reducing & Sustaining BERMAD Valve with Solenoid Control

IR-423-55-R

IR-423-55-RX

This Solenoid Controlled, line pressure driven Pressure Reducing and Sustaining Valve opens or shuts in response to an electric signal. Its metal control accessories and circuit provide a rigid, damage resistant main valve. The solenoid is compliant with common controllers on the market.

The Model IR-423-55-RX automatically opens fully when line pressure is above sustaining pilot set-point and below reducing pilot set-point.

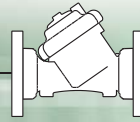

IR-123

Pressure Reducing & Sustaining BERMAD Valve

IR-123

IR-123-X

The BERMAD Pressure Reducing and Sustaining Valve is a line pressure driven control valve that performs two independent functions. It sustains the preset minimum upstream pressure, and reduces downstream pressure to a constant preset maximum.

The Model IR-123-X automatically opens fully when line pressure is above sustaining pilot set-point and below reducing pilot set-point.



IR-123-50

Pressure Reducing & Sustaining BERMAD Valve with Hydraulic Control

IR-123-50

IR-123-50-X

This Normally Open, line pressure driven Pressure Reducing and Sustaining Valve shuts in response to an external hydraulic pressure rise command.

The Model IR-123-50-X automatically opens fully when line pressure is above sustaining pilot set-point and below reducing pilot set-point.



IR-123-55

Pressure Reducing & Sustaining BERMAD Valve with Solenoid Control

IR-123-55

IR-123-55-X

This Solenoid Controlled, line pressure driven Pressure Reducing and Sustaining Valve opens or shuts in response to an electric signal. The solenoid is compliant with common controllers on the market and it features a manual override.

The Model IR-123-55-X automatically opens fully when line pressure is above sustaining pilot set-point and below reducing pilot set-point.

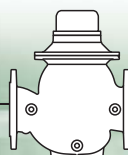

IR-923-M0-R

**Pressure Reducing & Sustaining
BERMAD Hydrometer,
Magnetic Drive**

IR-923-M0-R

IR-923-M0-RX

The BERMAD Pressure Reducing and Sustaining Hydrometer integrates a vertical turbine Woltman-type water meter, with a diaphragm actuated hydraulic control valve. The impeller drive is magnetically coupled to a vacuum-sealed meter register in the control head. The Hydrometer performs two independent functions. It sustains the preset minimum upstream pressure, and reduces downstream pressure to a constant preset maximum. Its metal control accessories and circuit provide a rigid, damage resistant valve.

The Model IR-923-M0-RX automatically opens fully when line pressure is above sustaining pilot set-point and below reducing pilot set-point.



IR-923-M0-50-R

**Pressure Reducing & Sustaining
BERMAD Hydrometer,
Magnetic Drive with Hydraulic Control**

IR-923-M0-50-R

IR-923-M0-50-RX

This Normally Open, Pressure Reducing and Sustaining Hydrometer shuts in response to an external hydraulic pressure rise command. As the system's flow meter and main valve, it controls system irrigation together with the irrigation controller. The Model IR-923-M0-50-RX automatically opens fully when line pressure is above sustaining pilot set-point and below reducing pilot set-point.



IR-923-M0-55-R

**Pressure Reducing & Sustaining
BERMAD Hydrometer,
Magnetic Drive with Solenoid Control**

IR-923-M0-55-R

IR-923-M0-55-RX

This Solenoid Controlled, Pressure Reducing and Sustaining Hydrometer opens or shuts in response to an electric signal. As the system's flow meter and main valve, it controls system irrigation together with the irrigation controller. The solenoid is compliant with controllers on the market.

The Model IR-923-M0-55-RX automatically opens fully when line pressure is above sustaining pilot set-point and below reducing pilot set-point.



IR-923-D2-R

**Pressure Reducing & Sustaining
BERMAD Automatic Metering Valve (AMV)**

IR-923-D2-R

IR-923-D2-RX

The BERMAD Pressure Reducing & Sustaining Automatic Metering Valve integrates a vertical turbine Woltman-type water meter, with a diaphragm actuated hydraulic control valve. The AMV performs three independent functions. It sustains the preset minimum upstream pressure, reduces downstream pressure to a constant preset maximum, and automatically shuts itself off after accurately delivering a preset quantity of water.

The Model IR-923-D2-RX automatically opens fully when line pressure is above sustaining pilot set-point and below reducing pilot set-point.

Pressure Relief Valves

Sudden changes in demand, switching irrigation shifts, air release valve action, line fill-up ending, and so on, create a high pressure wave, which travels along the line. Pressure Relief Valves, carefully designed, selected, sized, and located are the most simple, secure and cost effective way to deal with such problems. They immediately, accurately, and with high repeatability relieve excessive system pressure by opening fully in response to system pressure rise.

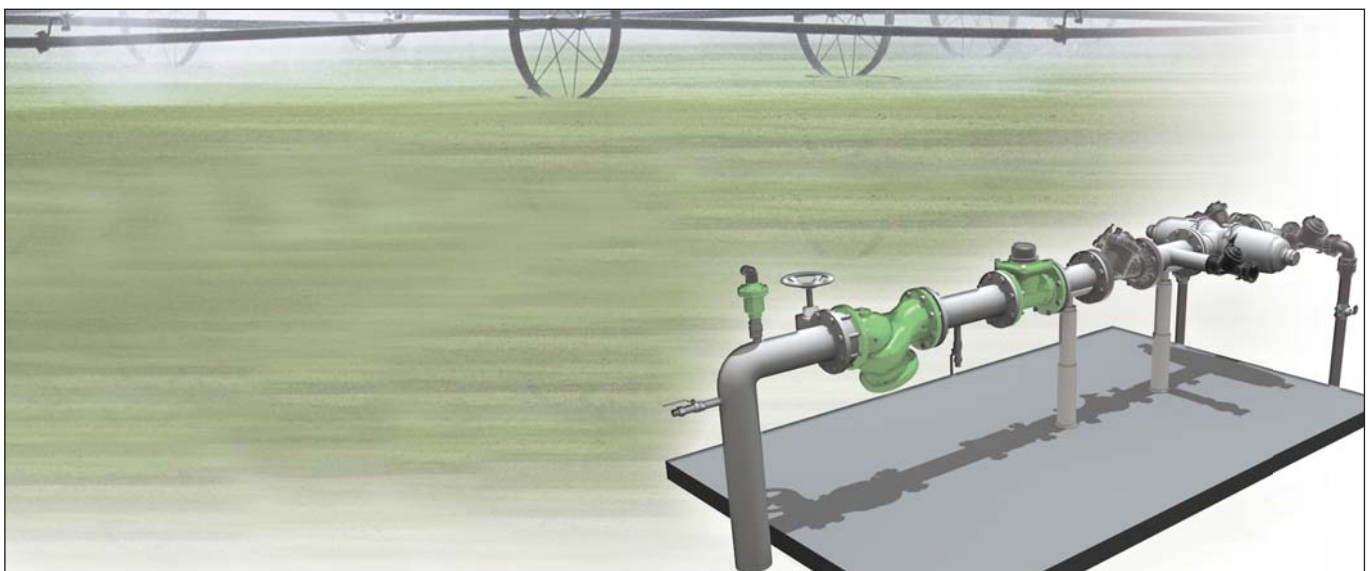

Typical Applications

- Pressure Reducing Stations
- System Burst Protection
- Momentary Pressure Peak Elimination
- System Failure Visual Indication
- Filter Burst Protection



Pressure Relief BERMAD Valve

IR-43Q

The BERMAD Quick Pressure Relief Valve is a single chambered, hydraulically operated, diaphragm actuated control valve that immediately, accurately, and with high repeatability relieves excessive system pressure when this pressure rises above the pre-set value. The Model IR-43Q provides smooth drip tight closing.



Pressure Relief BERMAD Valve

IR-13Q

This quick-acting pressure relief valve is an engineered plastic control valve. It excels in its high durability, chemical and cavitation resistance, hYflow 'Y' valve body with "look through" design providing ultra-high flow capacity, and unitized flexible diaphragm with a guided plug preventing diaphragm distortion.

Flow Control Valves

Meters, filters, pumps and other distribution equipment might experience flows that exceed their operating capacity due to system over-demand during unbalanced irrigation, line fill-up, reservoir filling, filter backwash, etc. Flow Control Valves maintain a preset maximum flow rate regardless of variations in demand or upstream/downstream pressure.



Typical Applications

- Multiple Independent Consumer Systems
- Pressure Reducing Systems (IR-472, IR-172, IR-972)
- Line Fill-Up Control
- Distribution Centers
- Computerized Irrigation Systems
- Manual Irrigation Systems Intended for Computerization
- Semi-Automatic Irrigation Systems (IR-970-D2)
- Remote Flow Monitoring & Leakage Control (IR-970-M0)
- Remote and/or Elevated Systems (Additional Features 54 & 55)
- Greenhouse Irrigation Centers

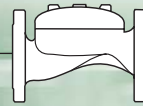

**Flow Control BERMAD Valve
with Hydraulic Control**

IR-470-50-bRUZ

The BERMAD Normally Open, Flow Control Valve is a line pressure driven control valve that controls system demand maintaining a preset maximum flow rate. It is commanded by a flow pilot, which senses the ΔP across an orifice installed upstream from the valve. The valve shuts in response to an external hydraulic pressure rise command. The metal control accessories and circuit provide a rigid, damage resistant main valve.



**Flow Control BERMAD Valve
with Solenoid Control**

IR-470-55-bRU

This Solenoid Controlled, line pressure driven Flow Control Valve opens or shuts in response to an electric signal. Its metal control accessories and circuit provide a rigid, damage resistant main valve. The solenoid is compliant with common controllers on the market.



**Flow Control & Pressure Reducing
BERMAD Valve
with Hydraulic Control**

IR-472-50-bRUZ

The BERMAD Normally Open, Flow Control and Pressure Reducing Valve is a line pressure driven control valve that performs two independent functions. It controls system demand maintaining a preset maximum flow rate, and reduces downstream pressure to a constant preset maximum. The metal control accessories and circuit provide a rigid, damage resistant main valve.



**Flow Control & Pressure Reducing
BERMAD Valve
with Solenoid Control**

IR-472-55-bRU

This Solenoid Controlled, line pressure driven Flow Control and Pressure Valve opens or shuts in response to an electric signal. Its metal control accessories and circuit provide a rigid, damage resistant main valve. The solenoid is compliant with common controllers on the market.

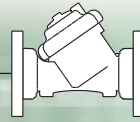

Flow Control BERMAD Valve with Hydraulic Control

IR-170-50-bDZ

The BERMAD Normally Open, Flow Control Valve is a line pressure driven control valve that controls system demand maintaining a preset maximum flow rate. It is commanded by a flow pilot, which senses the ΔP across a Differential Pressure Duct installed in the valve. The valve shuts in response to an external hydraulic pressure rise command.



Flow Control BERMAD Valve with Solenoid Control

IR-170-55-bD

This Solenoid Controlled, line pressure driven Flow Control Valve opens or shuts in response to an electric signal. The solenoid is compliant with common controllers on the market and it features a manual override.



Flow Control & Pressure Reducing BERMAD Valve with Hydraulic Control

IR-172-50-bDZ

The BERMAD Normally Open, Flow Control and Pressure Reducing Valve is a line pressure driven control valve that performs two independent functions. It controls system demand maintaining a preset maximum flow rate, and reduces downstream pressure to a constant preset maximum.



Flow Control & Pressure Reducing BERMAD Valve with Solenoid Control

IR-172-55-bD

This Solenoid Controlled, line pressure driven Flow Control and Pressure Valve opens or shuts in response to an electric signal. The solenoid is compliant with common controllers on the market and it features a manual override.

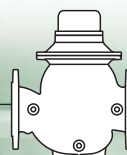

Flow Control BERMAD Hydrometer, Magnetic Drive with Hydraulic Control

IR-970-MO-50-RVZ

The BERMAD Normally Open, Flow Control Hydrometer integrates a vertical turbine Woltman-type water meter, with a diaphragm actuated hydraulic control valve. The impeller drive is magnetically coupled to a vacuum-sealed meter register in the control head. The Hydrometer controls system demand maintaining a preset maximum flow rate. It is commanded by a paddle flow pilot, which includes a paddle that is positioned within the flow stream. As the system's flow meter and main valve, it controls system irrigation together with the irrigation controller. It shuts in response to an external hydraulic pressure rise command.



Flow Control BERMAD Hydrometer, Magnetic Drive with Solenoid Control

IR-970-MO-55-RV

This Solenoid Controlled, line pressure driven Flow Control Hydrometer opens or shuts in response to an electric signal. As the system's flow meter and main valve, it controls system irrigation together with the irrigation controller. The solenoid is compliant with common controllers on the market.



Flow Control & Pressure Reducing BERMAD Hydrometer, Magnetic Drive with Hydraulic Control

IR-972-MO-50-RVZ

The BERMAD Normally Open, Flow Control and Pressure Reducing Hydrometer performs two independent functions. It controls system demand maintaining a preset maximum flow rate, and reduces downstream pressure to a constant preset maximum. As the system's flow meter and main valve, it controls system irrigation together with the irrigation controller.



Flow Control & Pressure Reducing BERMAD Hydrometer, Magnetic Drive with Solenoid Control

IR-972-MO-55-RV

This Solenoid Controlled, line pressure driven Flow Control and Pressure Reducing Hydrometer opens or shuts in response to an electric signal. As the system's flow meter and main valve, it controls system irrigation together with the irrigation controller. The solenoid is compliant with common controllers on the market.



Flow Control & Pressure Reducing BERMAD Automatic Metering Valve (AMV)

IR-972-D2-RV

The BERMAD Flow Control and Pressure Reducing Automatic Metering Valve integrates a vertical turbine Woltman-type water meter, with a diaphragm actuated hydraulic control valve. The AMV performs three independent functions. It controls system demand maintaining a preset maximum flow rate, reduces downstream pressure to a constant preset maximum, and automatically shuts itself off after accurately delivering a preset quantity of water.

Pressure Sustaining Control Valves

Pressure Sustaining Valves protect pumps and water distribution systems from two extreme situations:

- When installed in-line, they sustain minimum back pressure thus prioritizing pressure zones, controlling line fill-up, ensuring filter backwash pressure, preventing line emptying and pump overload, etc.
- When installed off-line, they relieve damaging excessive pressure, protecting pump and system.



Typical Applications

- Line Fill-Up Control
- Pressure Zone Prioritizing
- Line Emptying Prevention
- Pump Circulation
- Computerized Irrigation Systems
- Manual Irrigation Systems Intended for Computerization
- Semi-Automatic Irrigation Systems (IR-930-D2)
- Remote Flow Monitoring & Leakage Control (IR-930-M0)
- Remote and/or Elevated Systems (Additional Features 54 & 55)
- Irrigation Machines
- Greenhouse Irrigation Centers

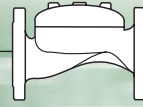

IR-430-50-R

Pressure Sustaining BERMAD Valve with Hydraulic Control

- IR-430-50-R
- IR-430-50-RX

The BERMAD Normally Open, Pressure Sustaining Valve is a line pressure driven control valve that sustains minimum preset upstream (back) pressure regardless of fluctuating flow or varying downstream pressure. When installed offline, the BERMAD Model IR-430-50-R relieves line pressure in excess of preset. The valve shuts in response to an external hydraulic pressure rise command. The metal control accessories and circuit provide a rigid, damage resistant main valve. The Model IR-430-50-RX automatically opens fully when line pressure is in excess of setting.



IR-430-55-R

Pressure Sustaining BERMAD Valve with Solenoid Control

- IR-430-55-R
- IR-430-55-RX

This Solenoid Controlled, line pressure driven Pressure Sustaining Valve opens or shuts in response to an electric signal. Its metal control accessories and circuit provide a rigid, damage resistant main valve. The solenoid is compliant with common controllers on the market. The Model IR-430-55-RX automatically opens fully when line pressure is in excess of setting.

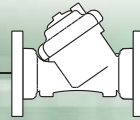

IR-130-50

Pressure Sustaining BERMAD Valve with Hydraulic Control

IR-130-50

IR-130-50-X

The BERMAD Normally Open, Pressure Sustaining Valve is a line pressure driven control valve that sustains minimum preset upstream (back) pressure regardless of fluctuating flow or varying downstream pressure. When installed offline, the Model IR-130-50 relieves line pressure in excess of preset. The valve shuts in response to an external hydraulic pressure rise command. The Model IR-130-50-X automatically opens fully when line pressure is in excess of setting.



IR-130-55

Pressure Sustaining BERMAD Valve with Solenoid Control

IR-130-55

IR-130-55-X

This Solenoid Controlled, line pressure driven Pressure Sustaining Valve opens or shuts in response to an electric signal. The solenoid is compliant with common controllers on the market and it features a manual override. The Model IR-130-55-X automatically opens fully when line pressure is in excess of setting.

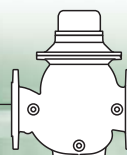

IR-930-M0-50-R

**Pressure Sustaining
BERMAD Hydrometer,
Magnetic Drive with Solenoid Control**

IR-930-M0-50-R

IR-930-M0-50-RX

The BERMAD Normally Open, Pressure Sustaining Hydrometer integrates a vertical turbine Woltman-type water meter, with a diaphragm actuated hydraulic control valve. The impeller drive is magnetically coupled to a vacuum-sealed meter register in the control head. The Hydrometer sustains minimum preset upstream (back) pressure and shuts in response to an external hydraulic pressure rise command. As the system's flow meter and main valve, it controls system irrigation together with the irrigation controller. The metal control accessories and circuit provide a rigid, damage resistant Hydrometer.

The Model IR-930-M0-50-RX automatically opens fully when line pressure is in excess of setting.



IR-930-M0-55-R

**Pressure Sustaining
BERMAD Hydrometer,
Magnetic Drive with Solenoid Control**

IR-930-M0-55-R

IR-930-M0-55-RX

This Solenoid Controlled, line pressure driven Pressure Sustaining Hydrometer opens or shuts in response to an electric signal. Its metal control accessories and circuit provide a rigid, damage resistant Hydrometer. The solenoid is compliant with common controllers on the market.

The Model IR-930-M0-55-RX automatically opens fully when line pressure is in excess of setting.



IR-930-D2-R

**Pressure Sustaining
BERMAD Automatic Metering Valve (AMV)**

IR-930-D2-R

IR-930-D2-RX

The BERMAD Pressure Sustaining Automatic Metering Valve integrates a vertical turbine Woltman-type water meter, with a diaphragm actuated hydraulic control valve. The AMV sustains minimum preset upstream (back) pressure and automatically shuts itself off after accurately delivering a preset quantity of water.

The Model IR-930-D2-RX automatically opens fully when line pressure is in excess of setting.

Filter Station Control Valves

One of the most common ways to clean sand, gravel, disk or strainer filter elements in filters used for the irrigation sector, is by backwashing them. **Filter Backwash Valves** close the inlet into the filter and divert filtered water to flow in the opposite direction through the filter element to the drain. The high flow velocity and ΔP create hydraulic forces which flush the filter-cake to the atmosphere, cleaning the filter element. **Flow Control Valves** limit the backwash flow to protect the filter element from excessive flow velocity and ΔP .

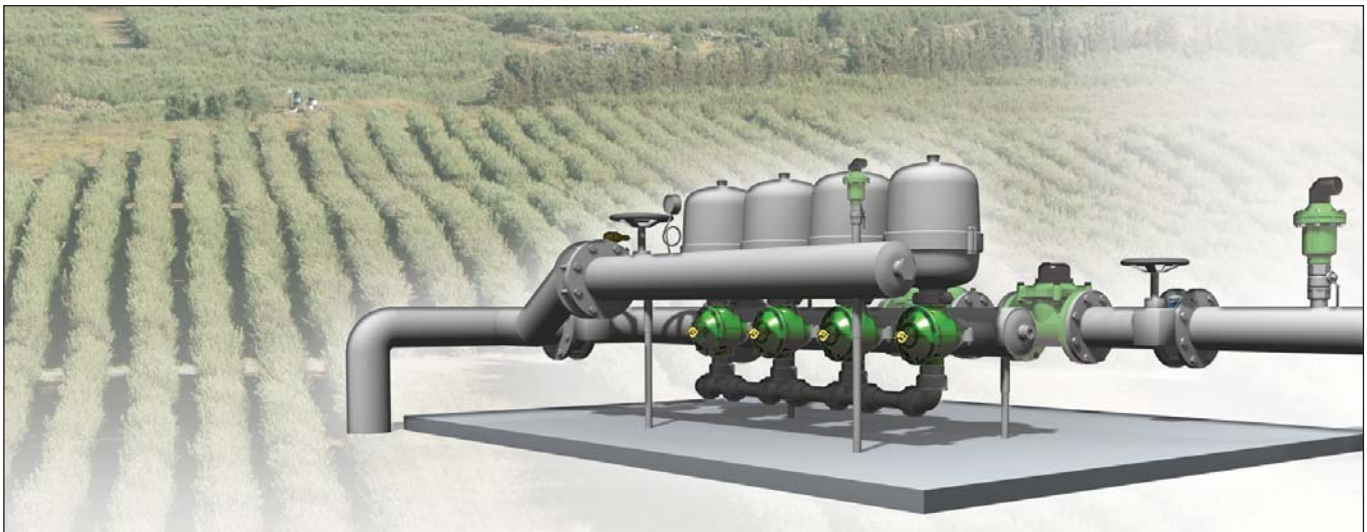
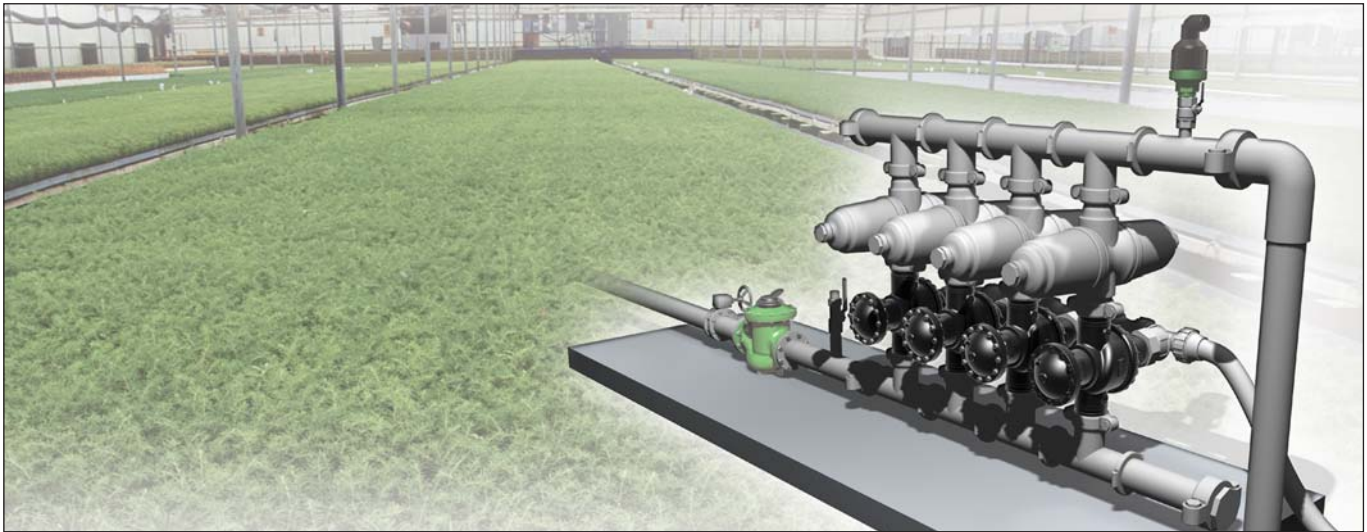

Typical Applications

- Automatic Backwash of Filter Batteries
 - Gravel Filters
 - Sand Filters
 - Disk Filters
 - Screen Filters
- Single Filter Autonomic Backwash System
- Angled or Straight Installations (IR-350 Series, Double Chamber Valves)
- Backwash Flow Limit (IR-470-beKU, IR-170-beU)

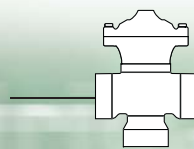

Angle Flow



Straight Flow

Filter Backwash Hydraulic BERMAD Valve, 2x2 Plastic

IR-2x2-350-P

The BERMAD Model IR-2x2-350-P is a compact 3-port valve, in a T configuration, constructed from reinforced plastic. It is a double chambered, hydraulically operated, and diaphragm actuated valve, designed for automatic backwashing of filters with 2" inlet and outlet ports. In response to a pressure rise command, its diaphragm actuated plug assembly closes the supply port drip tight, while opening the backwash port. The valve's short travel guarantees smooth flow direction changes, conserves water supply, prevents filter site flooding, and eliminates mixing of supply and waste water. The BERMAD Model IR-2x2-350-P is available in Angle flow (A) and Straight flow (S) configurations.



Angle Flow



Straight Flow

Filter Backwash Hydraulic BERMAD Valve, 2x2 Metal Body

IR-2x2-350-R

This 2x2 Filter Backwash Hydraulic Valve features a metal body, providing rigid construction. It is available in Angle flow (A) and Straight flow (S) configurations.



Angle Flow



Straight Flow

Filter Backwash Hydraulic BERMAD Valve, 3x3 Plastic

IR-3x3-350-P

This Double Chambered, Filter Backwash Hydraulic Valve suits filters with 3" Inlet and outlet Ports. It is available in Angle flow (A) and Straight flow (S) configurations.



Angle Flow



Straight Flow

Filter Backwash Hydraulic BERMAD Valve, 3x3 Metal Body

IR-3x3-350-I

This 3x3 Filter Backwash Hydraulic Valve features a metal body, providing rigid construction. It is available in Angle flow (A) and Straight flow (S) configurations.

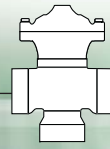

Filter Backwash Hydraulic BERMAD Valve, 4x3 Metal

IR-4x3-350-A-I

The BERMAD Model IR-4x3-350-A-I is a compact 3-port valve, in a T configuration. It is a hydraulically operated and diaphragm actuated valve, designed for automatic backwashing of filters with 4" inlet and outlet ports. In response to a pressure rise command, its diaphragm actuated plug assembly closes the supply port drip tight, while opening the backwash port. The valve's short travel guarantees smooth flow direction changes, conserves water supply, prevents filter site flooding, and eliminates mixing of supply and waste water. The valve's metal construction ensures a rigid, damage resistant valve.



Filter Backwash Hydraulic BERMAD Valve, 4x4 Metal

IR-4x4-350-A-I

This Filter Backwash Hydraulic Valve suits filters with 4" inlet and outlet ports and high backwash flow requirements.



Filter Backwash Flow Control BERMAD Valve

IR-470-beKU

The BERMAD Normally Open, Flow Control Valve is a line pressure driven control valve that controls filter backwash flow maintaining a preset maximum flow rate. It is commanded by a flow pilot, which senses the ΔP across an orifice installed upstream from the valve. The valve shuts in response to an external hydraulic pressure rise command.



Filter Backwash Flow Control BERMAD Valve

IR-I70-beU

This BERMAD Normally Open, Flow Control Valve is constructed of reinforced plastic.

Irrigation for Agriculture

Infield Head-Works



Located at the entrance from the supply network to the distribution lines and laterals, the **Infield Head-Works** serves as the system's final control of the water's actual enter the distribution lines. Including various types of electric or hydraulic on/off remote control valves, which combine a variety of features, the **Infield Head-Works**:

- Controls irrigation shifts, applying water metering abilities with outputs to the irrigation controller
- Maintains pre-designed system demand and pressure
- Establishes pressure zones, protecting the distribution lines and the laterals
- Differentiates irrigation regimes to meet changing crop stage
- Incorporates local fertilization arrangements and final filtration solutions

BERMAD Irrigation

Infield Head-Works

Infield Head-Works

-  Infield Head-Works
-  Hydrants Line

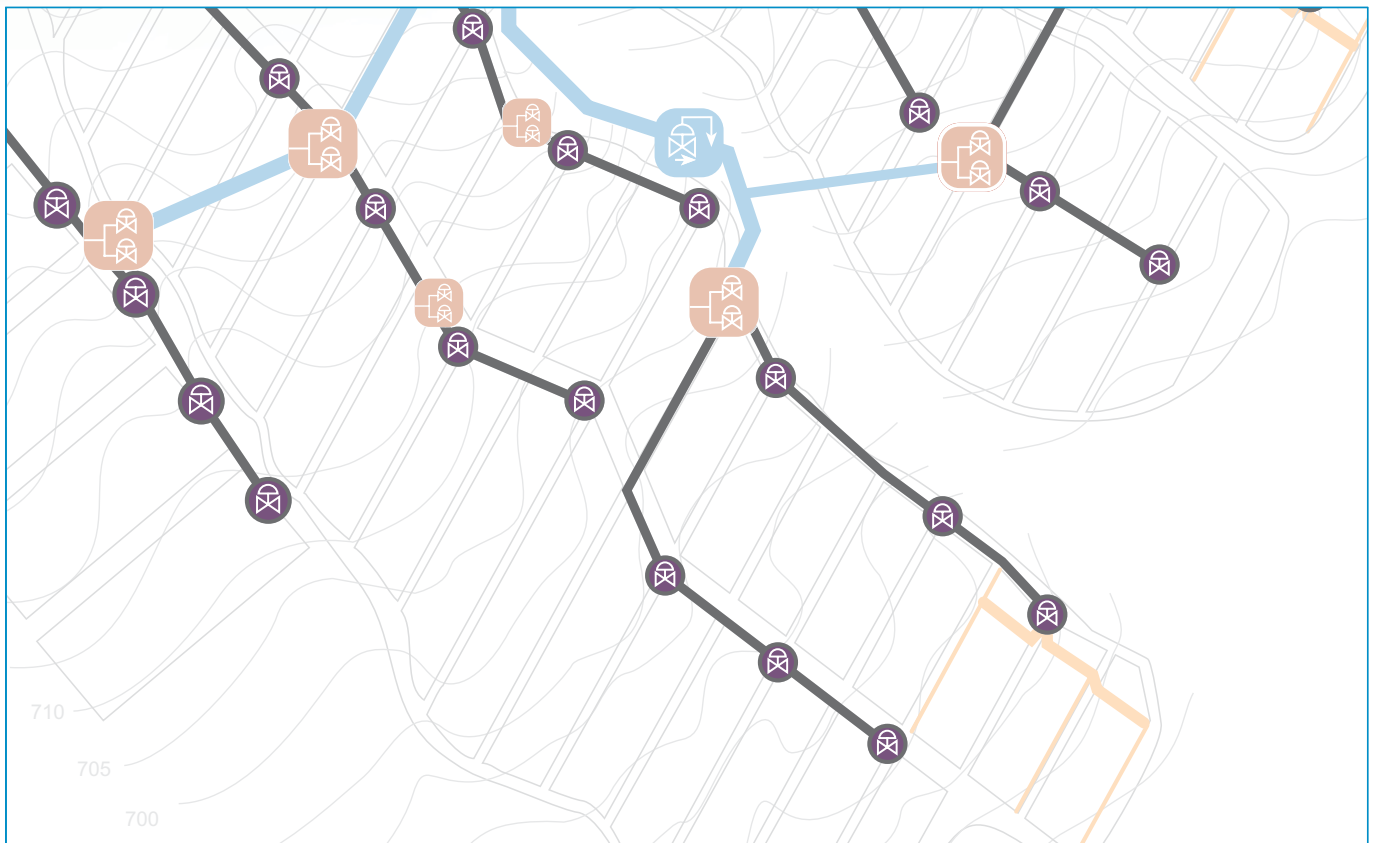
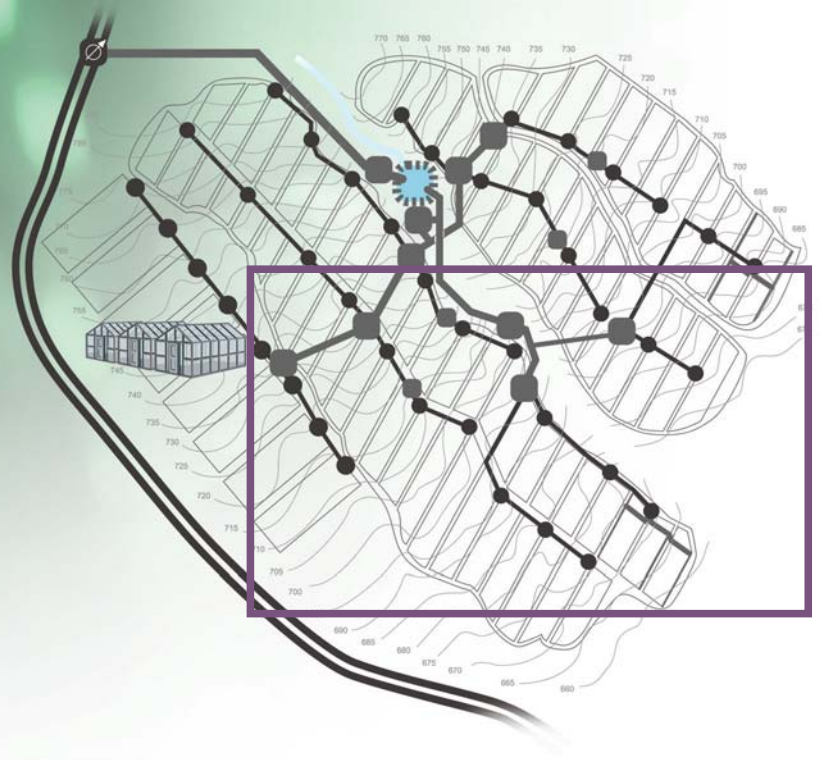

On/Off Control



Pressure Reducing, Standard



Pressure Reducing, Drip-Tape



Pressure Reducing & Sustaining

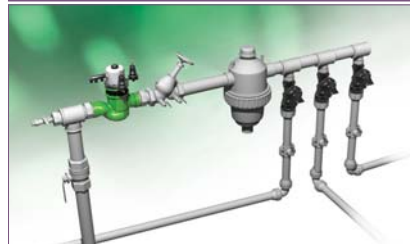

Pressure Sustaining



Flow Control



Flow Control & Pressure Reducing



On/Off Control Valves

On/Off Control Valves are hydraulically or electrically activated valves that can be locally or remotely triggered to open or close. Proper selection of valve types and normal position (Open or Closed), ensures meeting the design requirements of every control system and level.



Typical Applications:

- Computerized Irrigation Systems
- Manual Irrigation Systems Intended for Computerization
- Semi-Automatic Irrigation Systems (IR-900-D0, IR-900-DD)
- Remote and/or Elevated Systems (Additional Features 54 & 55)
- Remote Flow Monitoring & Leakage Control (IR-900-M0)

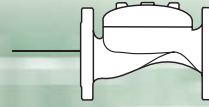

Hydraulic Control BERMAD Valve

IR-405-Z

The BERMAD Hydraulic Control Valve is a hydraulically operated, diaphragm actuated control valve that opens and shuts off in response to a local or remote pressure command.



Hydraulic Control BERMAD Valve, Normally Closed with Hydraulic Relay

IR-405-54-KX

This Normally Closed, line pressure driven hydraulic control valve opens in response to an external hydraulic pressure rise command and shuts in the absence of that command.



Solenoid Controlled BERMAD Valve

IR-410-KX

This Solenoid Controlled, line pressure driven, hydraulically operated valve, opens or shuts in response to an electric signal. The solenoid is compliant with the common controllers on the market and it features a manual override.

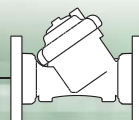

Hydraulic Control BERMAD Valve

IR-105-Z

The BERMAD Hydraulic Control Valve is a hydraulically operated, diaphragm actuated control valve that opens and shuts off in response to a local or remote pressure command.



Hydraulic Control BERMAD Valve, Normally Closed with Hydraulic Relay

IR-105-54-X

This Normally Closed, line pressure driven, hydraulic control valve opens in response to an external hydraulic pressure rise command and shuts in the absence of that command.



Solenoid Controlled BERMAD Valve

IR-110-X

This Solenoid Controlled, line pressure driven, hydraulically operated valve, opens and closes drip-tight in response to an electric signal. The solenoid is compliant with the common controllers on the market and it features a manual override.



Solenoid Controlled BERMAD Valve with 2-Way Internal Controls

IR-110-NI-2W

This 2-Way Solenoid Controlled, line pressure driven, hydraulically operated valve includes an internal hydraulic Feed & Bleed control loop. The valve opens and closes drip-tight in response to an electric signal, which causes the solenoid to open or close the valve's internal hydraulic loop. The solenoid is compliant with the common controllers on the market and it features a manual override.

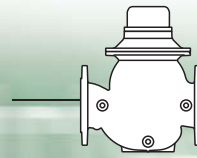

Hydrometer BERMAD with Magnetic Drive

IR-900-MO-Z

The BERMAD Hydrometer with Magnetic Drive integrates a vertical turbine Woltman-type water meter with a diaphragm actuated hydraulic control valve. The impeller drive is magnetically coupled to a vacuum-sealed meter register in the control head. Serving as Flow Meter and Main Valve, it controls system irrigation together with the irrigation controller. The Hydrometer opens and shuts in response to a local or remote pressure command.



Hydrometer BERMAD Magnetic Drive, Normally Closed with Hydraulic Relay

IR-900-MO-54-KX

This Normally Closed, line pressure driven Hydrometer with Magnetic Drive opens in response to an external hydraulic pressure rise command and shuts in the absence of that command.



Hydrometer BERMAD, Magnetic Drive with Solenoid Control

IR-910-KX

This Solenoid Controlled, line pressure driven Hydrometer with Magnetic Drive, opens or shuts in response to an electric signal. The solenoid is compliant with the common controllers on the market and it features a manual override.



Automatic Metering Valve (AMV) BERMAD

IR-900-DO

The BERMAD Automatic Metering Valve integrates a vertical turbine Woltman-type water meter with a diaphragm actuated hydraulic control valve. Equipped with a Mechanical Shut-Off Pilot, the BERMAD IR-900-DO enables volumetric irrigation in non-computerized systems. It automatically shuts itself off after accurately delivering a manually preset quantity of water.



Automatic Metering Valve (AMV) BERMAD for Sequential Irrigation

IR-900-DD

This BERMAD Automatic Metering Valve is equipped with a mechanical sequential shut-off pilot. When open it transmutes pressure to the Next AMV, closing it. When the AMV shuts itself, it allows the next AMV to open and deliver a manually preset quantity of water.

Working in a group of manually preset AMV's connected to each other by a control tube and operating in sequence, it enables semi-automatic irrigation in non-computerized systems.

Pressure Reducing Control Valves for Standard Systems

The transformation from the hydrants line into the lower grade distribution lines and laterals, requires over-pressure protection. Pressure Reducing Valves help accomplish this by reducing higher inlet pressure to a lower constant predetermined delivery pressure. They maintain pressure per system design in accordance with crop, irrigation equipment, location, elevation, etc.



Typical Applications:

- Pressure Reducing Systems
- Systems Subject to Varying Supply Pressure (3-Way Control)
- Distribution Centers
- Computerized Irrigation Systems
- Manual Irrigation Systems Intended for Computerization
- Semi-Automatic Irrigation Systems (IR-920-D0)
- Remote Flow Monitoring & Leakage Control (IR-920-M0)
- Remote and/or Elevated Systems (Additional Features 54 & 55)
- Greenhouse Irrigation Centers

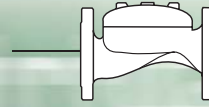

Pressure Reducing BERMAD Valve

IR-420-KXZ

IR-420-RXZ

The BERMAD Pressure Reducing Valve is a line pressure driven control valve that reduces higher upstream pressure to lower preset downstream pressure. The valve automatically opens fully upon pressure drop below setting. Its advanced globe, hydro-efficient design and fully supported and balanced diaphragm ensure an unobstructed flow path, excellent low-flow regulation performance, and trouble-free, long life operation. The Model IR-420-RXZ includes Metal Accessories.



Pressure Reducing BERMAD Valve with Hydraulic Control

IR-420-50-KXZ

IR-420-50-RXZ

This Normally Open, line pressure driven Pressure Reducing Valve shuts in response to an external hydraulic pressure rise command. The Model IR-420-50-RXZ includes Metal Accessories.



IR-420-54-KX

IR-420-54-3Q-KX

Pressure Reducing BERMAD Valve, Normally Closed with Hydraulic Relay

IR-420-54-KX

Pressure Reducing BERMAD Valve, Normally Closed with Relief Override

IR-420-54-3Q-KX

This Normally Closed, line pressure driven Pressure Reducing Valve opens in response to an external hydraulic pressure rise command, and shuts in the absence of that command. The model IR-420-54-3Q-KX Pressure Relief Override feature enables it to serve also as a Pressure Relief Valve, protecting the system even when in closed position.



IR-420-55-KX

IR-420-55-3Q-KX

Pressure Reducing BERMAD Valve with Solenoid Control

IR-420-55-KX

Pressure Reducing BERMAD Valve Solenoid Controlled with Relief Override

IR-420-55-3Q-KX

This Solenoid Controlled, line pressure driven Pressure Reducing Valve opens or shuts in response to an electric signal. The solenoid is compliant with the common controllers on the market and it features a manual override. The model IR-420-55-3Q-KX Pressure Relief Override feature enables it to serve also as a Pressure Relief Valve, protecting the system even when in closed position.

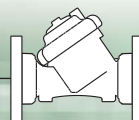

Pressure Reducing BERMAD Valve

IR-120-XZ

The BERMAD Pressure Reducing Valve is a line pressure driven control valve that reduces higher upstream pressure to lower preset downstream pressure. The valve automatically opens fully upon pressure drop below setting. Its engineered plastic industrial grade, hYflow 'Y' body with "look through" design and unitized Flexible Super Travel (FST) diaphragm and guided plug ensure superior durability with high chemical and cavitation resistance, ultra-high flow capacity, and accurate and stable regulation with smooth closing.



Pressure Reducing BERMAD Valve with Hydraulic Control

IR-120-50-XZ

This Normally Open, line pressure driven Pressure Reducing Valve shuts in response to an external hydraulic pressure rise command.



IR-120-54-X



IR-120-54-3Q-X

Pressure Reducing BERMAD Valve, Normally Closed with Hydraulic Relay

IR-120-54-X

Pressure Reducing BERMAD Valve, Normally Closed with Relief Override

IR-120-54-3Q-X

This Normally Closed, line pressure driven Pressure Reducing Valve opens in response to an external hydraulic pressure rise command, and shuts in the absence of that command.

The model IR-120-54-3Q-X Pressure Relief Override feature enables it to serve also as a Pressure Relief Valve, protecting the system even when in closed position.

Pressure Reducing BERMAD Valve with Solenoid Control

IR-120-55-X

Pressure Reducing BERMAD Valve Solenoid Controlled with Relief Override

IR-120-55-3Q-X



IR-120-55-X



IR-120-55-3Q-X

This Solenoid Controlled, line pressure driven Pressure Reducing Valve opens or shuts in response to an electric signal. The solenoid is compliant with the common controllers on the market and it features a manual override.

The model IR-120-55-3Q-X Pressure Relief Override feature enables it to serve also as a Pressure Relief Valve, protecting the system even when in closed position.

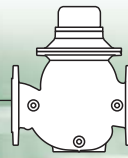

**Pressure Reducing
BERMAD Hydrometer,
Magnetic Drive**

IR-920-MO-KXZ

IR-920-MO-RXZ

The BERMAD Pressure Reducing Hydrometer integrates a vertical turbine Woltman-type water meter with a diaphragm actuated hydraulic control valve. Serving as Flow Meter and Main Valve, it controls irrigation together with the irrigation controller reducing higher upstream pressure to lower preset downstream pressure. The hydrometer automatically opens fully upon pressure drop below setting. The Model IR-920-MO-RXZ includes Metal Accessories.



**Pressure Reducing
BERMAD Hydrometer,
Magnetic Drive with Hydraulic Control**

IR-920-MO-50-KXZ

IR-920-MO-50-RXZ

This Normally Open, line pressure driven Pressure Reducing Hydrometer shuts in response to an external hydraulic pressure rise command. The Model IR-920-MO-50-RXZ includes Metal Accessories.



**Pressure Reducing
BERMAD Hydrometer,
Magnetic Drive,
Normally Closed with Hydraulic Relay**

IR-920-MO-54-KX

This Normally Closed, line pressure driven Pressure Reducing Hydrometer opens in response to an external hydraulic pressure rise command and shuts in the absence of that command.



**Pressure Reducing
BERMAD Hydrometer,
Magnetic Drive with Solenoid Control**

IR-920-MO-55-KX

This Solenoid Controlled, line pressure driven Pressure Reducing Hydrometer opens or shuts in response to an electric signal. The solenoid is compliant with the common controllers on the market and it features a manual override.



**Pressure Reducing
BERMAD Automatic
Metering Valve (AMV)**

IR-920-DO-KX

The BERMAD Pressure Reducing AMV integrates a vertical turbine Woltman-type water meter with a diaphragm actuated hydraulic control valve. Equipped with a Mechanical Shut-Off Pilot and a Pressure Reducing 3-Way Pilot, it reduces higher upstream pressure to lower preset downstream pressure, opens fully upon pressure drop below setting, and automatically shuts itself off after accurately delivering a manually preset quantity of water.

Pressure Reducing Valves for Drip-Tape Applications

The unique low pressure requirements and sensitivity of laterals in Drip-Tape projects demand special care in the selection and functioning of Pressure Reducing Valves. Equipped with Servo Pilot, BERMAD Pressure Reducing Valves for Drip-Tape Applications provide a very low set point (0.5 bar; 7 psi) and a dynamic integrated needle valve resulting in very high accuracy and pressure repeatability.



Typical Applications:

- Drip-Tape Systems
- Non-Compensated Drip Lines
- Low Set Pressure Applications
- Pressure Reducing Systems
- Systems Subject to Varying Supply Pressure
- Computerized Irrigation Systems
- Manual Irrigation Systems Intended for Computerization
- Semi-Automatic Irrigation Systems (IR-920-D0)
- Remote Flow Monitoring & Leakage Control (IR-920-M0)
- Remote and/or Elevated Systems
(Additional Features 54 & 55)

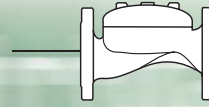

Pressure Reducing BERMAD Valve
For Drip-Tape Applications

IR-420-bKZ

IR-420-bRZ

The BERMAD Pressure Reducing Valve is a line pressure driven control valve that reduces higher upstream pressure to very low and stable preset downstream pressure. Its advanced globe hydro-efficient design, and fully supported and balanced diaphragm, ensure an unobstructed flow path, excellent low-flow regulation performance, and trouble-free long life operation. The Model IR-420-bRZ includes Metal Accessories.



Pressure Reducing BERMAD Valve with Hydraulic Control
For Drip-Tape Applications

IR-420-50-bKZ

IR-420-50-bRZ

This Normally Open, line pressure driven Pressure Reducing Valve shuts in response to an external hydraulic pressure rise command. The Model IR-420-50-bRZ includes Metal Accessories.



IR-420-54-bX



IR-420-54-3Q-bX

Pressure Reducing BERMAD Valve, Normally Closed with Hydraulic Relay
For Drip-Tape Applications

IR-420-54-bK

Pressure Reducing BERMAD Valve, Normally Closed with Relief Override
For Drip-Tape Applications

IR-420-54-3Q-bK

This Normally Closed, line pressure driven Pressure Reducing Valve opens in response to an external hydraulic pressure rise command, and shuts in the absence of that command. The model IR-420-54-3Q-bK Pressure Relief Override feature enables it to serve also as a Pressure Relief Valve, protecting the system even when in closed position.



IR-420-55-bX



IR-420-55-3Q-bX

Pressure Reducing BERMAD Valve with Solenoid Control
For Drip-Tape Applications

IR-420-55-bK

Pressure Reducing BERMAD Valve Solenoid Controlled with Relief Override
For Drip-Tape Applications

IR-420-55-3Q-bK

This Solenoid Controlled, line pressure driven Pressure Reducing Valve opens or shuts in response to an electric signal. The solenoid is compliant with the common controllers on the market and it features a manual override. The model IR-420-55-3Q-bK Pressure Relief Override feature enables it to serve also as a Pressure Relief Valve, protecting the system even when in closed position.

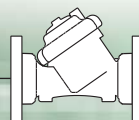

**Pressure Reducing
BERMAD Valve
For Drip-Tape Applications**

IR-120-bZ

The BERMAD Pressure Reducing Valve is a line pressure driven control valve that reduces higher upstream pressure to very low and stable preset downstream pressure. Its engineered plastic industrial grade, hYflow 'Y' body with "look through" design and unitized Flexible Super Travel (FST) diaphragm and guided plug excels in its highly durable chemical and cavitation resistance, ultra-high flow capacity, and accurate and stable regulation with smooth closing.



**Pressure Reducing
BERMAD Valve
with Hydraulic Control
For Drip-Tape Applications**

IR-120-50-bZ

This Normally Open, line pressure driven Pressure Reducing Valve shuts in response to an external hydraulic pressure rise command.

**Pressure Reducing
BERMAD Valve,
Normally Closed with Hydraulic Relay
For Drip-Tape Applications**

IR-120-54-b

**Pressure Reducing
BERMAD Valve,
Normally Closed with Relief Override
For Drip-Tape Applications**

IR-120-54-3Q-b



IR-120-54-b



IR-120-54-3Q-b

This Normally Closed, line pressure driven Pressure Reducing Valve opens in response to an external hydraulic pressure rise command, and shuts in the absence of that command.

The model IR-120-54-3Q-b Pressure Relief Override feature enables it to serve also as a Pressure Relief Valve, protecting the system even when in closed position.

**Pressure Reducing
BERMAD Valve
with Solenoid Control
For Drip-Tape Applications**

IR-120-55-b

**Pressure Reducing
BERMAD Valve
Solenoid Controlled with Relief Override
For Drip-Tape Applications**

IR-120-55-3Q-b



IR-120-55-b



IR-120-55-3Q-b

This Solenoid Controlled, line pressure driven Pressure Reducing Valve opens or shuts in response to an electric signal. The solenoid is compliant with the common controllers on the market and it features a manual override.

The model IR-120-55-3Q-b Pressure Relief Override feature enables it to serve also as a Pressure Relief Valve, protecting the system even when in closed position.

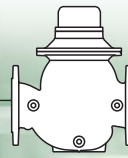

**Pressure Reducing
BERMAD Hydrometer,
Magnetic Drive For Drip-Tape Applications**

- IR-920-MO-bKZ
- IR-920-MO-bRZ

The BERMAD Pressure Reducing Hydrometer integrates a vertical turbine Woltman-type water meter with a diaphragm actuated hydraulic control valve. Serving as Flow Meter and Main Valve, it controls irrigation together with the irrigation controller, reducing higher upstream pressure to very low and stable preset downstream pressure. The Model IR-920-MO-bRZ includes Metal Accessories.



**Pressure Reducing
BERMAD Hydrometer,
Magnetic Drive with Hydraulic Control
For Drip-Tape Applications**

- IR-920-MO-50-bKZ
- IR-920-MO-50-bRZ

This Normally Open, line pressure driven Pressure Reducing Hydrometer shuts in response to an external hydraulic pressure rise command. The Model IR-920-MO-50-bRZ includes Metal Accessories.



**Pressure Reducing
BERMAD Hydrometer,
Magnetic Drive,
Normally Closed with Hydraulic Relay
For Drip-Tape Applications**

- IR-920-MO-54-bK

This Normally Closed, line pressure driven Pressure Reducing Hydrometer opens in response to an external hydraulic pressure rise command and shuts in the absence of that command.



**Pressure Reducing
BERMAD Hydrometer,
Magnetic Drive with Solenoid Control
For Drip-Tape Applications**

- IR-920-MO-55-bK

This Solenoid Controlled, line pressure driven Pressure Reducing Hydrometer opens or shuts in response to an electric signal. The solenoid is compliant with the common controllers on the market and it features a manual override.



**Pressure Reducing BERMAD
Automatic Metering Valve (AMV)
For Drip-Tape Applications**

- IR-920-DO-bK

The BERMAD Pressure Reducing AMV integrates a vertical turbine Woltman-type water meter with a diaphragm actuated hydraulic control valve. Equipped with a Mechanical Shut-Off Pilot and a Pressure Reducing Servo Pilot, it reduces higher upstream pressure to very low and stable preset downstream pressure, and automatically shuts itself off after accurately delivering a manually preset quantity of water.

Pressure Reducing & Sustaining Control Valves

The hydrants line is sometimes exposed to supply pressure drops due to system over-demand during unbalanced irrigation, line fill-up, filter backwash, etc. Pressure reducing and sustaining valves add a pressure sustaining feature to the standard pressure reducing valve, limiting the flow to sustain the minimum required supply pressure, while protecting irrigation systems downstream from the Infield Head-Works.

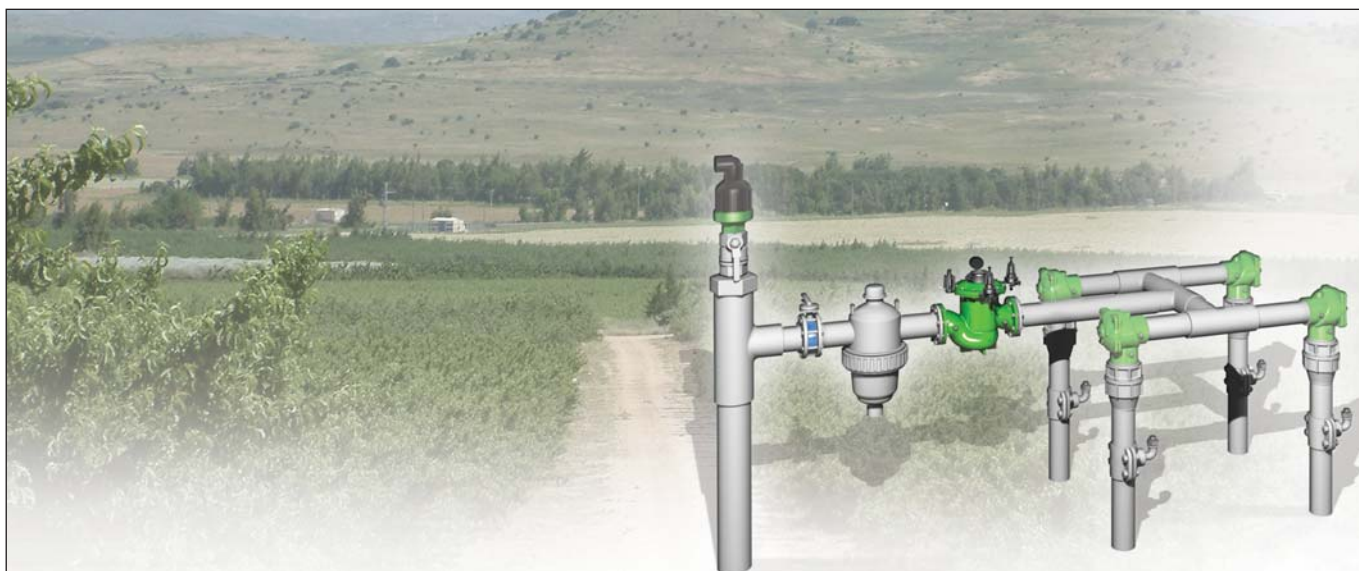

Typical Applications:

- Pressure Reducing Systems
- Line Fill-Up Control
- Line Emptying Prevention
- Distribution Centers
- Filter Stations
- Computerized Irrigation Systems
- Manual Irrigation Systems Intended for Computerization
- Semi-Automatic Irrigation Systems (IR-923-D0)
- Remote Flow Monitoring & Leakage Control (IR-923-M0)
- Remote and/or Elevated Systems (Additional Features 54 & 55)
- Greenhouse Irrigation Centers

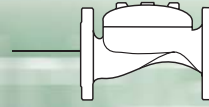

**Pressure Reducing & Sustaining
BERMAD Valve**

IR-423-KXZ

The BERMAD Pressure Reducing and Sustaining Valve is a line pressure driven control valve that sustains minimum preset upstream (back) pressure and reduces higher upstream pressure to lower preset downstream pressure. Its advanced globe hydro-efficient design and fully supported and balanced diaphragm ensure an unobstructed flow path, excellent low-flow regulation performance, and trouble-free long life operation.



**Pressure Reducing & Sustaining
BERMAD Valve,
Normally Closed with Hydraulic Relay**

IR-423-54-KX

This Normally Closed, line pressure driven Pressure Reducing and Sustaining Valve opens in response to an external hydraulic pressure rise command and shuts in the absence of that command.



**Pressure Reducing & Sustaining
BERMAD Valve
with Solenoid Control**

IR-423-55-KX

This Solenoid Controlled, line pressure driven Pressure Reducing and Sustaining Valve opens or shuts in response to an electric signal. The solenoid is compliant with the common controllers on the market and it features a manual override.



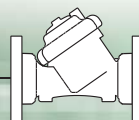

Pressure Reducing & Sustaining BERMAD Valve

IR-123-XZ

The BERMAD Pressure Reducing and Sustaining Valve is a line pressure driven control valve that sustains minimum preset upstream (back) pressure and reduces higher upstream pressure to lower preset downstream pressure. Its engineered plastic industrial grade, hYflow 'Y' body with "look through" design and unitized Flexible Super Travel (FST) diaphragm and guided plug excels in its highly durable chemical and cavitation resistance, ultra-high flow capacity, and accurate and stable regulation with smooth closing.



Pressure Reducing & Sustaining BERMAD Valve, Normally Closed with Hydraulic Relay

IR-123-54-X

This Normally Closed, line pressure driven Pressure Reducing and Sustaining Valve opens in response to an external hydraulic pressure rise command and shuts in the absence of that command.



Pressure Reducing & Sustaining BERMAD Valve with Solenoid Control

IR-123-55-X

This Solenoid Controlled, line pressure driven Pressure Reducing and Sustaining Valve opens or shuts in response to an electric signal. The solenoid is compliant with the common controllers on the market and it features a manual override. The Solenoid is compliant with the common controllers on the market and it features a manual override.

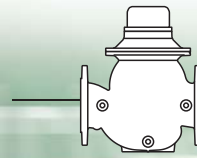

**Pressure Reducing & Sustaining
BERMAD Hydrometer
with Magnetic Drive**

IR-923-MO-KXZ

The BERMAD Pressure Reducing and Sustaining Hydrometer integrates a vertical turbine Woltman-type water meter with a diaphragm actuated hydraulic control valve. Serving as Flow Meter and Main Valve, it controls irrigation together with the irrigation controller. The Hydrometer sustains minimum preset upstream (back) pressure and reduces higher upstream pressure to lower preset downstream pressure. Its integrated “All-in-One” design saves space, cost and maintenance. The internal inlet and outlet flow straighteners save on straightening distances while maintaining accuracy.



**Pressure Reducing & Sustaining
BERMAD Hydrometer,
Magnetic Drive,
Normally Closed with Hydraulic Relay**

IR-923-MO-54-KX

This Normally Closed, line pressure driven Pressure Reducing and Sustaining Hydrometer opens in response to an external hydraulic pressure rise command and shuts in the absence of that command.



**Pressure Reducing & Sustaining
BERMAD Hydrometer,
Magnetic Drive with Solenoid Control**

IR-923-MO-55-KX

This Solenoid Controlled, line pressure driven Pressure Reducing and Sustaining Hydrometer opens or shuts in response to an electric signal. The solenoid is compliant with the common controllers on the market and it features a manual override.



**Pressure Reducing & Sustaining
BERMAD Automatic Metering Valve (AMV)**

IR-923-DO-KX

The BERMAD Pressure Reducing and Sustaining AMV integrates a vertical turbine Woltman-type water meter with a diaphragm actuated hydraulic control valve. Equipped with a Mechanical Shut-Off Pilot, a Pressure Reducing Pilot, and a Pressure Sustaining Pilot, it sustains minimum preset upstream (back) pressure, reduces higher upstream pressure to lower preset downstream pressure, and automatically shuts itself off after accurately delivering a manually preset quantity of water. It enables volumetric irrigation in non-computerized systems.

Pressure Sustaining Control Valves

Pressure Sustaining Valves sustain minimum back pressure, thus prioritizing pressure zones, preventing hydrants line emptying, controlling line fill-up, ensuring filter backwash pressure, etc.

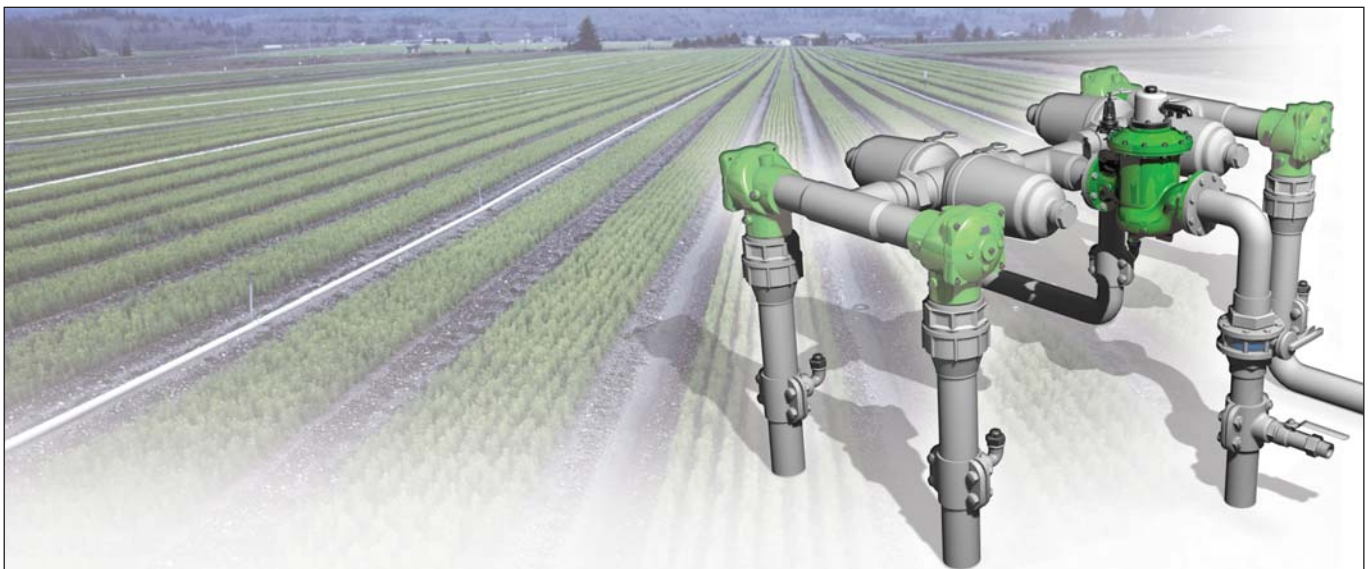

Typical Applications:

- Line Fill-Up Control
- Pressure Zone Prioritizing
- Line Emptying Prevention
- Infield Filter Backwash Pressure Sustaining
- Computerized Irrigation Systems
- Manual Irrigation Systems Intended for Computerization
- Semi-Automatic Irrigation Systems (IR-930-D0)
- Remote Flow Monitoring & Leakage Control (IR-930-M0)
- Remote and/or Elevated Systems (Additional Features 54 & 55)
- Greenhouse Irrigation Centers

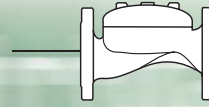

Pressure Sustaining BERMAD Valve

IR-430-KXZ

IR-430-RXZ

The BERMAD Pressure Sustaining Valve is a line pressure driven control valve that sustains minimum preset upstream (back) pressure and opens fully when line pressure is in excess of setting. Its advanced globe, hydro-efficient design, and fully supported and balanced diaphragm ensure an unobstructed flow path, excellent low-flow regulation performance, and trouble-free long life operation. The Model IR-430-RXZ includes Metal Accessories.



Pressure Sustaining BERMAD Valve with Hydraulic Control

IR-430-50-KXZ

IR-430-50-RXZ

This Normally Open, line pressure driven Pressure Sustaining Valve shuts in response to an external hydraulic pressure rise command. The Model IR-430-50-RXZ includes Metal Accessories.



Pressure Sustaining BERMAD Valve, Normally Closed with Hydraulic Relay

IR-430-54-KX

This Normally Closed, line pressure driven Pressure Sustaining Valve opens in response to an external hydraulic pressure rise command and shuts in the absence of that command.



Pressure Sustaining BERMAD Valve with Solenoid Control

IR-430-55-KX

This Solenoid Controlled, line pressure driven Pressure Sustaining Valve opens or shuts in response to an electric signal. The solenoid is compliant with the common controllers on the market and it features a manual override.

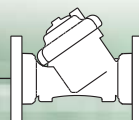

Pressure Sustaining BERMAD Valve

IR-130-XZ

The BERMAD Pressure Sustaining Valve is a line pressure driven control valve that sustains minimum preset upstream (back) pressure and opens fully when line pressure is in excess of setting. Its engineered plastic industrial grade, hYflow 'Y' body with "look through" design and unitized Flexible Super Travel (EST) diaphragm and guided plug excels in its highly durable chemical and cavitation resistance, ultra-high flow capacity, and accurate and stable regulation with smooth closing.



Pressure Sustaining BERMAD Valve, Normally Closed with Hydraulic Relay

IR-130-54-X

This Normally Closed, line pressure driven Pressure Sustaining Valve opens in response to an external hydraulic pressure rise command and shuts in the absence of that command.



Pressure Sustaining BERMAD Valve with Solenoid Control

IR-130-55-X

This Solenoid Controlled, line pressure driven Pressure Sustaining Valve opens or shuts in response to an electric signal. The solenoid is compliant with the common controllers on the market and it features a manual override.

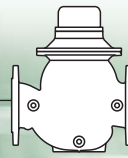

Pressure Sustaining BERMAD Hydrometer with Magnetic Drive

IR-930-MO-KXZ

The BERMAD Pressure Sustaining Hydrometer integrates a vertical turbine Woltman-type water meter with a diaphragm actuated hydraulic control valve. Serving as Flow Meter and Main Valve, it controls irrigation together with the irrigation controller. The Hydrometer sustains minimum preset upstream (back) pressure and opens fully when line pressure is in excess of setting. Its integrated "All-in-One" design saves space, cost and maintenance. The internal inlet and outlet flow straighteners save on straightening distances while maintaining accuracy.



Pressure Sustaining BERMAD Hydrometer, Magnetic Drive, Normally Closed with Hydraulic Relay

IR-930-MO-54-KX

This Normally Closed, line pressure driven Pressure Sustaining Hydrometer opens in response to an external hydraulic pressure rise command and shuts in the absence of that command.



Pressure Sustaining BERMAD Hydrometer, Magnetic Drive with Solenoid Control

IR-930-MO-55-KX

This Solenoid Controlled, line pressure driven Pressure Sustaining Hydrometer opens or shuts in response to an electric signal. The solenoid is compliant with the common controllers on the market and it features a manual override.



Pressure Sustaining BERMAD Automatic Metering Valve (AMV)

IR-930-DO-KX

The BERMAD Pressure Sustaining AMV integrates a vertical turbine Woltman-type water meter with a diaphragm actuated hydraulic control valve. Equipped with a Mechanical Shut-Off Pilot and a 3-Way Pressure Sustaining Pilot, it sustains minimum preset upstream (back) pressure, opens fully when line pressure is in excess of setting, and automatically shuts itself off after accurately delivering a manually preset quantity of water. It enables volumetric irrigation in non-computerized systems.

Flow Control Valves

Meters, filters, pumps and other distribution equipment might experience flows that exceed their operating capacity due to system over-demand during unbalanced irrigation, line fill-up, filter backwash, etc. Flow Control Valves maintain a preset maximum flow rate regardless of variations in demand or upstream/downstream pressure.



Typical Applications:

- Multiple Independent Consumer Systems
- Line Fill-Up Control
- Distribution Centers
- Computerized Irrigation Systems
- Manual Irrigation Systems Intended for Computerization
- Semi-Automatic Irrigation Systems (IR-970-D0)
- Remote Flow Monitoring & Leakage Control (IR-970-M0)
- Remote and/or Elevated Systems (Additional Features 54 & 55)
- Greenhouse Irrigation Centers

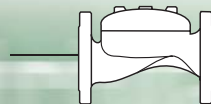

Flow Control BERMAD Valve with Hydraulic Control

IR-470-bKUZ

The BERMAD Flow Control Valve is a line pressure driven control valve that limits system demand to a constant preset maximum flow rate. It is commanded by a flow pilot, which senses the ΔP across an orifice installed upstream of the valve. Its advanced globe, hydro-efficient design and fully supported and balanced diaphragm ensure an unobstructed flow path, excellent low-flow regulation performance, and trouble-free long life operation.



Flow Control BERMAD Valve, Normally Closed with Hydraulic Relay

IR-470-54-bKU

This Normally Closed, line pressure driven Flow Control Valve opens in response to an external hydraulic pressure rise command and shuts in the absence of that command.



Flow Control BERMAD Valve with Solenoid Control

IR-470-55-bKU

This Solenoid Controlled, line pressure driven Flow Control Valve opens or shuts in response to an electric signal. The solenoid is compliant with the common controllers on the market and it features a manual override.

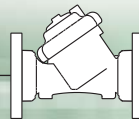

Flow Control BERMAD Valve

IR-I70-bDZ

The BERMAD Flow Control Valve is a line pressure driven control valve that limits system demand to a constant preset maximum flow rate. It is commanded by a flow pilot, which senses the ΔP across a Differential Pressure Duct installed in the valve. Its engineered plastic industrial grade, hYflow 'Y' body with "look through" design and unitized Flexible Super Travel (FST) diaphragm and guided plug excels in its highly durable chemical and cavitation resistance, ultra-high flow capacity, and accurate and stable regulation with smooth closing.



Flow Control BERMAD Valve, Normally Closed with Hydraulic Relay

IR-I70-54-bD

This Normally Closed, line pressure driven Flow Control Valve opens in response to an external hydraulic pressure rise command and shuts in the absence of that command.



Flow Control BERMAD Valve with Solenoid Control

IR-I70-55-bD

This Solenoid Controlled, line pressure driven Flow Control Valve opens or shuts in response to an electric signal. The solenoid is compliant with the common controllers on the market and it features a manual override.

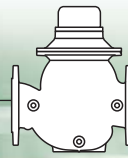

Flow Control BERMAD Hydrometer with Magnetic Drive

IR-970-MO-KVZ

The BERMAD Flow Control Hydrometer integrates a vertical turbine Woltman-type water meter, with a diaphragm actuated hydraulic control valve. Commanded by a paddle flow pilot, which includes a paddle positioned within the flow stream, it limits system demand to a constant preset maximum flow rate. Its integrated “All-in-One” design saves space, cost and maintenance. The internal inlet and outlet flow straighteners save on straightening distances while maintaining accuracy.



Flow Control BERMAD Hydrometer, Magnetic Drive, Normally Closed with Hydraulic Relay

IR-970-MO-54-KV

This Normally Closed, line pressure driven Flow Control Hydrometer opens in response to an external hydraulic pressure rise command and shuts in the absence of that command.



Flow Control BERMAD Hydrometer, Magnetic Drive with Solenoid Control

IR-970-MO-55-KV

This Solenoid Controlled, line pressure driven Flow Control Hydrometer opens or shuts in response to an electric signal. The solenoid is compliant with the common controllers on the market and it features a manual override.



Flow Control BERMAD Automatic Metering Valve (AMV)

IR-970-DO-KV

The BERMAD Flow Control AMV integrates a vertical turbine Woltman-type water meter with a diaphragm actuated hydraulic control valve. Equipped with a Mechanical Shut-Off Pilot and a paddle flow pilot, which includes a paddle positioned within the flow stream, it limits system demand to a constant preset maximum flow rate and automatically shuts itself off after accurately delivering a manually preset quantity of water. It enables volumetric irrigation in non-computerized systems.

Flow Control & Pressure Reducing Valves

Flow Control Valves maintain system preset maximum flow rate, preventing flows from exceeding the designed flow rates caused by system over-demand during unbalanced irrigation, line fill-up, etc. **Flow Control and Pressure Reducing Valves** add a pressure reducing feature to the standard Flow Control Valve, preventing system over-demand while protecting irrigation systems downstream from the Infield Head-Works.

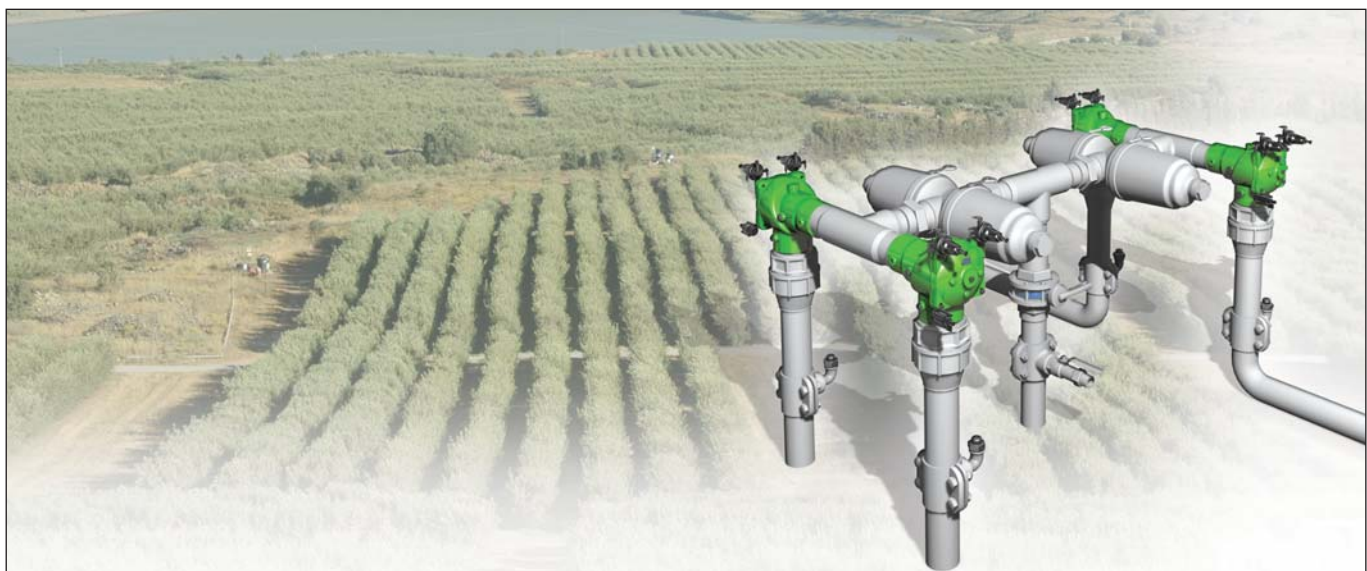

Typical Applications:

- Multiple Independent Consumer Systems
- Pressure Reducing Systems
- Line Fill-Up Control
- Distribution Centers
- Computerized Irrigation Systems
- Manual Irrigation Systems Intended for Computerization
- Semi-Automatic Irrigation Systems (IR-972-D0)
- Remote Flow Monitoring & Leakage Control (IR-972-M0)
- Remote and/or Elevated Systems (Additional Features 54 & 55)
- Greenhouse Irrigation Centers

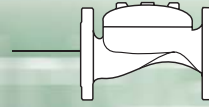

**Flow Control & Pressure Reducing
BERMAD Valve**

IR-472-bKUZ

The BERMAD Flow Control and Pressure Reducing Valve is a line pressure driven control valve that limits system demand and reduces downstream pressure to constant preset maximum values. Its advanced globe hydro-efficient design and fully supported and balanced diaphragm ensure an unobstructed flow path, excellent low-flow regulation performance, and trouble-free long life operation.



**Flow Control & Pressure Reducing
BERMAD Valve,
Normally Closed with Hydraulic Relay**

IR-472-54-bKU

This Normally Closed, line pressure driven Flow Control and Pressure Reducing Valve opens in response to an external hydraulic pressure rise command and shuts in the absence of that command.



**Flow Control & Pressure Reducing
BERMAD Valve
with Solenoid Control**

IR-472-55-bKU

This Solenoid Controlled, line pressure driven Flow Control and Pressure Reducing Valve opens or shuts in response to an electric signal. The solenoid is compliant with the common controllers on the market and it features a manual override.

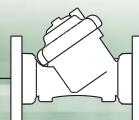

Flow Control & Pressure Reducing BERMAD Valve

IR-172-bDZ

The BERMAD Flow Control and Pressure Reducing Valve is a line pressure driven control valve that limits system demand and reduces downstream pressure to constant preset maximum values. Its engineered plastic industrial grade, hYflow 'Y' body with "look through" design and unitized Flexible Super Travel (FST) diaphragm and guided plug excels in its highly durable chemical and cavitation resistance, ultra-high flow capacity, and accurate and stable regulation with smooth closing.



Flow Control & Pressure Reducing BERMAD Valve, Normally Closed with Hydraulic Relay

IR-172-54-bD

This Normally Closed, line pressure driven Flow Control and Pressure Reducing Valve opens in response to an external hydraulic pressure rise command and shuts in the absence of that command.



Flow Control & Pressure Reducing BERMAD Valve with Solenoid Control

IR-172-55-bD

This Solenoid Controlled, line pressure driven Flow Control and Pressure Reducing Valve opens or shuts in response to an electric signal. The solenoid is compliant with the common controllers on the market and it features a manual override.

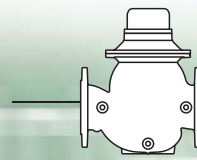

**Flow Control & Pressure Reducing
BERMAD Hydrometer
with Magnetic Drive**

IR-972-MO-KVZ

The BERMAD Flow Control and Pressure Reducing Hydrometer integrates a vertical turbine Woltman-type water meter, with a diaphragm actuated hydraulic control valve. It limits system demand and reduces downstream pressure to constant preset maximum values. Its integrated “All-in-One” design saves space, cost and maintenance. The internal inlet and outlet flow straighteners save on straightening distances while maintaining accuracy.



**Flow Control & Pressure Reducing
BERMAD Hydrometer,
Magnetic Drive,
Normally Closed with Hydraulic Relay**

IR-972-MO-54-KV

This Normally Closed, line pressure driven Flow Control and Pressure Reducing Hydrometer opens in response to an external hydraulic pressure rise command and shuts in the absence of that command.



**Flow Control & Pressure Reducing
BERMAD Hydrometer,
Magnetic Drive with Solenoid Control**

IR-972-MO-55-KV

This Solenoid Controlled, line pressure driven Flow Control and Pressure Reducing Hydrometer opens or shuts in response to an electric signal. The solenoid is compliant with the common controllers on the market and it features a manual override.



**Flow Control & Pressure Reducing
BERMAD Automatic Metering Valve (AMV)**

IR-972-DO-KV

The BERMAD Flow Control and Pressure Reducing AMV integrates a vertical turbine Woltman-type water meter with a diaphragm actuated hydraulic control valve. Equipped with a Mechanical Shut-Off Pilot, a paddle flow pilot and a Pressure Reducing Pilot, it limits system demand and reduces downstream pressure to constant preset maximum values, and automatically shuts itself off after accurately delivering a manually preset quantity of water. It enables volumetric irrigation in non-computerized systems.

Irrigation for Agriculture

Infield System

Systems irrigated by non-compensated emitters, systems with high elevation differential, systems with turbid water, systems including sloppy margins, and so on, require additional control before being applied directly to the distribution lines. Some of the most common components in the **Infield System** are:

- Pressure Reducers for maintaining constant supply flow and protecting laterals
- Pressure Reducing Valves for distribution lines requiring additional reduction to compensate for steep slopes
- Pressure Reducing On/Off Valves for complex plots with multiple zones to control
- Flush-'n-Stop Valves for flushing the distribution line at the beginning and end of each shift
- Anti-Drain Valves to prevent line emptying and maintain irrigation uniformity in blocks with sloppy margins

BERMAD Irrigation

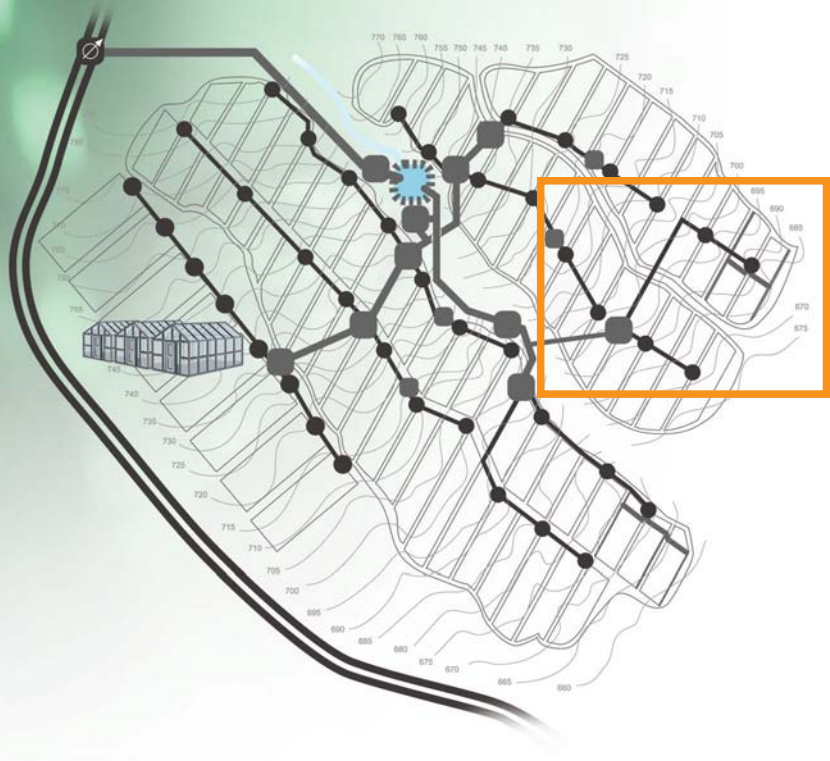

Infield System

- Distribution Line
- Laterals

Infield System

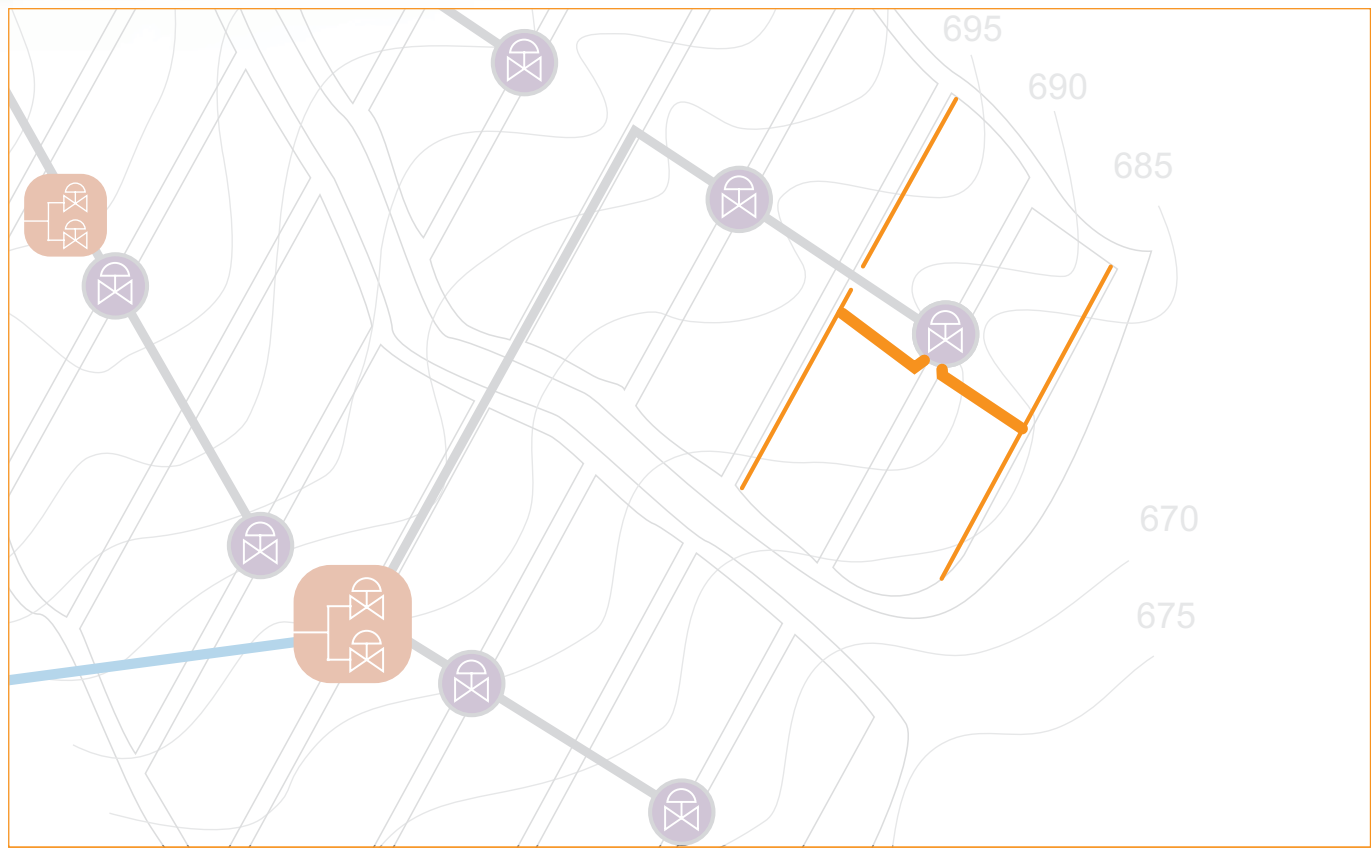

Pressure Reducing



Anti-Drain



Flush-'n-Stop

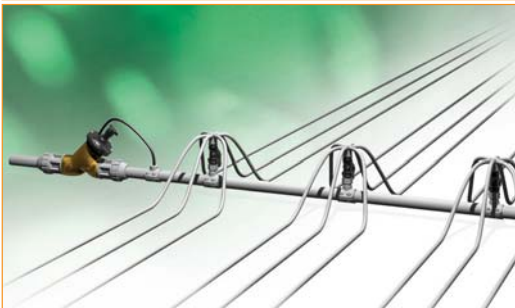

Pressure Reducing for Infield Systems

Non-compensated irrigation emitters and drip-tape laterals often require a means of final pressure reduction, compensating for elevation differences and line friction, and providing laterals with burst protection. Direct acting pressure reducers and pressure reducing valves provide simple and cost effective solutions for this purpose.



Typical Applications:

- Non-Compensating Drip-Line Flow Fixation
- Lateral Final Burst Protection
- Primary PRV for High ΔP Pressure Reducing Systems
- Secondary Protection of Sensitive Lines
- Pressure Zoning in Topographic Areas
- Pressure Reduction for Marginal Plots
- Distribution Line Lateral Risers (PRV Series)
- Irrigation Machine Sprinkler Flow Control (PRV Series)
- Single Sprinkler Flow Fixation (PRV Series)

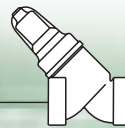

3/4"-PRV



3/4"-PRV-05
Low-Flow

Adjustable Direct Acting BERMAD Plastic Pressure Reducers

3/4"-PRV

3/4"-PRV-05

The BERMAD Adjustable Direct Acting Pressure Reducer is actuated by a pressure responsive diaphragm, which seeks to reach equilibrium between hydraulic and set spring force. The BERMAD Mode 3/4"-PRV is built of reinforced plastic that endows it with excellent hydraulic performance capabilities and high mechanical strength. It reduces higher upstream pressure to lower constant downstream pressure regardless of fluctuating demand or varying upstream pressure. The Model 3/4"-PRV-05 is supplied with a special throttling plug and elastomeric seal, and reduces pressure even under conditions of near zero demand.



1"-PRV



1"-PRV-05
Low-Flow

Adjustable Direct Acting BERMAD Plastic Pressure Reducer

1"-PRV

1"-PRV-05

This BERMAD Adjustable Direct Acting Pressure Reducer suits Flow Range of 0.45-7 m³/h; 2-31 gpm. The Model 1"-PRV-05 is supplied with a special throttling plug and elastomeric seal, and suits Flow Ranges of 0.1-7 m³/h; 0.4-31 gpm



Adjustable Direct Acting BERMAD Metal Pressure Reducer

1 1/2"-PRV

This BERMAD Adjustable Direct Acting Pressure Reducer has a brass body and reinforced plastic actuator assembly, which endow it with particularly high mechanical strength. It is supplied with a special throttling plug and elastomeric seal. It reduces pressure even under conditions of near zero demand, and seals drip-tight under no-flow conditions. It suits Flow Ranges of 0.45-18 m³/h; 2-80 gpm.



Direct Acting BERMAD Metal Pressure Reducer with Manual Closure

2"-PRV

This BERMAD Direct Acting Pressure Reducer has a brass body and reinforced plastic actuator assembly, which endow it with excellent hydraulic performance capabilities and particularly high mechanical strength. Supplied with a special throttling plug, it reduces higher upstream pressure to lower constant downstream pressure even under conditions of near zero demand, and seals drip-tight under no-flow conditions.

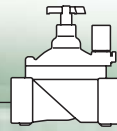

Pressure Reducing BERMAD Valve For Drip-Tape Applications

IR-220-bZ

The BERMAD Pressure Reducing Valve is a line pressure driven control valve that reduces higher upstream pressure to very low and stable preset downstream pressure. Equipped with a Servo Pilot, the BERMAD Pressure Reducing Valve for Drip-Tape Applications provides a very low set point (0.5 bar; 7 psi) and a dynamic integrated needle valve resulting in very low hysteresis.

Its plastic globe, hydro-efficient design, and fully supported and balanced unitized diaphragm and guided plug excel in its highly durable chemical and cavitation resistance, and accurate and stable regulation with smooth closing.



Pressure Reducing BERMAD Valve with Solenoid Control For Drip-Tape Applications

IR-220-55-b

This Solenoid Controlled, line pressure driven Pressure Reducing Valve opens or shuts in response to an electric signal. The solenoid is compliant with the common controllers on the market and it features a manual override.

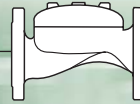

**Pressure Reducing BERMAD Valve
For Drip-Tape Applications**

GR-420-bKZ

The BERMAD Pressure Reducing Valve is a line pressure driven control valve that reduces higher upstream pressure to very low and stable preset downstream pressure. Equipped with a Servo Pilot, the BERMAD Pressure Reducing Valve for Drip-Tape Applications provides a very low set point (0.5 bar; 7 psi) and dynamic integrated needle valve resulting in very low hysteresis. Its advanced globe, hydro-efficient design, and fully supported and balanced diaphragm ensure an unobstructed flow path, excellent low-flow regulation performance, and trouble-free long life operation.



**Pressure Reducing BERMAD Valve
with Solenoid Control
For Drip-Tape Applications**

GR-420-55-bK

This Solenoid Controlled, line pressure driven Pressure Reducing Valve opens or shuts in response to an electric signal. The solenoid is compliant with the common controllers on the market and it features a manual override.

Anti-Drain Valves

Line emptying or fill-up have a damaging effect on irrigation lines and equipment, and on irrigation uniformity.

Anti-drain valves prevent line emptying when installed at the beginning of plain plot sloppy margins or on risers from downhill distribution lines or irrigation machines. The main distribution line is then remain under low pressure preventing damage from line emptying or fill-up, and enabling all areas of the plot to start/stop irrigation simultaneously, thereby contributing to irrigation uniformity.



Typical Applications:

- Plain Plots with Sloppy Margins
- Downhill Sprinkler Lines
- Hillside Irrigation Machines



Anti-Drain BERMAD Valve

IR-205-05

The BERMAD Anti-Drain Valve is a spring loaded, diaphragm actuated valve that opens upon pressurizing the irrigation system and shuts off drip-tight when the system reaches closure pressure. Maintained pressure is determined by the valve's auxiliary closing spring force.



Anti-Drain BERMAD Valve

GR-405-05

The BERMAD Anti-Drain Valve is a spring loaded diaphragm actuated valve that opens upon pressurizing the irrigation system and shuts off drip-tight when the system reaches closure pressure. Maintained pressure is determined by the valve's auxiliary closing spring force.

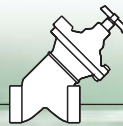

Flush-'n-Stop Valves

Automatic flushing of distribution lines at the beginning and end of each irrigation cycle helps prevent dirt from accumulating at the end of the line, where flow velocity is low. This reduces the risk of emitters clogging, resulting in more uniformity and less maintenance.



Typical Applications:

- Distribution Line Flush-'n-Stop
 - Drip Systems
 - Sprinklers & Micro-Sprinklers
 - Greenhouses
- Flooding Tables Drainage (with External Pressure)
- Irrigation Machine Line Flush-'n-Stop



Flush-'n-Stop BERMAD Valve

IR-300-eLMO

The BERMAD Flush-'n-Stop Valve is a double chambered, hydraulically operated, diaphragm actuated control valve. Equipped with an auxiliary opening spring and a flow stem, it enables automatic opening when the system reaches closure pressure and settable opening rate, ensuring line pressure build-up for secure closing.

Irrigation for Agriculture

Engineering Data

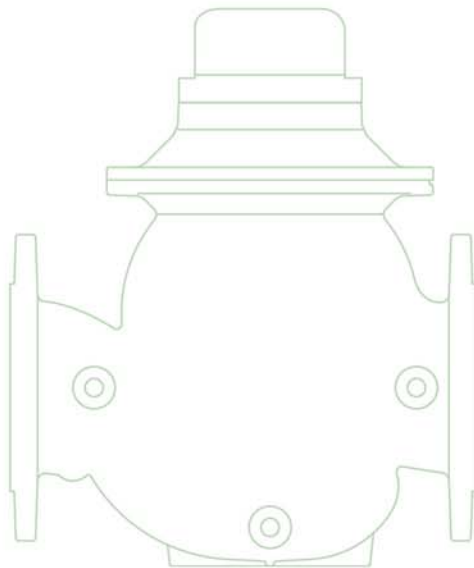
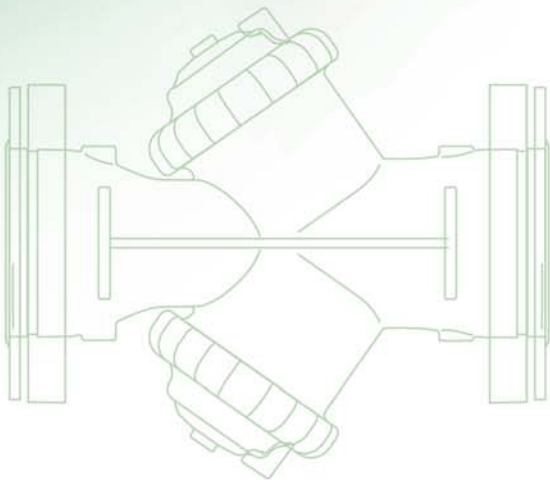
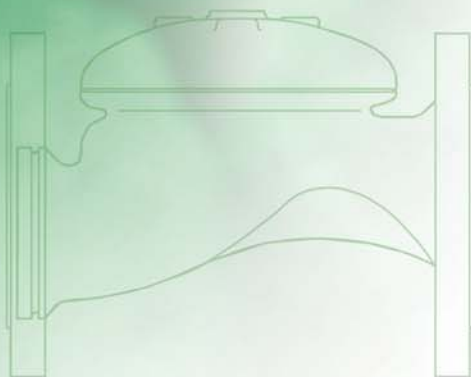

Engineering Data



Irrigation for Agriculture

Engineering Data

- IR-400 Series page 100-109
- IR-100 Series page 110-116
- IR-900-M Series page 117-130
- IR-900-D Series page 131-140
- WW-700 Series page 141-152
- Water Meters page 153-158
- IR-350 Series page 159-163
- IR-200 Series page 164-168
- IR-300 Series page 169-172
- IR-R00 Series page 173-176
- PRV Series page 177-181
- AR Series page 182-186

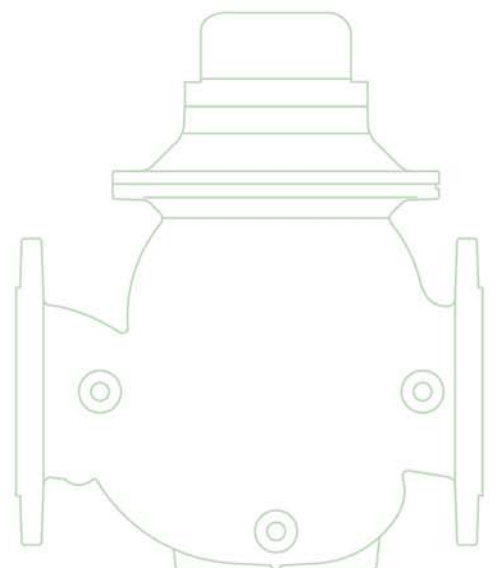
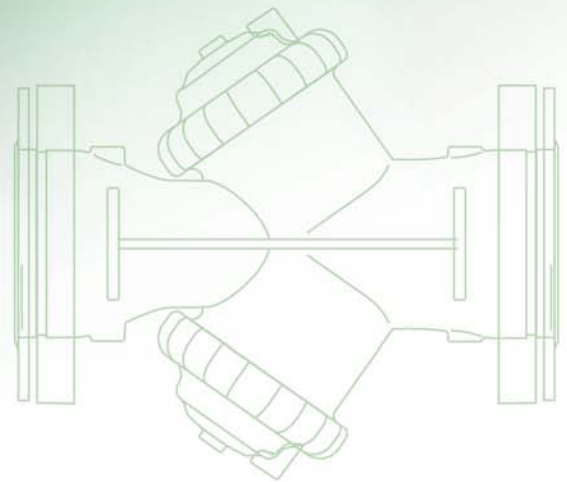
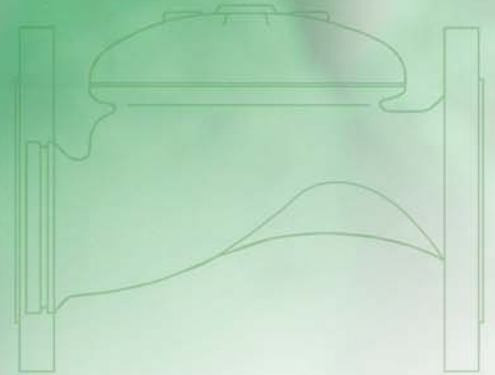

Irrigation for Agriculture

Engineering Data

IR-400 Series

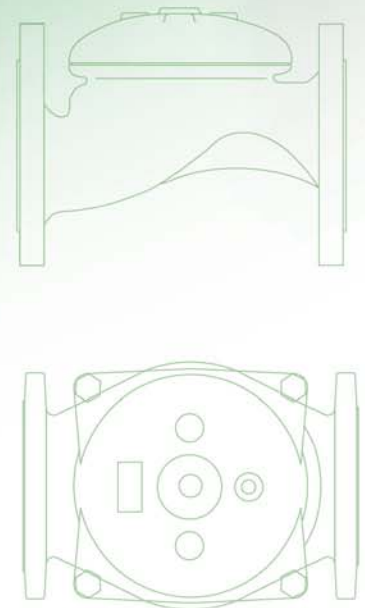
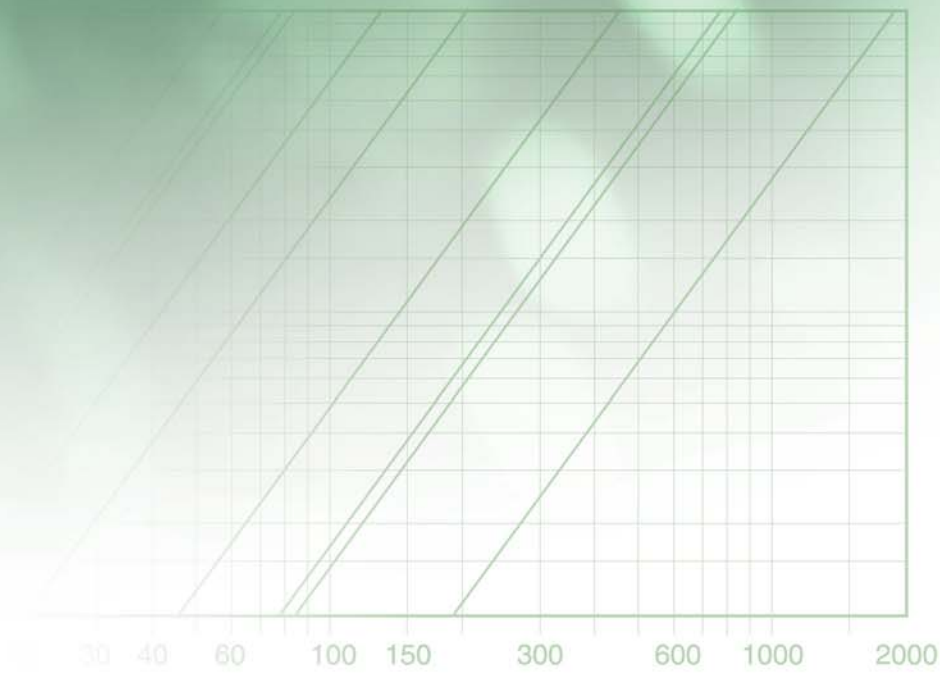

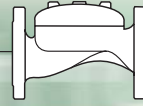

Product Parts Features

[1] Fastening Bolts

Only four bolts (up to 10"; DN250 valve) fasten valve cover to body, ensuring quick in-line inspection and service.

[2] Valve Cover

Locates, centralizes and fastens diaphragm and spring ensuring smooth and accurate performance. Simple construction enables quick in-line inspection and service.

[3] Auxiliary Closing Spring

One single spring fully meets valve requirements for operating pressure range, ensuring low opening pressure and secured closing.

[4] Diaphragm Assembly

One piece elastomeric assembly that includes a peripherally supported flexible diaphragm, vulcanized with a rugged radial seal disk.

- No need for special types of diaphragms to meet different operating conditions.
- Progressive dynamic guidance, resulting in exceptionally stable action and restrained closing.
- Valve opens and closes drip tight even with very low pressure supply.
- Perfectly balanced diaphragm with no distortion caused by uneven hydraulic forces on shut-off or during regulation.
- Exceptionally stable and chatter-free action during shut-off and pressure regulation.

[5] Body Threads

No need for nuts, simplifying valve disassembling and assembling for maintenance.

[6] Wide Body Valve

Hydro-dynamically designed for efficient flow with minimal pressure loss and excellent resistance to cavitation.

[6.1] Diaphragm Supporting & Guiding

[6.2] Diaphragm Balancing Chamber

[6.3] Valve Seat: Full bore, valve port area clear of obstructions; no ribs or stem guides. Flow entrance is vertical to seal disk.

[6.4] End Connections: Conforms to pressure ratings and standards of: ISO, ANSI, JIS, BS, and others.

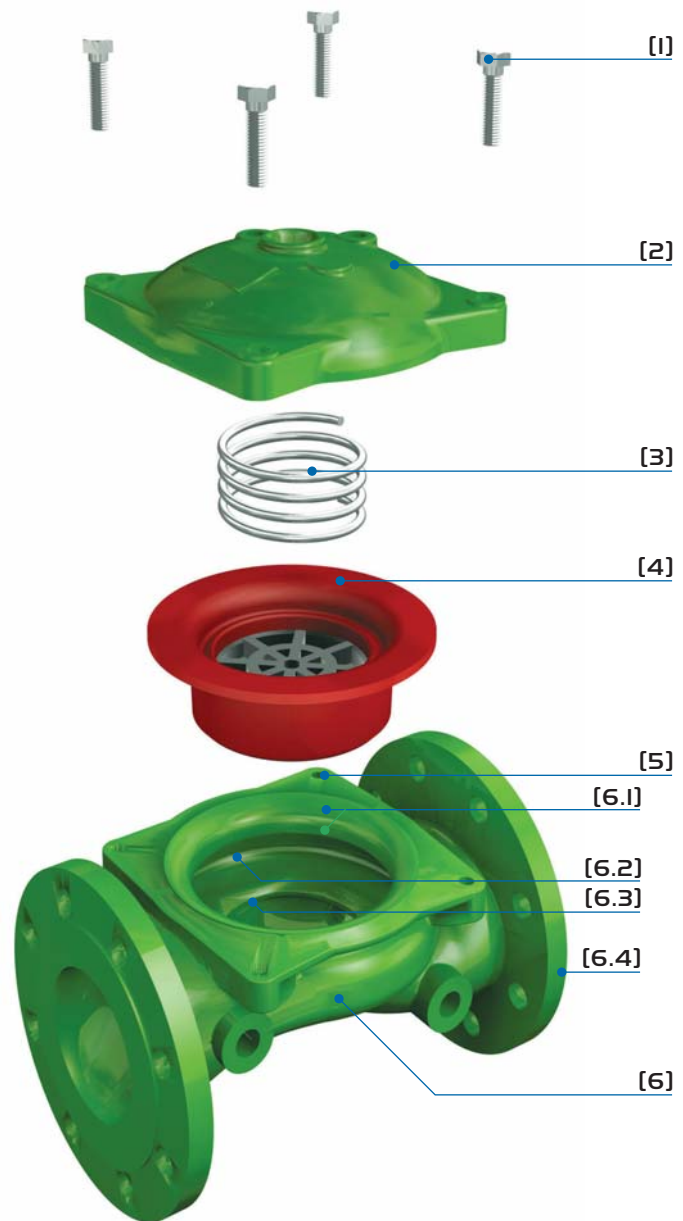

For spare parts ordering, Please use BERMAD "Spare Parts Ordering Guide"

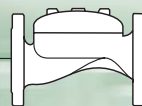

Technical Data



Construction Materials

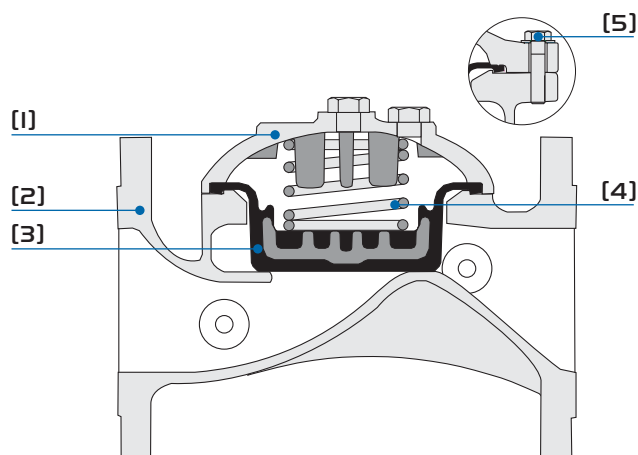

Description	GR-400	IR-400			
Size	DN20-50	DN40-150	DN200	DN250-400	DN50-100
Pattern	Globe	Globe	Globe	Globe	Angle
Cover [1]	Brass	Cast Iron	Cast Iron	Ductile Iron	Cast Iron
Valve Body [2]	Brass	Cast Iron ⁽¹⁾	Cast Iron ⁽¹⁾	Ductile Iron	Cast Iron
Diaphragm Assembly [3]	NR with Plastic VRSD ⁽²⁾	NR with Plastic VRSD ⁽²⁾	NR with Plastic VRSD ⁽²⁾		NR with Plastic VRSD ⁽²⁾
Spring [4]	St. St. 302	Stainless Steel 302			
External Bolts [5]	St. St. 304	Zinc-Cobalt Plated Steel			
Coating	Un-Coated	Polyester Green RAL 6017			
Pressure Rating	PN10	PN16			

(1) DN100 & 150 grooved valves are constructed of Ductile Iron
 (2) Vulcanized Radial Seal Disk

Technical Specifications

Available Patterns, Size & End Connections

Connections	GR-400				IR-400			
	DN20	DN25	DN40	DN50	DN40	DN50	DN65	DN80R
Threaded	G	G	G	G	G	G & A	G & A	G & A
Flanged						G & A	G	G
Grooved						G		

Connections	IR-400							
	DN80	DN100	DN150	DN200	DN250	DN300	DN350	DN400
Threaded	G & A							
Flanged	G & A	G & A	G	G	G	G	G	G
Grooved	G & A	G & A	G					

G = Globe, A = Angle 90°

Connections Standard:

Flanged: ISO 7005-2 (PN10 & 16)
 Threaded: Rp ISO 7/1 (BSP.P) or NPT
 Grooved: ANSI C606

Operating Pressure Ranges:

IR-400: 0.5-16 bar
 For lower pressure requirements, consult factory
 GR-400: 0.5-10 bar

Temperature: Water up to 60°C

Standard Materials:

- Castings & Forgings:
 - Cast Iron to EN 1561
 - Ductile Iron to EN 1563
 - Brass
 - Plasti: Polyamid 6+30% GF
- Elastomers: NR to EN 681-1
- Coatings: Electrostatic Powder Coating Polyester

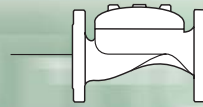

Dimensions & Weights



Globe Pattern

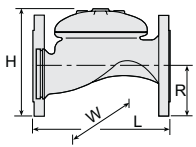

Size	Flanged										
	DN50	DN65	DN80R	DN80	DN100	DN150	DN200	DN250	DN300	DN350	DN400
L (mm)	205	205	210	250	320	415	500	605	725	742	742
H (mm)	155	178	200	210	242	345	430	460	635	655	965
W (mm)	155	178	200	200	223	306	365	405	580	587	600
R (mm)	78	89	100	100	112	140	170	202	242	260	300
Weight (kg)	9	10.5	12.1	19	28	68	125	140	290	358	377

Size	Threaded					Grooved			
	DN40	DN50	DN65	DN80R	DN80	DN50	DN80	DN100	DN150
L (mm)	153	180	210	210	255	205	250	320	415
H (mm)	87	114	132	140	165	108	155	191	302
W (mm)	98	119	129	129	170	119	170	204	306
R (mm)	29	39	45	53	55	31	46	61	85
Weight (kg)	2	4	5.7	5.8	13	5	10.6	16.2	49

Angle Pattern

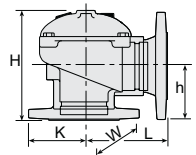

Size	Threaded				Grooved		Flanged		
	DN50	DN65	DN80R	DN80	DN80	DN100	DN50	DN80	DN100
L (mm)	86	110	110	110	120	160	121	153	160
H (mm)	136	180	178	184	194	223	160	205	223
W (mm)	119	131	131	170	170	204	155	200	223
h (mm)	61	93	91	80	90	112	83	101	112
K (mm)	56	66	66	55	45	58	78	100	112
Weight (kg)	4.4	5.8	7	11	10	16	9	17	26

Globe Pattern GR-400

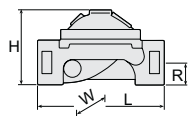

Size	DN20	DN25	DN40	DN50
L (mm)	112	115	150	180
H (mm)	68	70	89	103
W (mm)	22	23	32	39
R (mm)	72	72	94	118
Weight (kg)	0.95	0.95	1.5	4

Control Chamber Displacement Volume (liter)

DN50	DN65	DN80	DN100	DN150	DN200	DN250	DN300-400
0.113	0.179	0.291	0.668	1.973	3.858	3.858	13.75

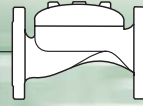

Flow Charts



Globe Pattern

2-Way circuit "Added Head Loss"
(for "V" below 2 m/s): 0.3 bar

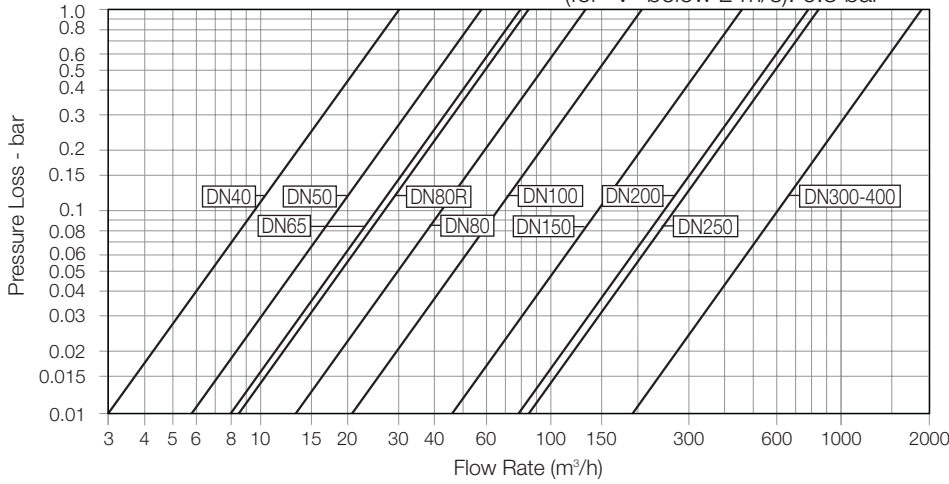

Angle Pattern

2-Way circuit "Added Head Loss"
(for "V" below 2 m/s): 0.3 bar

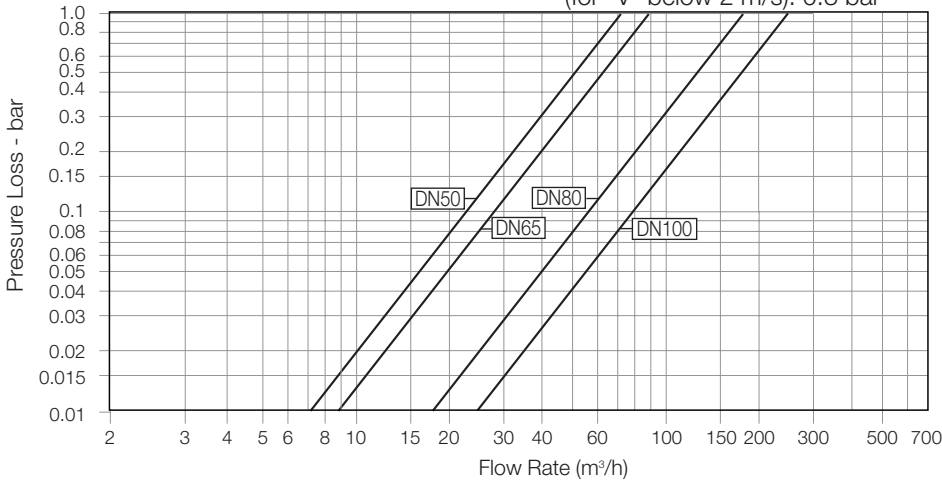

Globe Pattern GR-400

2-Way circuit "Added Head Loss"
(for "V" below 2 m/s): 0.3 bar

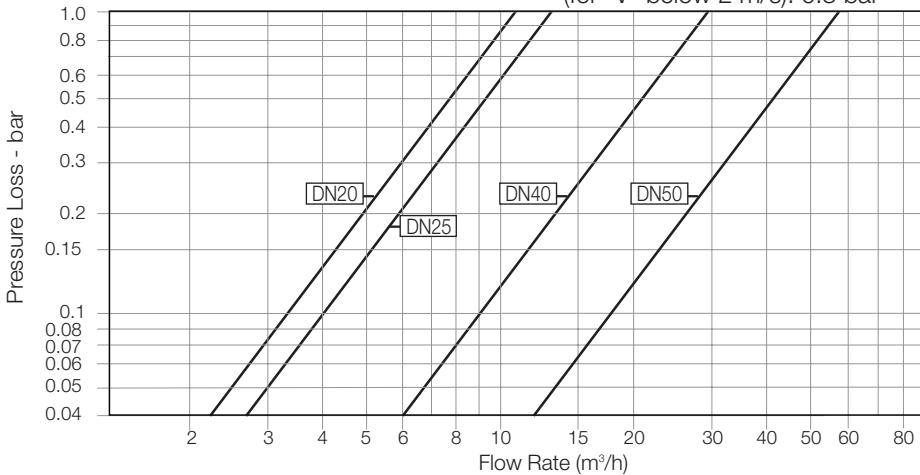

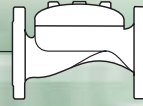

Flow Properties

SI Metric

		Size	DN50	DN65	DN80	DN100	DN150	DN200	DN250	DN300-400
Globe Pattern		Kv	57	78	136	204	458	781	829	1,932
		K	3.2	4.2	2.9	4.0	4.0	4.4	3.9	3.6
		Leq - m	9.1	12.1	13.7	14	27.4	45.8	108	57

Valve flow coefficient, Kv or Cv

$$Kv(Cv) = Q \sqrt{\frac{Gf}{\Delta P}}$$

Where:

Kv = Valve flow coefficient (flow in m³/h at 1 bar Diff. Press.)

Cv = Valve flow coefficient (flow in gpm at Diff. Press. 1 psi)

Q = Flow rate (m³/h ; gpm)

ΔP = Differential pressure (bar ; psi)

Gf = Liquid specific gravity (Water = 1.0)

$$Cv = 1.155 Kv$$

Equivalent Pipe Length, Leq

$$Leq = Lk \cdot D$$

Where:

Leq = Equivalent nominal pipe length (m ; feet)

Lk = Equivalent length coefficient for turbulent flow in clean commercial steel pipe (SCH 40)

D = Nominal pipe diameter (m ; feet)

Note:

The Leq values given are for general consideration only.

Flow resistance or Head loss coefficient,

$$K = \Delta H \frac{2g}{V^2}$$

Where:

K = Flow resistance or Head loss coefficient (dimensionless)

ΔH = Head loss (m ; feet)

V = Nominal size flow velocity (m/sec ; feet/sec.)

g = Acceleration of gravity (9.81 m/sec² ; 32.18 feet/sec²)

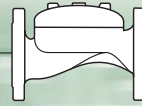

Technical Data



Construction Materials

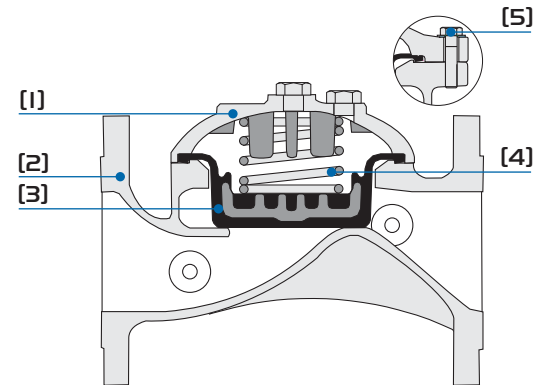

Description	GR-400		GR-400			
	3/4-3"	1 1/2-6"	8"	10-16"	2-4"	
Pattern	Globe	Globe	Globe	Globe	Angle	
Cover [1]	Brass	Cast Iron	Cast Iron	Ductile Iron	Cast Iron	
Valve Body [2]	Brass	Cast Iron ⁽¹⁾	Cast Iron ⁽¹⁾	Ductile Iron	Cast Iron	
Diaphragm Assembly [3]	NR with Plastic VRSD ⁽²⁾	NR with Plastic VRSD ⁽²⁾	NR with Cast Iron VRSD ⁽²⁾		NR with Plastic VRSD ⁽²⁾	
Spring [4]	St. St. 302	Stainless Steel 302				
External Bolts [5]	St. St. 304	Zinc-Cobalt Plated Steel				
Coating	Un-Coated	Polyester Green RAL 6017				
Pressure Rating	150 psi	230 psi				

(1) 4 & 6" grooved valves are constructed of Ductile Iron
 (2) Vulcanized Radial Seal Disk

Technical Specifications

Available Patterns, Size & End Connections

Connections	GR-400				IR-400			
	3/4"	1"	1 1/2"	2"	1 1/2"	2"	2 1/2"	3"R
Threaded	G	G	G	G	G	G & A	G & A	G & A
Flanged						G & A	G	G
Grooved						G		

Connections	IR-400							
	3"	4"	6"	8"	10"	12"	14"	16"
Threaded	G & A							
Flanged	G & A	G & A	G	G	G	G	G	G
Grooved	G & A	G & A	G					

G = Globe, A = Angle 90°

Connections Standard:

Flanged

■ ANSI B16.41 (Cast Iron)

■ ANSI B16.42 (Ductile Iron)

Threaded: NPT or Rp ISO 7/1 (BSP.P)

Grooved: ANSI C606

Operating Pressure Ranges:

IR-400: 7-232 psi

For lower pressure requirements, consult factory

GR-400: 7-150 psi

Temperature: Water up to 140°F

Standard Materials:

■ Castings & Forgings:

□ Cast Iron to ASTM A-126 Class B

□ Ductile Iron to ASTM A-536

□ Brass

□ Plastic: Polyamid 6+30% GF

■ Elastomers: NR to ASTM-D-2000

■ Coatings: Electrostatic Powder Coating Polyester

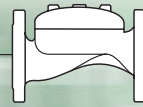

Dimensions & Weights



Globe Pattern

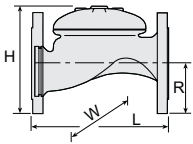

Size	Flanged										
	2"	2 1/2"	3"R	3"	4"	6"	8"	10"	12"	14"	16"
L (inch)	8 ^{1/16}	8 ^{1/16}	8 ^{1/4}	9 ^{13/16}	12 ^{5/8}	16 ^{5/16}	19 ^{11/16}	23 ^{13/16}	28 ^{9/16}	29 ^{1/4}	29 ^{1/4}
H (inch)	6 ^{1/8}	7	7 ^{7/8}	8 ^{1/4}	9 ^{1/2}	13 ^{9/16}	16 ^{15/16}	18 ^{1/8}	25	25 ^{13/16}	38
W (inch)	6 ^{1/8}	7	7 ^{7/8}	7 ^{7/8}	8 ^{3/4}	12	14 ^{3/8}	15 ^{15/16}	22 ^{7/8}	23 ^{1/8}	23 ^{5/8}
R (inch)	3 ^{1/16}	3 ^{1/2}	3 ^{15/16}	3 ^{15/16}	4 ^{1/2}	5 ^{1/2}	6 ^{11/16}	7 ^{15/16}	9 ^{1/2}	10 ^{1/4}	11 ^{13/16}
Weight (lb)	19.8	23.1	41.9	41.9	61.7	149.9	275.6	308.6	639.3	789.2	831.1

Size	Threaded					Grooved				
	1 1/2"	2"	2 1/2"	3"R	3"	2"	3"	4"	6"	
L (inch)	6	7 ^{1/16}	8 ^{1/4}	8 ^{1/4}	10	8 ^{1/16}	9 ^{13/16}	12 ^{5/8}	16 ^{5/16}	
H (inch)	3 ^{3/8}	4 ^{16/16}	5 ^{3/16}	5 ^{1/2}	6 ^{1/2}	4 ^{1/4}	6 ^{1/16}	7 ^{1/2}	15 ^{7/8}	
W (inch)	3 ^{7/8}	4 ^{11/16}	5 ^{1/16}	5 ^{1/16}	6 ^{11/16}	4 ^{11/16}	6 ^{11/16}	8	12 ^{1/16}	
R (inch)	1 ^{1/8}	1 ^{1/2}	1 ^{13/16}	2 ^{1/16}	2 ^{3/16}	1 ^{3/16}	1 ^{6/8}	2 ^{3/8}	3 ^{3/8}	
Weight (lb)	4.4	8.8	12.6	12.8	28.7	11.0	23.4	35.7	108.0	

Angle Pattern

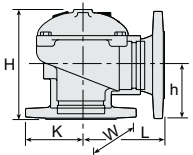

Size	Threaded				Grooved		Flanged		
	2"	2 1/2"	3"R	3"	3"	4"	2"	3"	4"
L (inch)	3 ^{3/8}	4 ^{5/16}	4 ^{5/16}	4 ^{3/8}	4 ^{3/4}	6 ^{5/16}	4 ^{3/4}	6	6 ^{1/4}
H (inch)	5 ^{3/8}	7 ^{1/16}	7	7 ^{1/4}	7 ^{5/8}	8 ^{3/4}	6 ^{5/16}	8 ^{1/16}	8 ^{3/4}
W (inch)	4 ^{11/16}	5 ^{3/16}	5 ^{3/16}	6 ^{11/16}	6 ^{11/16}	8	6 ^{1/8}	7 ^{7/8}	8 ^{3/4}
h (inch)	2 ^{3/8}	3 ^{11/16}	3 ^{9/16}	3 ^{1/8}	3 ^{9/16}	4 ^{1/2}	3 ^{1/4}	4	4 ^{7/16}
K (inch)	2 ^{3/16}	2 ^{5/8}	2 ^{5/8}	2 ^{3/16}	1 ^{3/4}	2 ^{5/16}	3 ^{1/16}	3 ^{15/16}	4 ^{7/16}
Weight (lb)	9.7	12.8	15.4	24.3	22.0	35.3	19.8	37.5	57.3

Globe Pattern GR-400

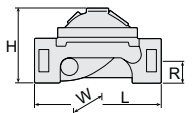

Size	3/4"	1"	1 1/2"	2"
L (inch)	4 ^{7/16}	4 ^{1/2}	5 ^{7/8}	7 ^{1/8}
H (inch)	2 ^{11/16}	2 ^{3/4}	3 ^{1/2}	4 ^{1/16}
W (inch)	7/8	1 ^{5/16}	1 ^{1/4}	1 ^{9/16}
R (inch)	2 ^{13/16}	2 ^{13/16}	3 ^{11/16}	4 ^{5/8}
Weight (lb)	2.1	2.1	3.3	8.8

Control Chamber Displacement Volume (gallons)

2"	2 1/2"	3"	4"	6"	8	10"	12-16"
0.03	0.05	0.08	0.18	0.52	1.02	1.02	3.63

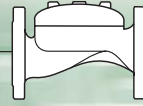

Flow Charts

US English

Globe Pattern

2-Way circuit "Added Head Loss"
(for "V" below 6.5 f/s): 4.5 psi

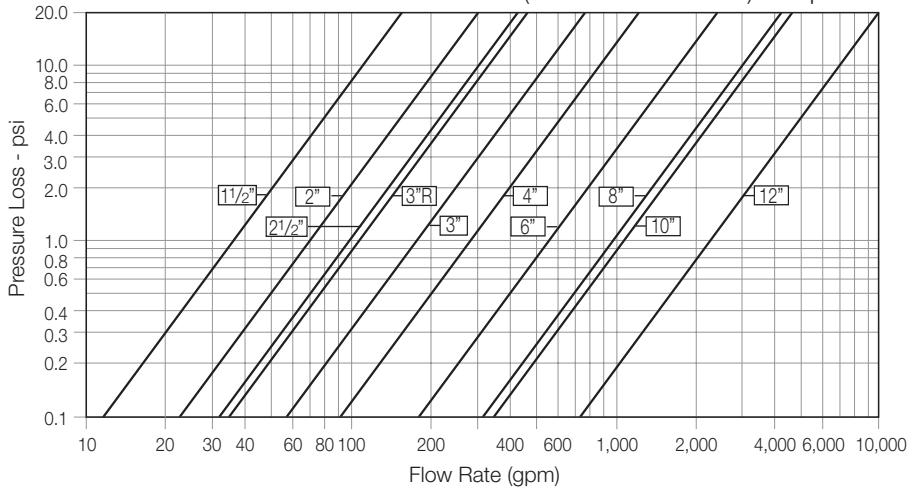

Angle Pattern

2-Way circuit "Added Head Loss"
(for "V" below 6.5 f/s): 4.5 psi

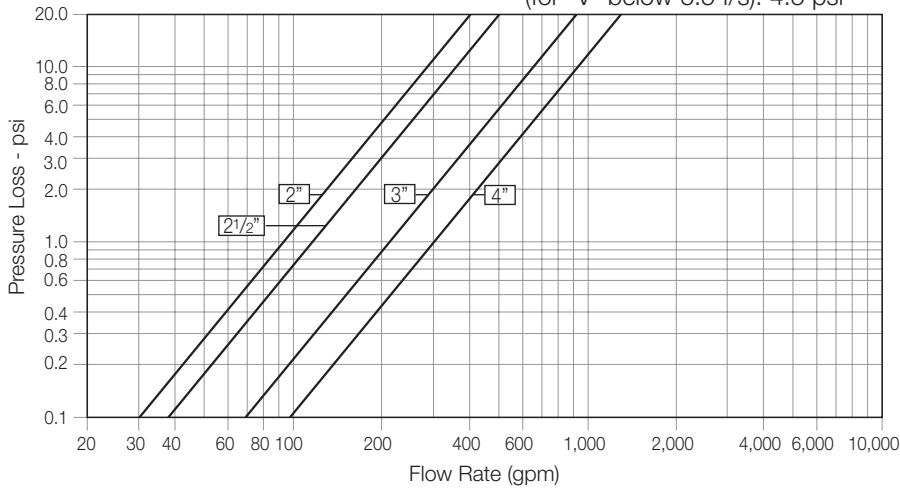

Globe Pattern GR-400

2-Way circuit "Added Head Loss"
(for "V" below 6.5 f/s): 4.5 psi

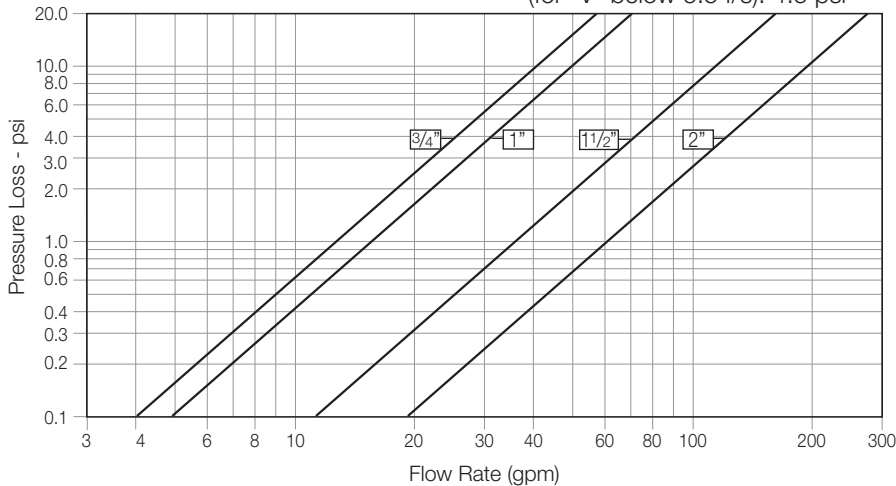

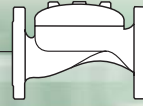

Flow Properties

US English

		2"	2 1/2"	3"	4"	6"	8"	10"	12-16"
Globe Pattern 	Cv	66	90	157	236	529	902	957	2,231
	K	3.2	4.2	2.9	4.0	4.0	4.4	3.9	3.6
	Leq - ft	30	40	45	46	90	150	354	187

Valve flow coefficient, Kv or Cv

$$K_v(C_v) = Q \sqrt{\frac{G_f}{\Delta P}}$$

Where:

Kv = Valve flow coefficient (flow in m³/h at 1bar Diff. Press.)

Cv = Valve flow coefficient (flow in gpm at Diff. Press. 1psi)

Q = Flow rate (m³/h ; gpm)

ΔP = Differential pressure (bar ; psi)

Gf = Liquid specific gravity (Water = 1.0)

$$C_v = 1.155 K_v$$

Equivalent Pipe Length, Leq

$$Leq = L_k \cdot D$$

Where:

Leq = Equivalent nominal pipe length (m ; feet)

Lk = Equivalent length coefficient for turbulent flow in clean commercial steel pipe (SCH 40)

D = Nominal pipe diameter (m ; feet)

Note:

The Leq values given are for general consideration only.

Flow resistance or Head loss coefficient,

$$K = \Delta H \frac{2g}{V^2}$$

Where:

K = Flow resistance or Head loss coefficient (dimensionless)

ΔH = Head loss (m ; feet)

V = Nominal size flow velocity (m/sec ; feet/sec.)

g = Acceleration of gravity (9.81 m/sec² ; 32.18 feet/sec²)

Irrigation for Agriculture

Engineering Data

IR-100 Series

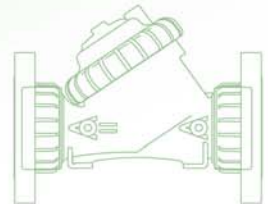
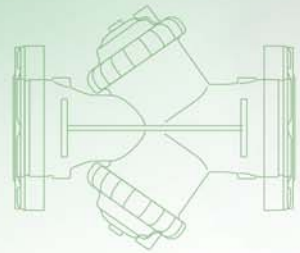
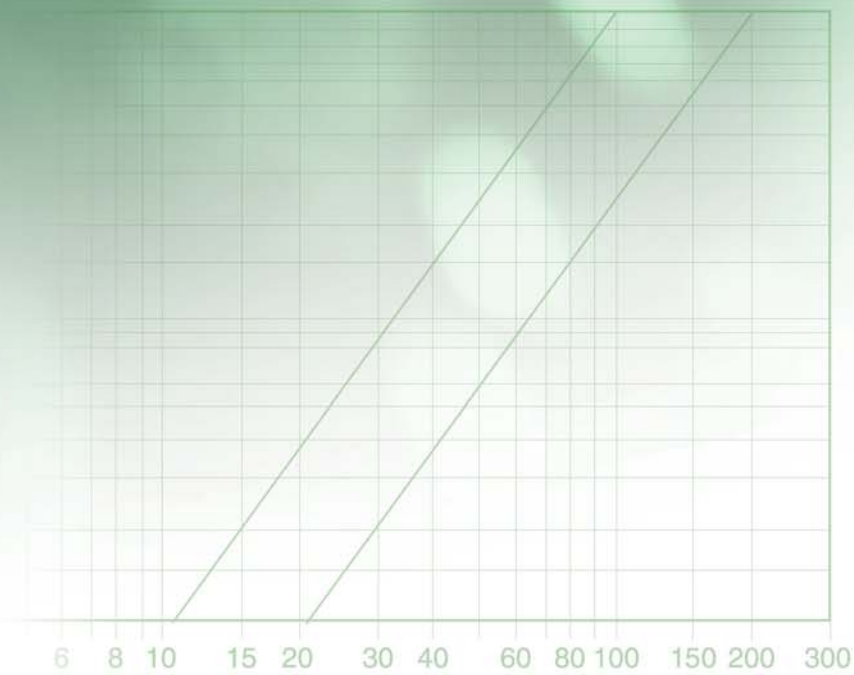

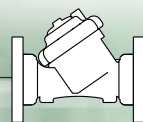

Product Parts Features

[1] **Cover Ring**

The cover ring fastens valve cover to body, stiffening and strengthening the valve body, enabling simple maintenance. A cover ring wrench is available.

[2] **"Click-In" Bracket**

For all BERMAD plastic accessories.

[3] **Valve Cover**

The cover's strong construction meets rough service conditions. Optional cover types (3"; DN80 and smaller valves) are capable of accepting a Flow Stem, a Flow Stem + Position Indicator, and a 2-Way Solenoid (2W-N1 Electric Type).

[4] **Auxiliary Closing Spring**

One single high grade stainless steel spring provides a wide operation range, ensuring low opening pressure and secured closing.

[5] **Plug Assembly**

The unitized Flexible Super Travel (FST) plug assembly combines a long travel guided valve plug, peripherally supported diaphragm, and replaceable diaphragm and valve seal. The diaphragm fully meets the valve's operating pressure range requirements.

[5.1] Diaphragm Holder

[5.2] Diaphragm

[5.3] Plug

[5.4] Plug Seal

[6] **hYflow 'Y' Valve Body**

Glass Reinforced nylon construction meets rough service conditions with high chemical and cavitation resistance.

End-to-end "look-through" design and full bore seat with unobstructed flow path, free of any in-line ribs, supporting cage, or shafts, enables ultra-high flow capacity with minimal pressure loss.

[7] **End Connections**

Adaptable on-site to a wide range of end connection types and sizes:

[7.1] Flanges: Plastic or metal "Corona" with elongated slots enable meeting diverse flange standards ISO, ANSI and JIS.

[7.2] Flange adaptor external thread

[7.3] Internal threads

[8] **Flange Adapter**

Articulated flange connections isolate the valve from line bending and pressure stresses.

[9] **Valve Legs**

Stabilizing the valve and serve also as mounting brackets.

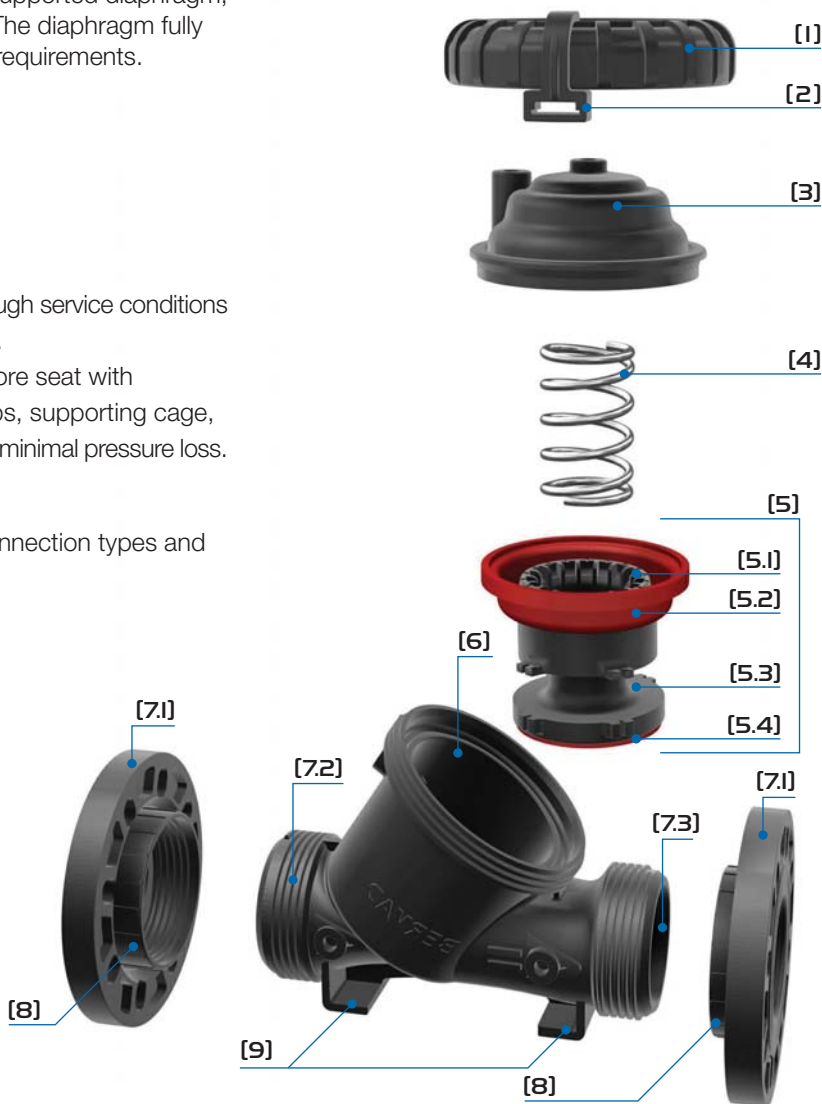

For spare parts ordering, Please use BERMAD "Spare Parts Ordering Guide"

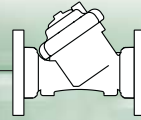

Configuration Options

Additional Valve Configurations



2"; DN50



2 1/2"; DN65 - Male Thread
(for PVC Adapters)



3"; DN80



3"; DN 80 Angle



6"; DN 150 "Y-Boxer" - Flanged



6"; DN 150 "Y-Boxer" - Grooved (Vic)

End Connection Options



BSP.T; NPT Female Thread
2"; DN50



BSP.F Male Thread,
(for PVC Adapters)
2 1/2"; DN65



Union PVC adaptor
2 1/2"; DN65



BSP.T; NPT Female Thread
3"; DN80



Plastic Flange
3"; DN80



Plastic Flange
3"L & 4"; DN: 80L & 100



Metal Flange
3"L & 4"; DN: 80L & 100



PVC Adaptor
3"; DN80



Technical Data



Dimensions & Weights

Size	DN50		DN65	DN 80		DN80L			DN 100		
	Rc 2 (BSP.T)		G 2 1/2 (BSP.F)	Rc 3 (BSP.T)	Universal Flanges		Rc 3 (BSP.T)	Universal Flanges		Universal Flanges	
					Metal	Plastic		Metal	Plastic	Metal	Plastic
L (mm)	230	230	298	308	308	298	310	310	350	350	
H (mm)	185	185	195	255	255	240	280	280	294	290	
h (mm)	40	40	50	100	100	60	100	100	112	112	
W (mm)	135	135	135	200	200	190	200	200	224	224	
CCDV (lit)	0.2	0.2	0.2	0.2	0.2	0.7	0.7	0.7	0.7	0.7	
Weight (kg)	1.35	1.4	1.6	4.4	2.5	3.0	5.9	4.0	7.6	4.9	

CCDV = Control Chamber Displacement Volume

Size	DN80	DN150	
	Angle	Y "Boxer"	
	Rc 3 (BSP.T)	Grooved (Vic)	Universal Flanges*
L (mm)	187	480	480
L1 (mm)	130	N/A	N/A
H (mm)	245	195	285
h (mm)	117	100	145
W (mm)	135	385	385
CCDV (lit)	0.2	2 x 0.7	2 x 0.7
Weight (kg)	1.6	8.8	12.5

CCDV = Control Chamber Displacement Volume

*Reinforced Plastic Flanges

Quick "Horn" Outlet Connection

Size	DN 80	
	Angle	T
	Rc 3 (BSP.T)	Rc 3 (BSP.T)
L (mm)	220	325
L1 (mm)	165	135
H (mm)	245	245
h (mm)	117	117
W (mm)	135	135
CCDV (lit)	0.2	0.2
Weight (kg)	1.7	2.1

Technical Specifications

Available Sizes:

DN: 50, 65, 80, 80L, 100 & 150

Connections Standard:

Threaded: Female BSP-T: DN: 50, 80 & 80L

Male BSP-F: DN65

Flanged: DN: 80, 80L, 100 & 150

Plastic or metal "Corona" with elongated slots enable meeting diverse flange standards

ISO PN10, ANSI 125, JIS 10K

Pressure Rating: 10 bar

Operating Pressure Range: 0.35-10 bar

Temperature: Water up to 60°C

Standard Materials:

- Body, Cover and Plug: Glass Reinforced Nylon
- Diaphragm: NR, Nylon Fabric Reinforced
- Seals: NR
- Spring: Stainless Steel
- Cover bolts (DN: 50, 65 & 80 valves): Stainless Steel

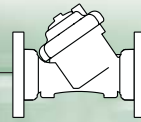

Flow Data



Flow Chart

Y Pattern DN50-150, Angle Pattern DN80

2-Way circuit "Added Head Loss" (for "V" below 2 m/s): 0.3 bar

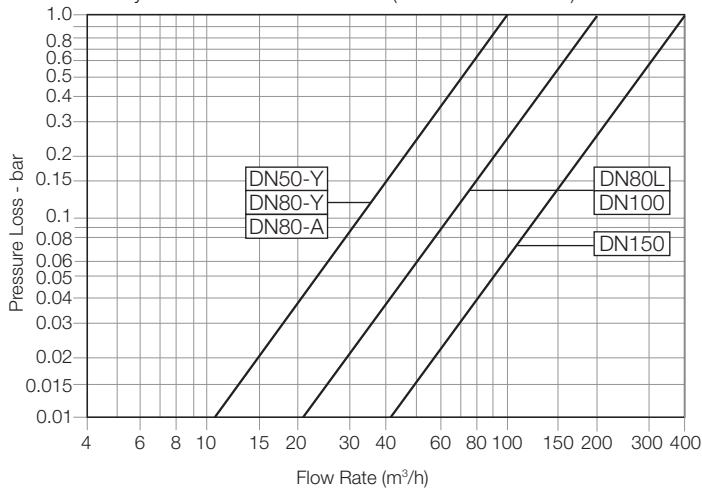

T Pattern DN80

2-Way circuit "Added Head Loss" (for "V" below 2 m/s): 0.3 bar

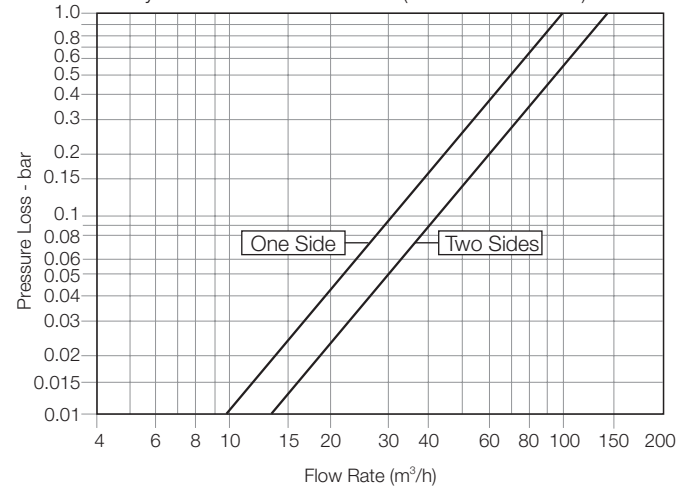

Flow Properties

Y Pattern

Size	DN50	DN65	DN80	DN80L	DN100	DN150
Kv	100	100	100	200	200	400
K	1.0	2.8	6.4	1.6	3.9	5.0
Leq (m)	2.4	9.1	25.7	6.4	19.6	37.2

A Pattern T Pattern DN80

	DN80	One Side	Two Sides
Kv	100	100	140
K	6.4	6.4	3.3
Leq (m)	25.7	25.7	13.1

Valve flow coefficient, Kv or Cv

$$Kv(Cv) = Q \sqrt{\frac{Gf}{\Delta P}}$$

Where:

Kv = Valve flow coefficient (flow in m³/h at 1 bar Diff. Press.)

Cv = Valve flow coefficient (flow in gpm at Diff. Press. 1psi)

Q = Flow rate (m³/h ; gpm)

ΔP = Differential pressure (bar ; psi)

Gf = Liquid specific gravity (Water = 1.0)

$$Kv = 0.865 Cv$$

Flow resistance or Head loss coefficient,

$$K = \Delta H \frac{2g}{V^2}$$

Where:

K = Flow resistance or Head loss coefficient (dimensionless)

ΔH = Head loss (m ; feet)

V = Nominal size flow velocity (m/sec ; feet/sec.)

g = Acceleration of gravity (9.81 m/sec² ; 32.18 feet/sec²)

Equivalent Pipe Length, Leq

$$Leq = Lk \cdot D$$

Where:

Leq = Equivalent nominal pipe length (m ; feet)

Lk = Equivalent length coefficient for turbulent flow in clean commercial steel pipe (SCH 40)

D = Nominal pipe diameter (m ; feet)

Note:

The Leq values given are for general consideration only.



Technical Data



Dimensions & Weights

Size	2"		3"			3"L			4"	
	2" NPT	G 2 1/2" BSP.F	3" NPT	Universal Flanges		3" NPT	Universal Flanges		Universal Flanges	
Connections				Metal	Plastic		Metal	Plastic	Metal	Plastic
L (inch)	9 1/16	9 1/16	11 3/4	12 1/8	12 1/8	11 3/4	12 3/16	12 3/16	13 3/4	13 3/4
H (inch)	7 5/16	7 5/16	7 11/16	10 1/16	10 1/16	9 7/16	11	11	11 9/16	11 7/16
h (inch)	1 9/16	1 9/16	1 15/16	3 15/16	3 15/16	2 3/8	3 15/16	3 15/16	4 7/16	4 7/16
W (inch)	5 5/16	5 5/16	5 5/16	7 7/8	7 7/8	7 1/2	7 7/8	7 7/8	8 13/16	8 13/16
CCDV (gal)	0.05	0.05	0.05	0.05	0.05	0.18	0.18	0.18	0.18	0.18
Weight (lb)	2.97	3.08	3.52	9.68	2.97	6.60	12.98	8.80	16.72	10.78

CCDV = Control Chamber Displacement Volume

Quick "Horn" Outlet Connection

Size	3"		6"	
	Angle		Y "Boxer"	
End Connections	3" NPT		Grooved (Vic)	Universal Flanges*
L (inch)	7 3/8		18 7/8	18 7/8
L1 (inch)	5 1/8		N/A	N/A
H (inch)	9 5/8		7 11/16	11 1/4
h (inch)	4 5/8		3 15/16	5 11/16
W (inch)	5 3/8		15 3/16	15 3/16
CCDV (gal)	0.05		0.18	0.18
Weight (lb)	3.52		17.71	27.50

CCDV = Control Chamber Displacement Volume

*Reinforced Plastic Flanges

Size	3"	
	Angle	T
Inlet Connection	3" NPT	3" NPT
L (inch)	8 11/16	12 13/16
L1 (inch)	6 1/2	6 1/2
H (inch)	9 5/8	9 5/8
h (inch)	4 5/8	4 5/8
W (inch)	5 5/16	5 5/16
CCDV (gal)	0.05	0.05
Weight (lb)	3.37	4.62

Technical Specifications

Available Sizes:

2", 2 1/2", 3", 3"L, 4" & 6"

Connections Standard:

Threaded: Female NPT: 2", 3" & 3"L

Male BSP-F: 2 1/2"

Flanged: 3", 3"L, 4" & 6"

Plastic or metal "Corona" with elongated slots enable meeting diverse flange standards ISO PN10, ANSI 125, JIS 10K

Pressure Rating: 145 psi

Operating Pressure Range: 5-145 psi

Temperature: Water up to 140°F

Standard Materials:

- Body, Cover and Plug: Glass Reinforced Nylon
- Diaphragm: NRJ, Nylon Fabric Reinforced
- Seals: NR
- Spring: Stainless Steel
- Cover bolts (2", 2 1/2" & 3" valves): Stainless Steel



Flow Data

US English

Flow Chart

Y Pattern 2-6", Angle Pattern 3"

2-Way circuit "Added Head Loss" (for "V" below 6.5 f/s): 4.5 psi

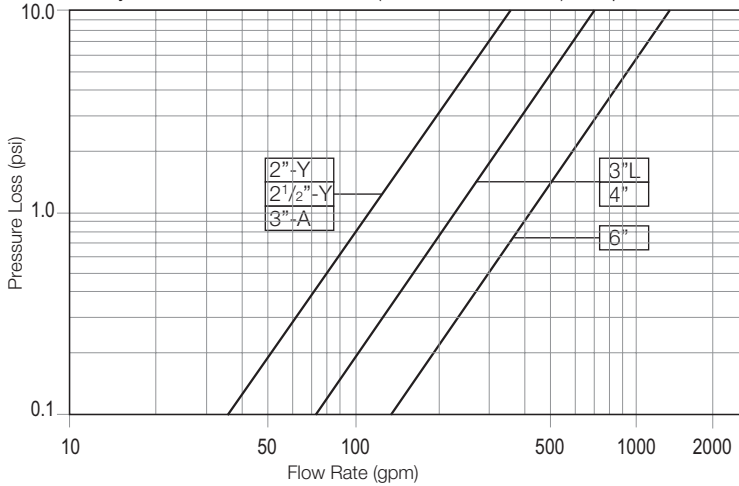

T Pattern 3"

2-Way circuit "Added Head Loss" (for "V" below 6.5 f/s): 4.5 psi

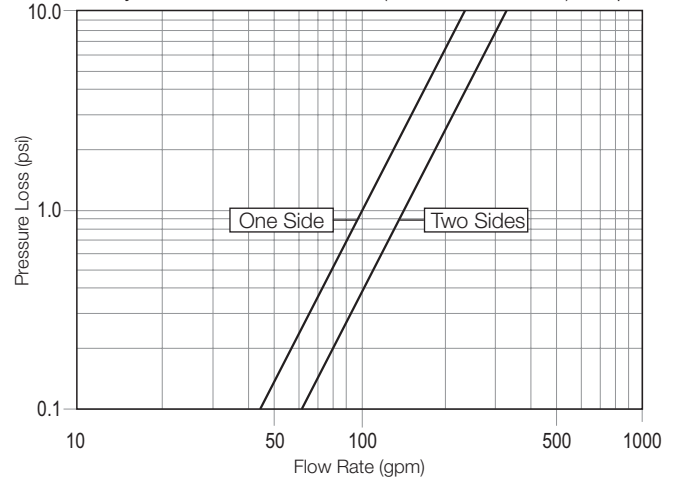

Flow Properties

Y Pattern

Size	2"	2 1/2"	3"	3"L	4"	6"
Cv	115	115	115	230	230	460
K	1.0	2.8	6.4	1.6	3.9	5.0
Leq (ft)	8.0	29.8	84.2	21.1	64.3	122.0

A Pattern T Pattern 3"

3"	One Side	Two Sides
Cv	115	160
K	6.4	3.3
Leq (ft)	84.2	43.0

Valve flow coefficient, Cv or Kv

$$Cv(Kv) = Q \sqrt{\frac{Gf}{\Delta P}}$$

Where:

Kv = Valve flow coefficient (flow in m³/h at 1bar Diff. Press.)

Cv = Valve flow coefficient (flow in gpm at Diff. Press. 1psi)

Q = Flow rate (gpm ; m³/h)

ΔP = Differential pressure (psi ; bar)

Gf = Liquid specific gravity (Water = 1.0)

$$Cv = 1.155 Kv$$

Flow resistance or Head loss coefficient,

$$K = \Delta H \frac{2g}{V^2}$$

Where:

K = Flow resistance or Head loss coefficient (dimensionless)

ΔH = Head loss (feet ; m)

V = Nominal size flow velocity (feet/sec ; m/sec.)

g = Acceleration of gravity (32.18 feet/sec² ; 9.81 m/sec²)

Equivalent Pipe Length, Leq

$$Leq = Lk \cdot D$$

Where:

Leq = Equivalent nominal pipe length (feet ; m)

Lk = Equivalent length coefficient for turbulent flow in clean commercial steel pipe (SCH 40)

D = Nominal pipe diameter (feet ; m)

Note:

The Leq values given are for general consideration only.

Irrigation for Agriculture

Engineering Data

IR-900-M Series

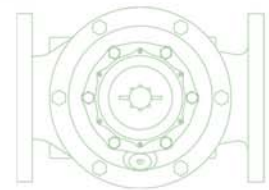
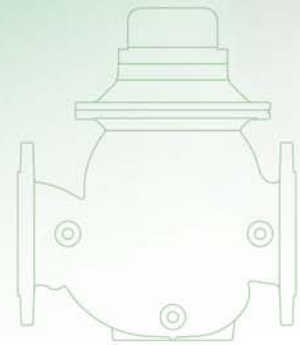
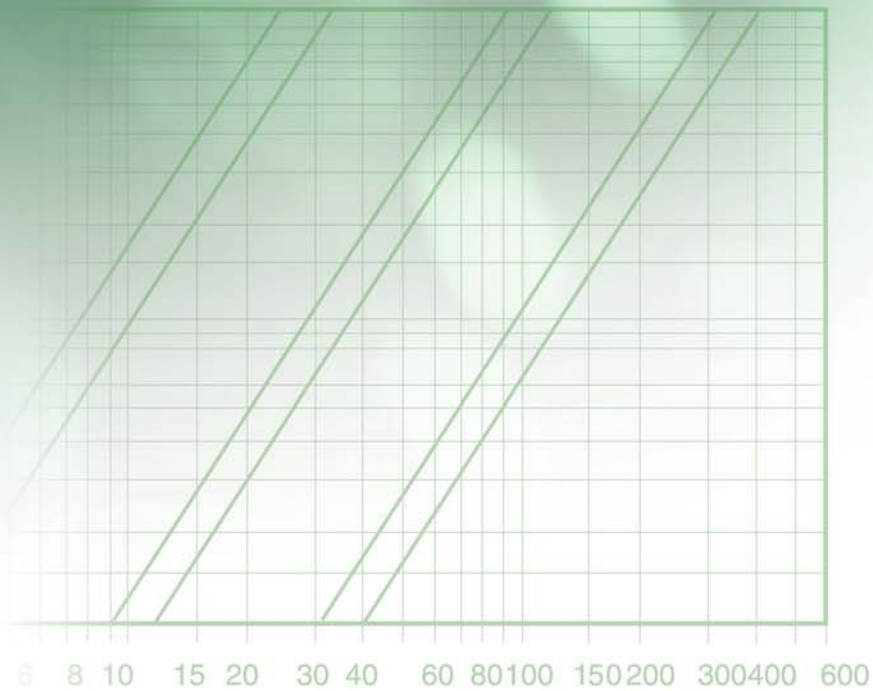

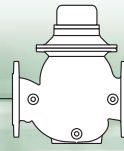

Product Parts Features

[1] Control Head

Includes: Vacuum-sealed meter register, magnetically coupled to the impeller drive. Hermetically sealed control head and its register(s). High sensitivity, providing superior accuracy that exceeds all water meter standards. Range of Reed Switch and Opto-Electric 4-20 mA transmitter options provide greater flexibility in electrical pulse generation.

[2] Valve Cover

Locates, centralizes and fastens diaphragm, spring, and impeller assembly ensuring smooth and accurate performance. Simple and light construction enables quick in-line inspection and service.

[3] Auxiliary Closing Spring

One single spring fully meets valve requirements for operating pressure range, ensuring low opening pressure and secured closing.

[4] Closure Assembly

Combining a rugged radial disk harnessed to a flexible fiber reinforced diaphragm. The fully guided closure assembly and the carefully balanced and peripherally supported diaphragm prevent distortion and protect the elastomer, resulting in long-life and controlled actuation even under harsh conditions. One diaphragm and spring fully meet the valve's operating pressure range requirements.

[5] Impeller Assembly

- [5.1] Guide – Carries the transmission shaft, guides the closure assembly, and centralizes and tightens all internal parts.
- [5.2] Upper Flow Straightener – Tightens the seal seat in place, straightens outlet flow, and creates mushroom-shaped flow.
- [5.3] Impeller – Woltman-type impeller with tungsten carbide shaft tips and bearings for high, long-term accuracy and negligible wear.

[6] Impeller Housing

- [6.1] Lower Flow Straightener – Straightens inlet flow, eliminating the need for straight upstream pipe required in standard water meters.
- [6.2] Seal Seat – Metal ring vulcanized with elastomeric seal, raised and remote from valve body to prevent cavitation damage.

[7] Integrated Calibration Device

Enables recalibration instead of renovation when the recommended standard accuracy period has elapsed (The Calibration Device is stamped closed with a metal seal).

[8] Wide Body

Hydro-dynamically designed for efficient flow with minimal pressure loss and excellent resistance to cavitation.

- [8.1] End Connections conform to pressure ratings and standards: ISO, ANSI, JIS, BS, and others.

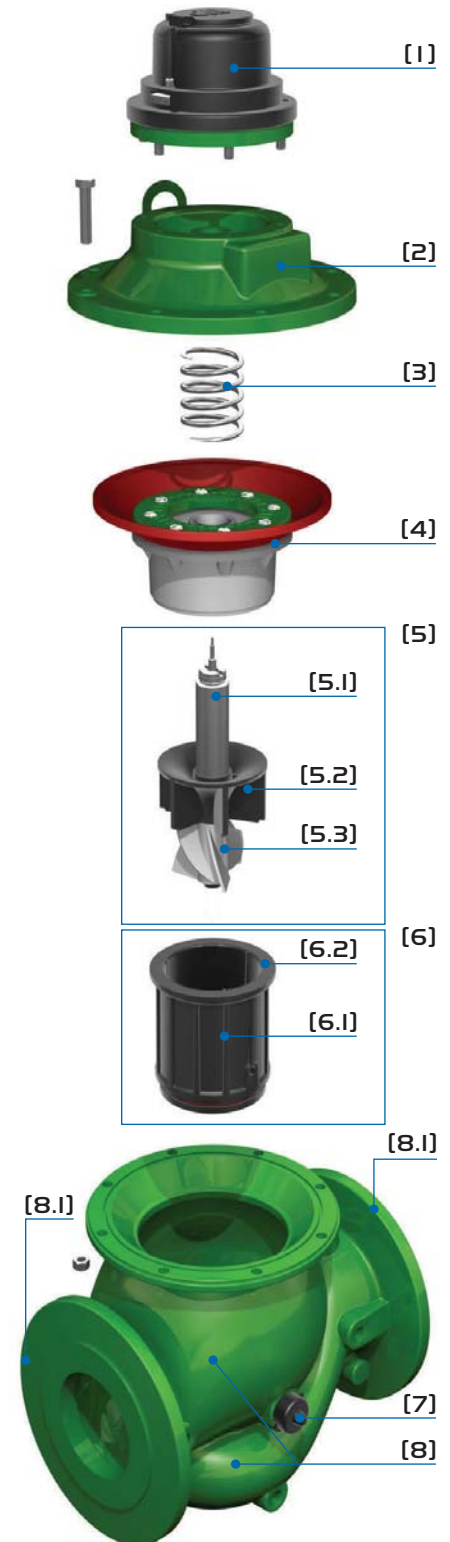

For spare parts ordering, Please use BERMAD “Spare Parts Ordering Guide”

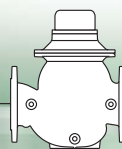

Technical Data



Construction Materials

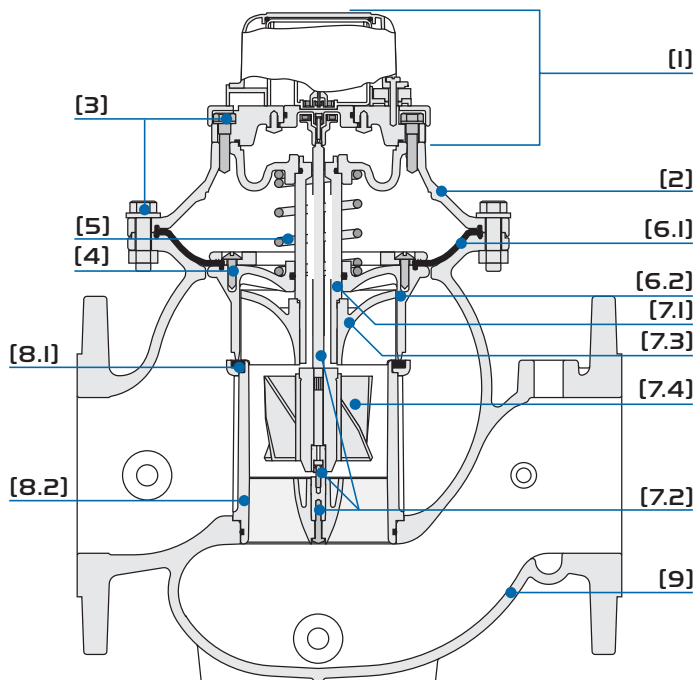

- [1] **Control Head:** Plastic, Stainless Steel and Brass
 - [2] **Cover:** Polyester Coated Ductile Iron to EN 1563
 - [3] **External Bolts / Nuts:** Zinc-Cobalt Plated Steel
 - [4] **Internal Bolts, Nuts and Washers:** Stainless Steel 304 and 316
 - [5] **Spring:** Stainless Steel 302
 - [6] **Closure Assembly:**
 - [6.1] **Diaphragm:** Reinforced Natural Rubber (NR)
 - [6.2] **Closure:** Glass Fiber Reinforced Nylon
 - [7] **Impeller Assembly:**
 - [7.1] **Guide:** Stainless Steel 303
 - [7.2] **Pivots, Bearings, and Thrust Bearings:** Tungsten Carbide
 - [7.3] **Upper Flow Straightener:** Glass Fiber Reinforced Nylon
 - [7.4] **Impeller:** Polypropylene
 - [8] **Impeller Housing Assembly:**
 - [8.1] **Seal Seat:** NBR (Buna-N) Vulcanized Brass
 - [8.2] **Impeller Housing and Lower Flow Straightener:** Glass Fiber Reinforced Nylon
 - [9] **Valve Body:** Polyester Coated Ductile Iron to EN 1563 or Cast Iron
- O-Rings:** NBR (Buna-N)
Coating: Electrostatic Powder Polyester Green RAL 6017, 150 µm

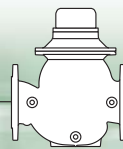

Technical Data



Technical Specifications

Available Patterns, Sizes & End Connections:

Connections	DN40	DN50	DN65	DN80R	DN80	DN100	DN150	DN200	DN250
Threaded	G	G & A		G					
Threaded (Male)	G	G							
Flanged			H*	G	G & A	G, A & H	G & A	G & A	G
Flange Inlet \ Thread Outlet		A	H*	G		H			

G = Globe, A = Angle 90°, H=Hydrant (Angle 120°) * Triangle Flange Inlet

Connections Standard:

Flanged: ISO 7005-2 (PN10 & 16)

Triangle Flange (DN65 inlet only)

Threaded: Rp ISO 7/1 (BSP.P) or NPT

Pressure Rating: PN16

Operating Pressure Ranges:

PN10: 0.7-10 bar

PN16: 0.7-16 bar

For lower pressure requirements, consult factory

Temperature: Water up to 50°C

Pulse Options:

Register Type Pulse Per Size Range	Reed Switch - Single				Reed Switch - Combined	
	10 liter	100 liter	1 m ³	10 m ³	10 liter + 100 liter	100 liter + 1 m ³
DN40-DN100	■	■	■		■	■
DN150-DN250			■	■		

Register Type Pulse Per Size Range	Opto-Electric		Opto-Electric + Reed Switch - Combined			
	1 liter	10 liter	1 liter (Opto) + 100 liter (Reed)	1 liter (Opto) + 1 m ³ (Reed)	10 liter (Opto) + 1 m ³ (Reed)	10 liter (Opto) + 10 m ³ (Reed)
DN40-DN100	■		■	■		
DN150-DN250		■			■	■

Pulse Electric Data:

Reed-Switch: Switching voltage: 48 VAC/DC max

Switching current: 0.2A max

Switching power: 4W max

Opto-Electric: Supply voltage: 5-12 VDC

Output type: complementary

Output current: 200 mA

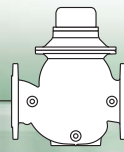

Dimensions & Weights



Globe Pattern

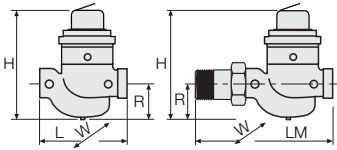

Connection Type	Threaded		
	DN40	DN50	DN80R
L (mm)	250	250	250
LM (mm)	317	327	N/A
W (mm)	137	137	137
H (mm)	270	277	277
R (mm)	95	95	79
Weight (kg)	7.2	7.3	7.3

Globe Pattern

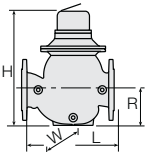

Connection Type	Flanged					
	DN80R	DN80	DN100	DN150	DN200	DN250
L (mm)	310	300	350	500	600	600
W (mm)	200	210	250	380	380	405
H (mm)	298	382	447	602	617	617
R (mm)	100	123	137	216	228	228
Weight (kg)	16.0	23.0	31.0	71.0	93.0	140.5

90° Angle Pattern

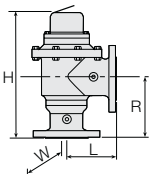

Connection Type	Threaded	Flanged			
	DN50	DN80	DN100	DN150	DN200
L (mm)	120	150	180	250	250
W (mm)	137	210	250	380	380
H (mm)	300	402	481	585	585
R (mm)	125	196	225	306	280
Weight (kg)	8.1	25.8	36.1	76.7	82.5

120° Angle Pattern

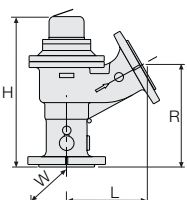

Connection Type	Flanged Inlet / Threaded Outlet		Flanged Inlet and Outlet	
	DN65	DN100	DN65	DN100
L (mm)	143	208	143	208
W (mm)	137	217	200	223
H (mm)	410	450	410	450
R (mm)	273	283	273	283
Weight (kg)	10.5	24.8	12.9	27.9

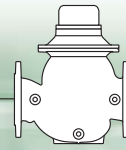

Flow Charts



Globe Pattern

2-Way circuit "Added Head Loss"
(for "V" below 2 m/s): 0.3 bar

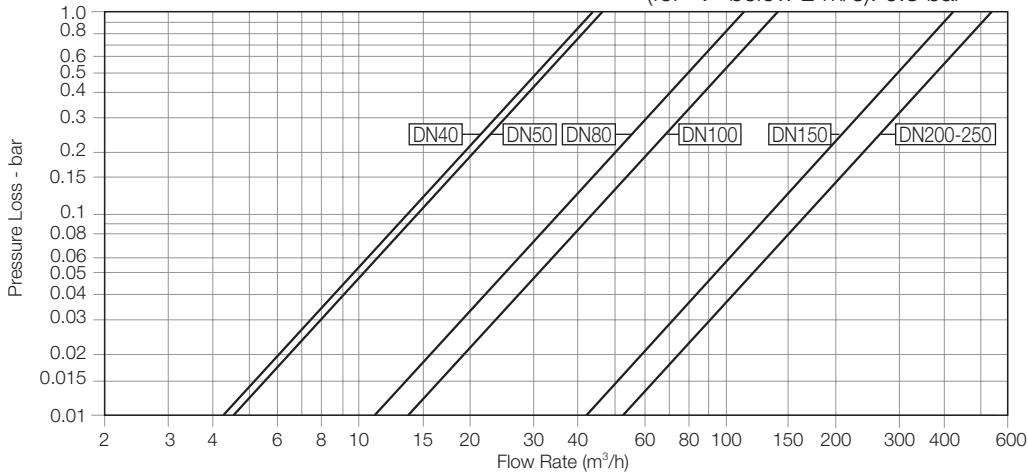

90° Angle Pattern

2-Way circuit "Added Head Loss"
(for "V" below 2 m/s): 0.3 bar

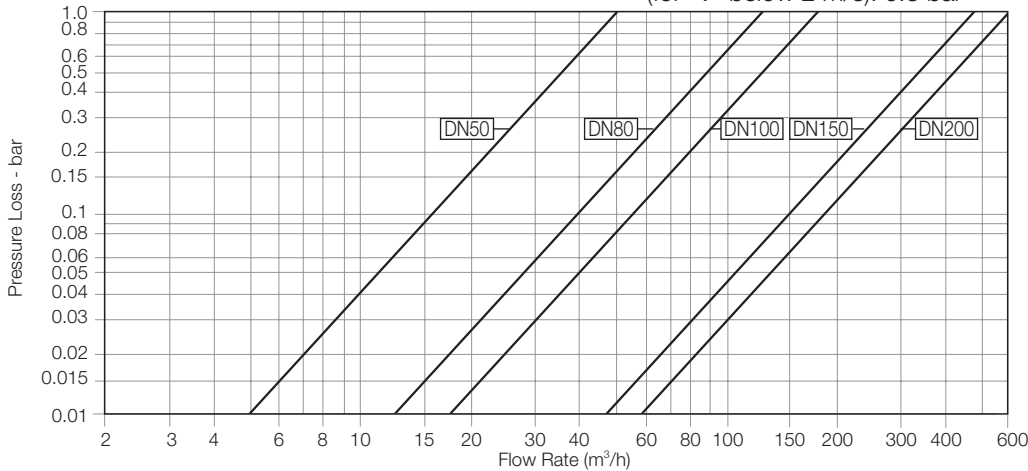

120° Angle Pattern

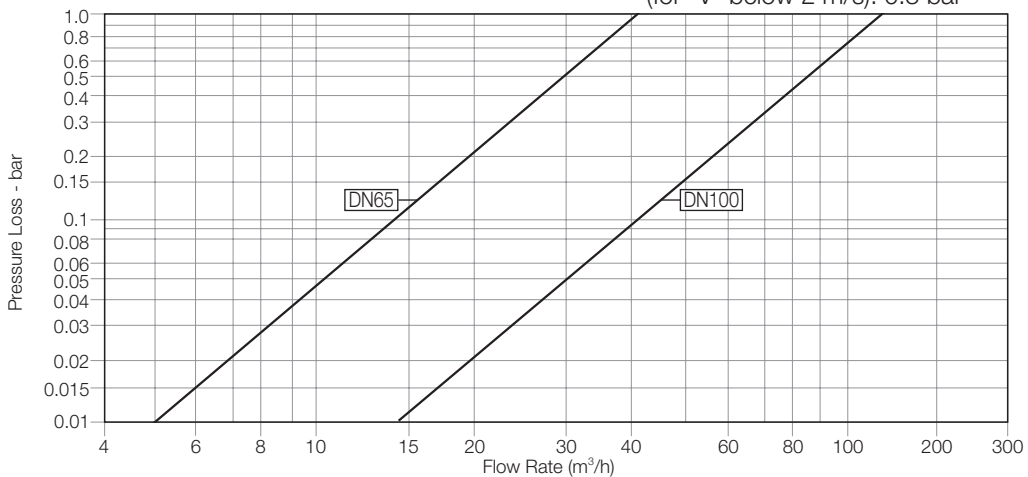

2-Way circuit "Added Head Loss"
(for "V" below 2 m/s): 0.3 bar

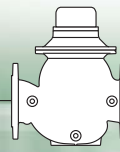



Flow Properties

SI Metric

		Size	DN40	DN50	DN65	DN80R	DN80	DN100	DN150	DN200	DN250
Globe Pattern 	Kv		41	46	N/A	50	115	147	430	550	550
	K		2.4	4.6	N/A	24.7	4.9	7.3	4.3	8.3	20.2
	Leq - m		4.8	12.9	N/A	109.7	21.6	42.7	42.9	110.5	337.2
90°Angle Pattern 	Kv		N/A	51	N/A	N/A	126	180	473	605	N/A
	K		N/A	3.8	N/A	N/A	4.0	4.8	3.5	6.8	N/A
	Leq - m		N/A	10.5	N/A	N/A	18.0	28.4	35.5	91.3	N/A
120°Angle Pattern 	Kv		N/A	N/A	51	N/A	N/A	147	N/A	N/A	N/A
	K		N/A	N/A	3.8	N/A	N/A	7.3	N/A	N/A	N/A
	Leq - m		N/A	N/A	10.5	N/A	N/A	42.7	N/A	N/A	N/A

Valve flow coefficient, Kv or Cv

$$Kv(Cv) = Q \sqrt{\frac{Gf}{\Delta P}}$$

Equivalent Pipe Length, Leq

$$Leq = Lk \cdot D$$

Where:

Kv = Valve flow coefficient (flow in m³/h at 1bar Diff. Press.)

Cv = Valve flow coefficient (flow in gpm at Diff. Press. 1psi)

Q = Flow rate (m³/h ; gpm)

ΔP = Differential pressure (bar ; psi)

Gf = Liquid specific gravity (Water = 1.0)

Where:

Leq = Equivalent nominal pipe length (m ; feet)

Lk = Equivalent length coefficient for turbulent flow in clean commercial steel pipe (SCH 40)

D = Nominal pipe diameter (m ; feet)

Note:

The Leq values given are for general consideration only.

$$Kv = 0.865 Cv$$

Flow resistance or Head loss coefficient,

$$K = \Delta H \frac{2g}{V^2}$$

Where:

K = Flow resistance or Head loss coefficient (dimensionless)

ΔH = Head loss (m ; feet)

V = Nominal size flow velocity (m/sec ; feet/sec.)

g = Acceleration of gravity (9.81 m/sec² ; 32.18 feet/sec²)

Accuracy Table

	Accuracy	DN40	DN50	DN65	DN80	DN100	DN150	DN200	DN250
Q1 Minimum Flow	±5%	0.8	0.8	1.2	1.2	1.8	4	6.3	6.3
Q2 Transitional Flow	±2%	1.3	1.3	1.9	3	4.5	10	15.8	15.8
Qn Nominal Flow ISO 4064-1-1993	±2%	15	15	25	40	60	150	250	400
Q3 Permanent Flow	±2%	25	40	40	100	160	250	400	400
Q4 Maximum Flow (Short Time)	±2%	31	50	50	125	200	313	500	500
Q2/Q1	-	1.6	1.6	1.6	2.5	2.5	2.5	2.5	2.5
Q3/Q1	-	31	50	33	83	89	63	63	63
Class ISO 4064-1-1993	-	A	A	A	B	B	B	B	B

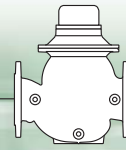

Irrigation Hydrant Valve

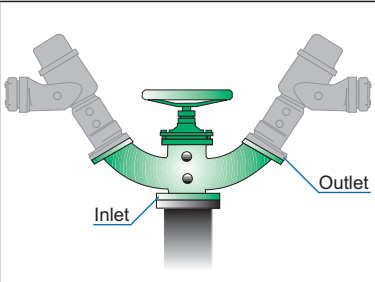
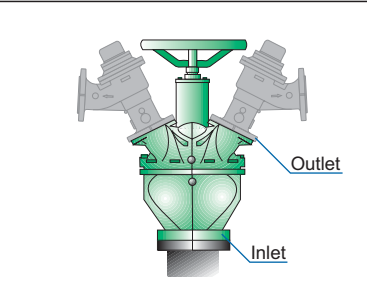
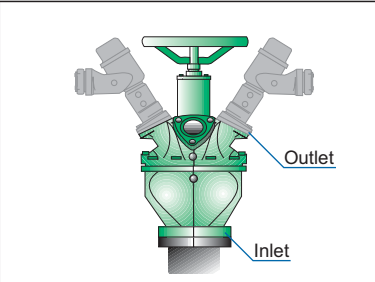

Available Models

			
Description	Type F-82	Type A-102	Type A-104
Inlet Diameter	DN80 (Optional DN100) ⁽¹⁾	DN100 ⁽¹⁾	DN100 ⁽¹⁾
Outlets	2	2	4
Outlet Diameter	DN65 (Triangle)	DN100 ⁽¹⁾	DN65 (Triangle)
Optional Type	F-81 with single outlet	A-152 with DN150 inlet	A-154 with DN150 inlet

(1) Conforming to major standards

Dimensions & Weights

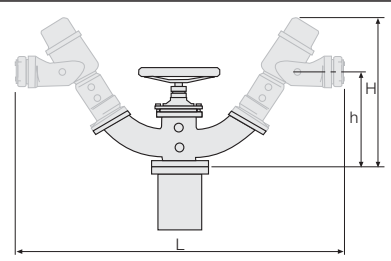
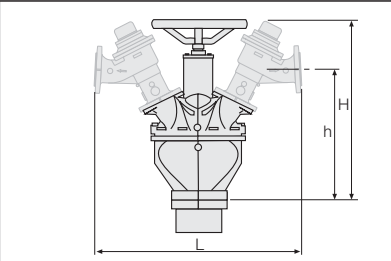
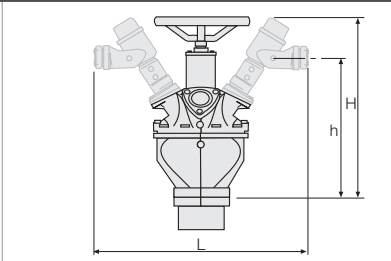
			
Type	F-82	F-102	F-104
L (mm)	1040	1100	970
H (mm)	600	730	700
h (mm)	360	580	510
Weight (kg)	27.0	65.5	51.5
Weight 1*(kg)	36.0	90.5	76.5
Weight 2*(kg)	45.0	115.5	101.5
Weight 3*(kg)	N/A	N/A	126.5
Weight 4*(kg)	N/A	N/A	151.5

* Number of Hydrometers installed.

Flow Charts

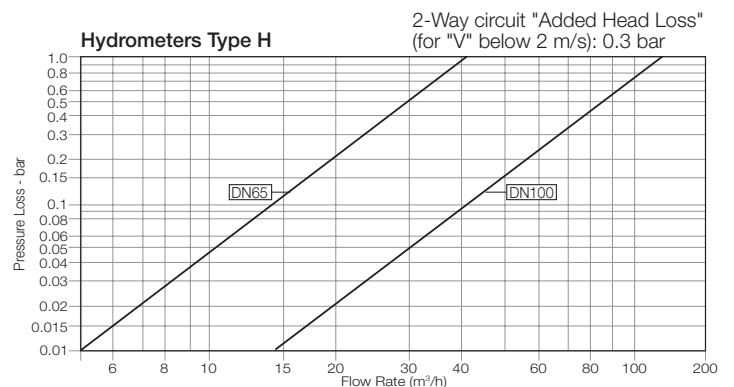
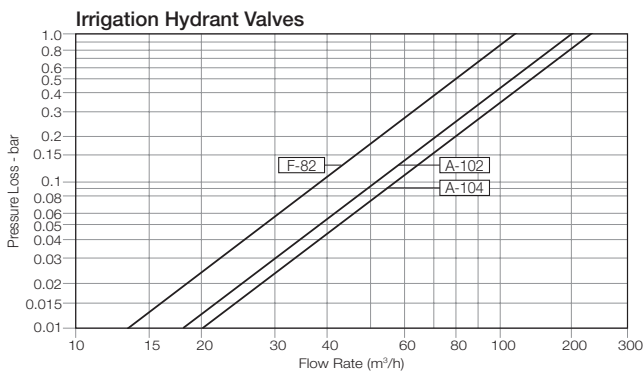

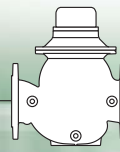

Technical Data



Construction Materials

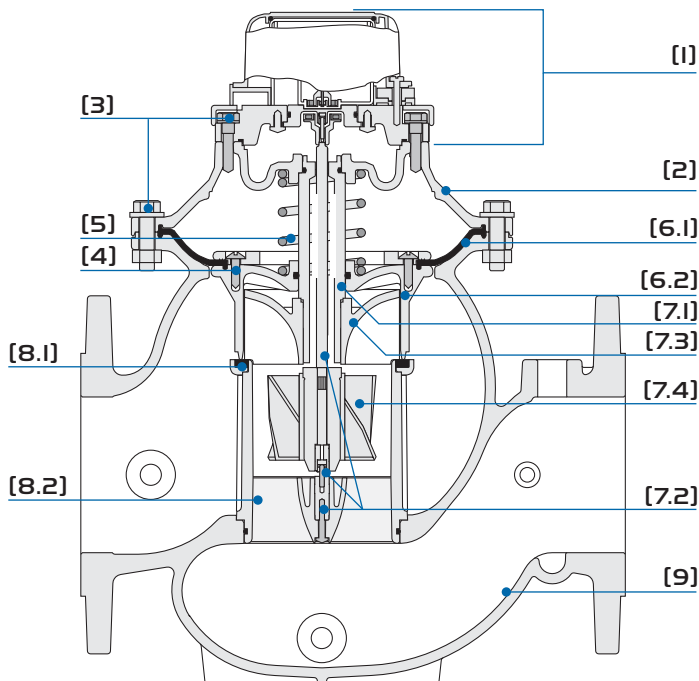

- [1] **Control Head:** Plastic, Stainless Steel and Brass
 - [2] **Cover:** Polyester Coated Ductile Iron to ASTM A536
 - [3] **External Bolts / Nuts:** Zinc-Cobalt Plated Steel
 - [4] **Internal Bolts, Nuts and Washers:** Stainless Steel 304 and 316
 - [5] **Spring:** Stainless Steel 302
 - [6] **Closure Assembly:**
 - [6.1] **Diaphragm:** Reinforced Natural Rubber (NR)
 - [6.2] **Closure:** Glass Fiber Reinforced Nylon
 - [7] **Impeller Assembly:**
 - [7.1] **Guide:** Stainless Steel 303
 - [7.2] **Pivots, Bearings, and Thrust Bearings:** Tungsten Carbide
 - [7.3] **Upper Flow Straightener:** Glass Fiber Reinforced Nylon
 - [7.4] **Impeller:** Polypropylene
 - [8] **Impeller Housing Assembly:**
 - [8.1] **Seal Seat:** NBR (Buna-N) Vulcanized Brass
 - [8.2] **Impeller Housing and Lower Flow Straightener:** Glass Fiber Reinforced Nylon
 - [9] **Valve Body:** Polyester Coated Ductile Iron to ASTM A-536 or Cast Iron to ASTM A-126 Class B
- O-Rings:** NBR (Buna-N)
Coating: Electrostatic Powder Polyester Green RAL 6017, 150 μm

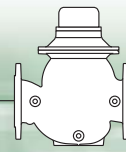

Technical Data



Technical Specifications

Available Patterns, Sizes & End Connections:

Connections	1 1/2"	2"	2 1/2"	3"R	3"	4"	6"	8"	10"
Threaded	G	G & A		G					
Threaded (Male)	G	G							
Flanged			H*	G	G & A	G, A & H	G & A	G & A	G
Flange Inlet \ Thread Outlet		A	H*	G		H			

G = Globe, A = Angle 90°, H= Hydrant (Angle 120°) * Triangle Flange Inlet

Connections Standard:

Flanged: ANSI B16.41 (Cast Iron)
 ANSI B16.42 (Ductile Iron)
 Triangle Flange (2 1/2" inlet only)

Threaded: NPT or Rp ISO 7/1 (BSP.P)

Pressure Rating Classes: Cast Iron - #125; Ductile Iron - #150

Operating Pressure Ranges:

Class #125: 10-150 psi; Class #150: 10-250 psi

For lower pressure requirements, consult factory

Temperature: Water up to 122°F

Pulse Options:

Register Type Pulse Per Size Range	Reed Switch - Single				Reed Switch - Combined	
	1 gallon	10 gallon	100 gallon	1000 gallon	1 gallon + 10 gallon	10 gallon + 100 gallon
1 1/2"-4"	■	■	■		■	■
6"-10"		■	■	■		

Register Type Pulse Per Size Range	Opto-Electric		Opto-Electric + Reed Switch - Combined			
	0.1 gallon	1 gallon	0.1 gallon (Opto) + 1 gallon (Reed)	0.1 gallon (Opto) + 10 gallon (Reed)	1 gallon (Opto) + 100 (Reed)	1 gallon (Opto) + 1000 (Reed)
1 1/2"-4"	■		■	■		
6"-10"		■			■	■

Pulse Electric Data:

Reed-Switch: Switching voltage: 48 VAC/DC max

Switching current: 0.2A max

Switching power: 4W max

Opto-Electric: Supply voltage: 5-12 VDC

Output type: complementary

Output current: 200 mA

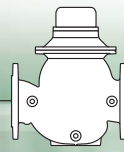

Dimensions & Weights

US English

Globe Pattern

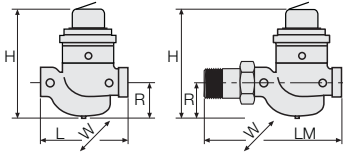

Connection Type	Threaded		
	1 1/2"	2"	3"R
L (inch)	9 ¹³ / ₁₆	9 ¹³ / ₁₆	9 ¹³ / ₁₆
LM (inch)	12 ¹⁷ / ₁₆	12 ¹³ / ₁₆	N/A
W (inch)	5 ³ / ₈	5 ³ / ₈	5 ³ / ₈
H (inch)	10 ⁵ / ₈	10 ¹⁵ / ₁₆	10 ¹⁵ / ₁₆
R (inch)	3.	3 ³ / ₄	3 ¹ / ₈
Weight (lb)	15.9	16.1	16.1

Globe Pattern

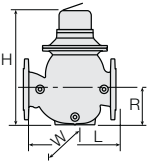

Connection Type	Flanged					
	3"R	3"	4"	6"	8"	10"
L (inch)	12 ³ / ₁₆	11 ¹³ / ₁₆	13 ³ / ₄	19 ¹¹ / ₁₆	23 ⁵ / ₈	23 ⁵ / ₈
W (inch)	7 ⁷ / ₈	8 ¹ / ₄	9 ¹³ / ₁₆	14 ¹⁵ / ₁₆	14 ¹⁵ / ₁₆	15 ¹⁵ / ₁₆
H (inch)	11 ³ / ₄	15 ¹ / ₁₆	17 ⁵ / ₈	23 ¹¹ / ₁₆	24 ⁵ / ₁₆	24 ⁵ / ₁₆
R (inch)	3 ¹⁵ / ₁₆	4 ¹³ / ₁₆	5 ³ / ₈	8 ¹ / ₂	9	9
Weight (lb)	35.3	50.7	66.1	154.3	202.8	309.1

90° Angle Pattern

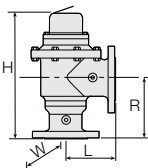

Connection Type	Threaded	Flanged			
	2"	3"	4"	6"	8"
L (inch)	4 ³ / ₄	5 ¹⁵ / ₁₆	7 ¹ / ₁₆	9 ¹³ / ₁₆	9 ¹³ / ₁₆
W (inch)	5 ³ / ₈	8 ¹ / ₄	9 ¹³ / ₁₆	14 ¹⁵ / ₁₆	14 ¹⁵ / ₁₆
H (inch)	11 ¹³ / ₁₆	15 ¹³ / ₁₆	18 ¹⁵ / ₁₆	23	23
R (inch)	4 ¹⁵ / ₁₆	7 ³ / ₄	8 ⁷ / ₈	12 ¹ / ₁₆	11
Weight (lb)	17.4	56.2	78.9	168.4	181.2

120° Angle Pattern

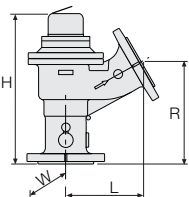

Connection Type	Flanged Inlet / Threaded Outlet		Flanged Inlet and Outlet	
	2 1/2"	4"	2 1/2"	4"
L (inch)	5 ⁵ / ₈	8 ³ / ₁₆	5 ⁵ / ₈	8 ³ / ₁₆
W (inch)	5 ³ / ₈	8 ⁹ / ₁₆	7 ⁷ / ₈	8 ³ / ₄
H (inch)	16 ¹ / ₈	17 ¹¹ / ₁₆	16 ¹ / ₈	17 ¹¹ / ₁₆
R (inch)	10 ³ / ₄	11 ¹ / ₈	10 ³ / ₄	11 ¹ / ₈
Weight (lb)	22.7	54.0	28.0	60.8

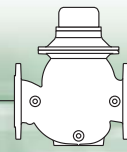

Flow Charts

US English

Globe Pattern

2-Way circuit "Added Head Loss"
(for "V" below 6.5 f/s): 4.5 psi

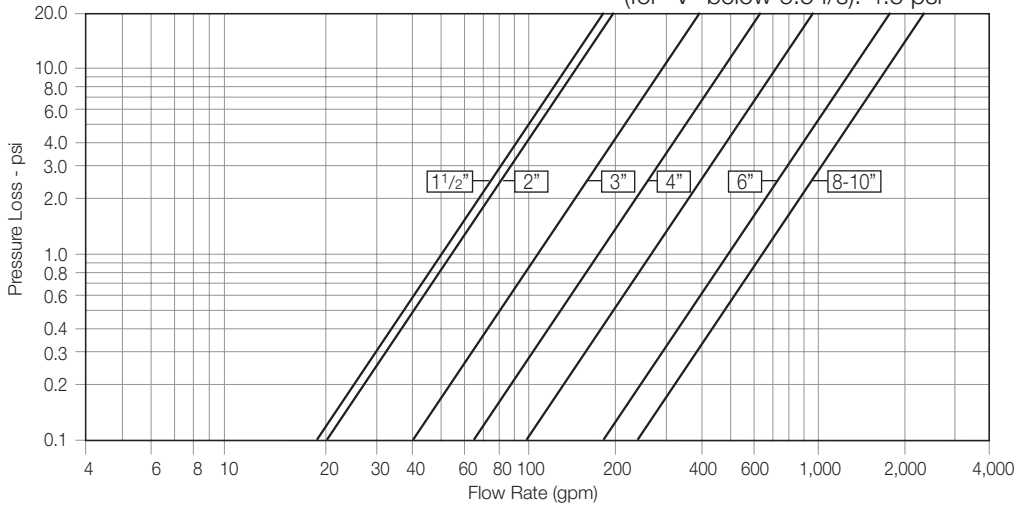

90° Angle Pattern

2-Way circuit "Added Head Loss"
(for "V" below 6.5 f/s): 4.5 psi

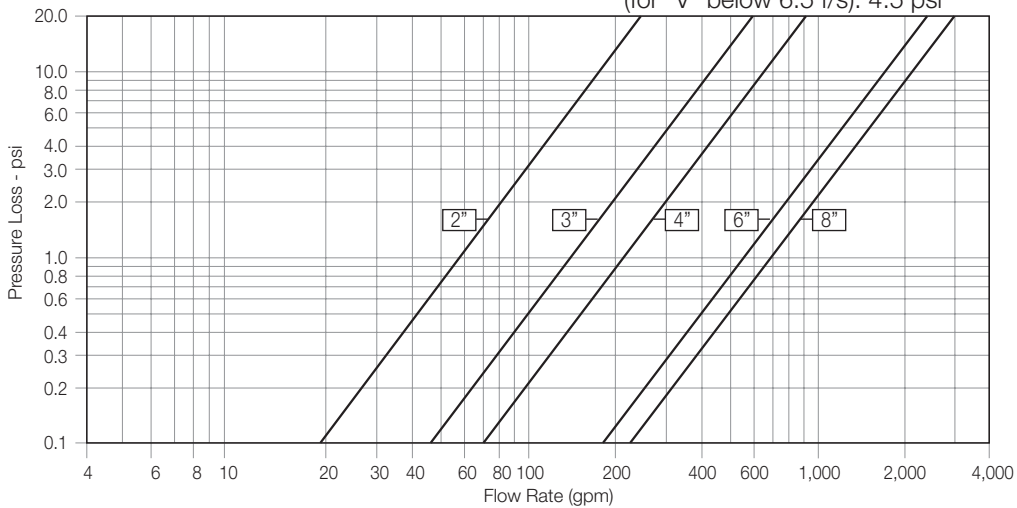

120° Angle Pattern

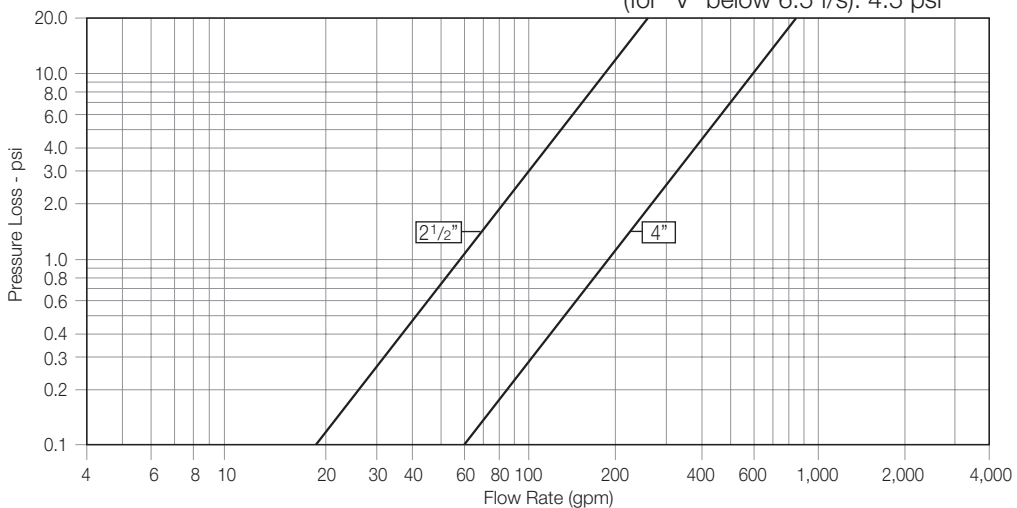

2-Way circuit "Added Head Loss"
(for "V" below 6.5 f/s): 4.5 psi

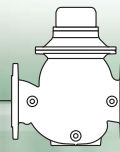



Flow Properties

US English

		Size	1 1/2"	2"	2 1/2"	3"R	3"	4"	6"	8"	10"
Globe Pattern 	Cv	47	53	N/A	58	133	170	497	636	636	
	K	2.4	4.6	N/A	24.7	4.9	7.3	4.3	8.3	20.2	
	Leq - f	15.7	42.2	N/A	359.8	70.8	139.9	140.8	362.5	1106.4	
90° Angle Pattern 	Cv	N/A	59	N/A	N/A	146	208	547	699	N/A	
	K	N/A	3.8	N/A	N/A	4.0	4.8	3.5	6.8	N/A	
	Leq - f	N/A	34.3	N/A	N/A	58.9	93.3	116.3	299.6	N/A	
120° Angle Pattern 	Cv	N/A	N/A	59	N/A	N/A	170	N/A	N/A	N/A	
	K	N/A	N/A	3.8	N/A	N/A	7.3	N/A	N/A	N/A	
	Leq - f	N/A	N/A	34.3	N/A	N/A	139.9	N/A	N/A	N/A	

Valve flow coefficient, Cv or Kv

$$Cv(Kv) = Q \sqrt{\frac{Gf}{\Delta P}}$$

Equivalent Pipe Length, Leq

$$Leq = Lk \cdot D$$

Where:

Kv = Valve flow coefficient (flow in m³/h at 1bar Diff. Press.)

Cv = Valve flow coefficient (flow in gpm at Diff. Press. 1psi)

Q = Flow rate (gpm ; m³/h)

ΔP = Differential pressure (psi ; bar)

Gf = Liquid specific gravity (Water = 1.0)

Where:

Leq = Equivalent nominal pipe length (feet ; m)

Lk = Equivalent length coefficient for turbulent flow in clean commercial steel pipe (SCH 40)

D = Nominal pipe diameter (feet ; m)

$$Cv = 1.155 Kv$$

Note:

The Leq values given are for general consideration only.

Actual Leq may vary somewhat with each of the valve sizes.

Flow resistance or Head loss coefficient,

$$K = \Delta H \frac{2g}{V^2}$$

Where:

K = Flow resistance or Head loss coefficient (dimensionless)

ΔH = Head loss (feet ; m)

V = Nominal size flow velocity (feet/sec ; m/sec.)

g = Acceleration of gravity (32.18 feet/sec² ; 9.81 m/sec²)

Accuracy Table

	Accuracy	1 1/2"	2"	2 1/2"	3"	4"	6"	8"	10"
Q1 Minimum Flow	±5%	3.5	3.5	5.3	5.3	7.9	17.6	27.7	27.7
Q2 Transitional Flow	±2%	5.7	5.7	8.4	13.2	19.8	44	69.6	69.6
Nominal Flow ISO 4064-1-1993	±2%	66	66	110	176	264	660	1100	1761
Q3 Permanent Flow	±2%	110	176	176	440	704	1100	1761	1761
Q4 Flow Maximum (Short Time)	±2%	136	220	220	550	880	1378	2201	2201
Q2/Q1	-	1.6	1.6	1.6	2.5	2.5	2.5	2.5	2.5
Q3/Q1	-	31	50	33	83	89	63	63	63
Class ISO 4064-1-1993	-	A	A	A	B	B	B	B	B

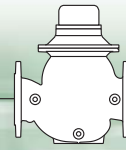

Irrigation Hydrant Valve



Available Models

Description	Type F-82	Type A-102	Type A-104
Inlet Diameter	3" (Optional 4") ⁽¹⁾	4" ⁽¹⁾	4" ⁽¹⁾
Outlets	2	2	4
Outlet Diameter	2 1/2" (Triangle)	4" ⁽¹⁾	2 1/2" (Triangle)
Optional Type	F-81 with single outlet	A-152 with 6" inlet	A-154 with 6" inlet

(1) Conforming to major standards

Dimensions & Weights

Type	F-82	F-102	F-104
L (inch)	40 ^{15/16}	43 ^{5/16}	38 ^{3/16}
H (inch)	23 ^{5/8}	28 ^{3/4}	27 ^{9/16}
h (inch)	14 ^{3/16}	22 ^{13/16}	20 ^{1/16}
Weight (lb)	59.6	144.4	113.6
Weight 1* (lb)	79.4	199.5	168.7
Weight 2* (lb)	99.2	254.6	223.8
Weight 3* (lb)	N/A	N/A	278.9
Weight 4* (lb)	N/A	N/A	334.0

* Number of Hydrometers installed.

Flow Charts

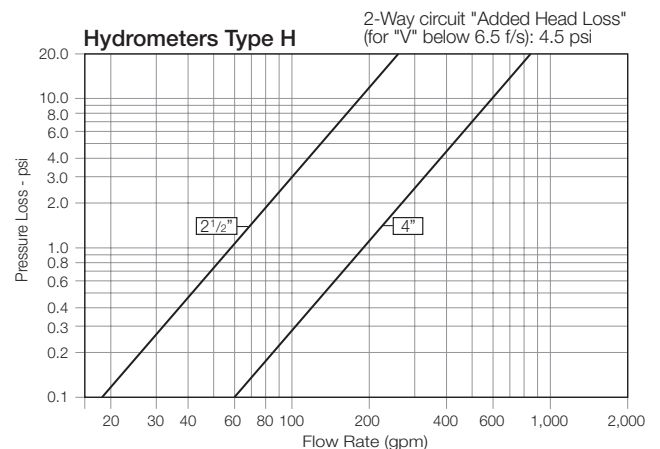
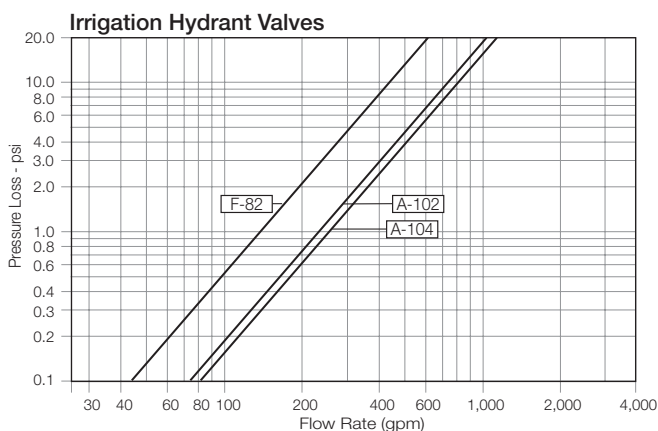

Irrigation for Agriculture

Engineering Data

IR-900-D Series

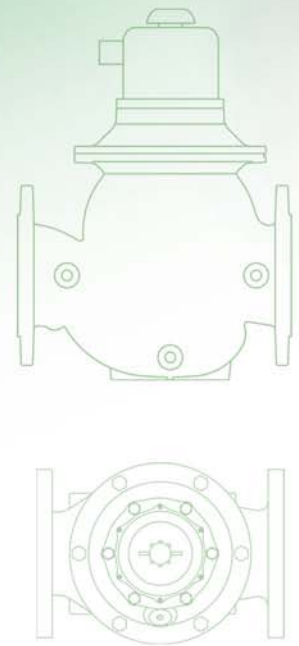
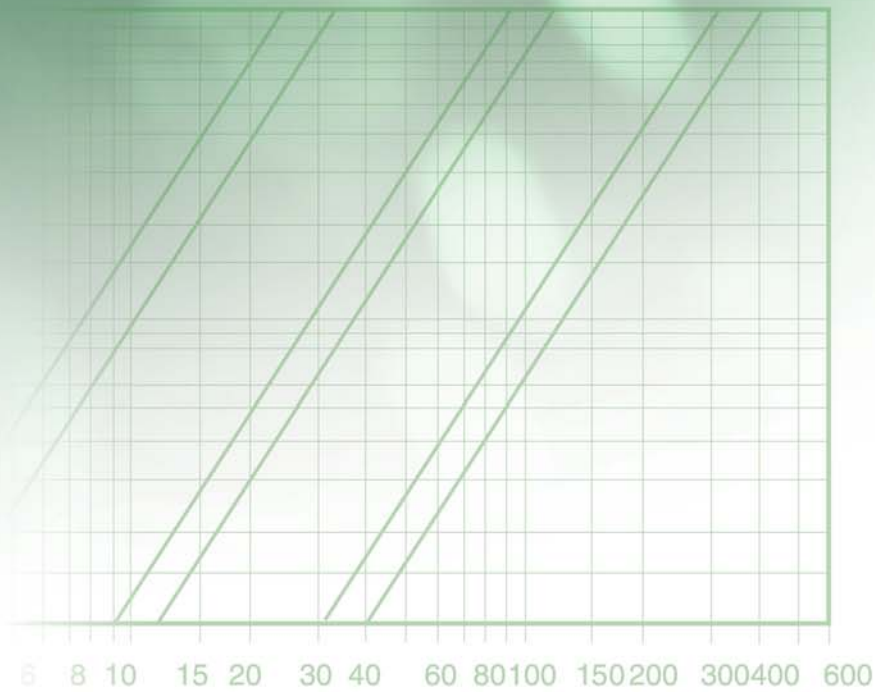

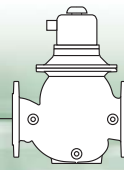

Product Parts Features

[1] Setting Knob

Easy "Push & Set" batch pre-setting

[2] Control Head

Includes: Flow totaling counter, visual flow rate indicator, non-computerized dose control and pulse output for computerized data capture and control.

[2.1] Shut-Off Pilot: Spring loaded pilot which is manually preset to divert line pressure into the AMV control chamber and automatically switches to drain pressure out of the control chamber.

Optional: Sequential Shut-Off Pilot
 Shut-Off Pilot with Pump Shut-Off Electrical Switch.

[3] Valve Cover

Locates, centralizes and fastens diaphragm, spring, and impeller assembly ensuring smooth and accurate performance. Simple and light construction enables quick in-line inspection and service.

[4] Auxiliary Closing Spring

One single spring fully meets valve requirements for operating pressure range, ensuring low opening pressure and secured closing.

[5] Closure Assembly

Combining a rugged radial disk harnessed to a flexible fiber reinforced diaphragm. The fully guided closure assembly and the carefully balanced and peripherally supported diaphragm prevent distortion and protect the elastomer, resulting in long-life and controlled actuation even under harsh conditions. One diaphragm and spring fully meet the valve's operating pressure range requirements.

[6] Impeller Assembly

[6.1] Guide – Carries the transmission shaft, guides the closure assembly, and centralizes and tightens all internal parts.

[6.2] Upper Flow Straightener – Tightens the seal seat in place, straightens outlet flow, and creates mushroom-shaped flow.

[6.3] Impeller – Woltman-type impeller with tungsten carbide shaft tips and bearings for high, long-term accuracy and negligible wear

[7] Impeller Housing

[7.1] Lower Flow Straightener – Straightens inlet flow, eliminating the need for straight upstream pipe required in standard water meters

[7.2] Seal Seat – Metal ring vulcanized with elastomeric seal, raised and remote from valve body to prevent cavitation damage.

[8] Integrated Calibration Device

Enables recalibration instead of renovation when the recommended standard accuracy period has elapsed (The Calibration Device is stamped closed with a metal seal)

[9] Wide Body

Hydro-dynamically designed for efficient flow with minimal pressure loss and excellent resistance to cavitation.

[9.1] End Connections conform to pressure ratings and standards: ISO, ANSI, JIS, BS, and others.

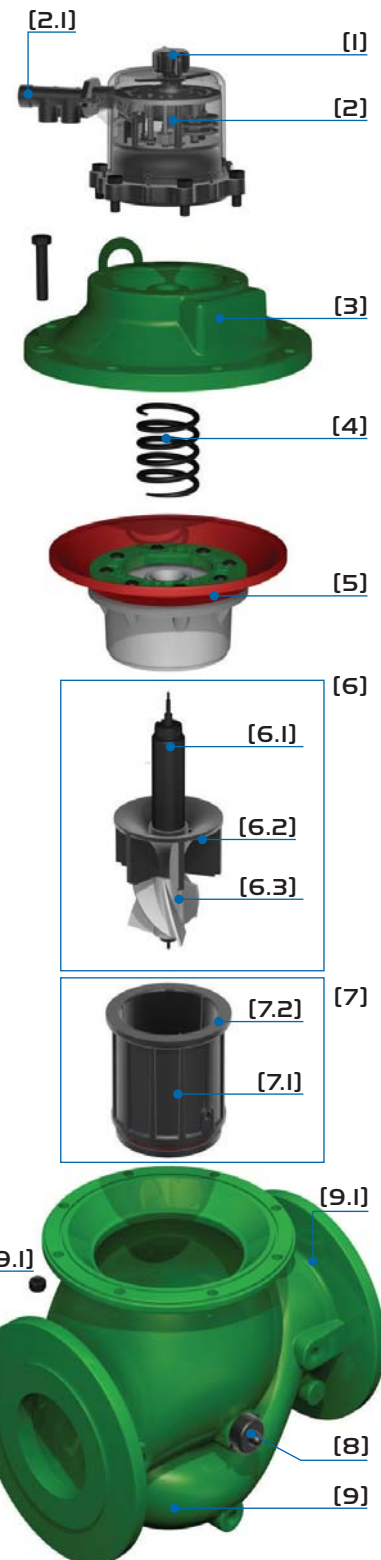

For spare parts ordering, Please use BERMAD "Spare Parts Ordering Guide"

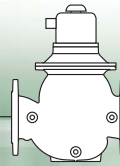

Technical Data



Construction Materials

- [1] Control Head:** Plastic, Stainless Steel and Brass
- [2] Shut-Off Pilot:** Nylon, Stainless Steel & NBR (Buna-N)
- [3] Cover:** Polyester Coated Ductile Iron to EN 1563
- [4] External Bolts / Nuts:** Zinc-Cobalt Plated Steel
- [5] Internal Bolts, Nuts and Washers:** Stainless Steel 304 and 316
- [6] Spring:** Stainless Steel 302
- [7] Closure Assembly:**
 - [7.1] Diaphragm:** Reinforced Natural Rubber (NR)
 - [7.2] Closure:** Glass Fiber Reinforced Nylon
- [8] Impeller Assembly:**
 - [8.1] Guide:** Stainless Steel 303
 - [8.2] Pivots, Bearings, and Thrust Bearings:** Tungsten Carbide
 - [8.3] Upper Flow Straightener:** Glass Fiber Reinforced Nylon
 - [8.4] Impeller:** Polypropylene
- [9] Impeller Housing Assembly:**
 - [9.1] Seal Seat:** NBR (Buna-N) Vulcanized Brass
 - [9.2] Impeller Housing and Lower Flow Straightener:** Glass Fiber Reinforced Nylon
- [10] Valve Body:** Polyester Coated Ductile Iron to EN 1563 or Cast Iron
 - O-Rings:** NBR (Buna-N)
 - Coating:** Electrostatic Powder Polyester Green RAL 6017, 150 µm

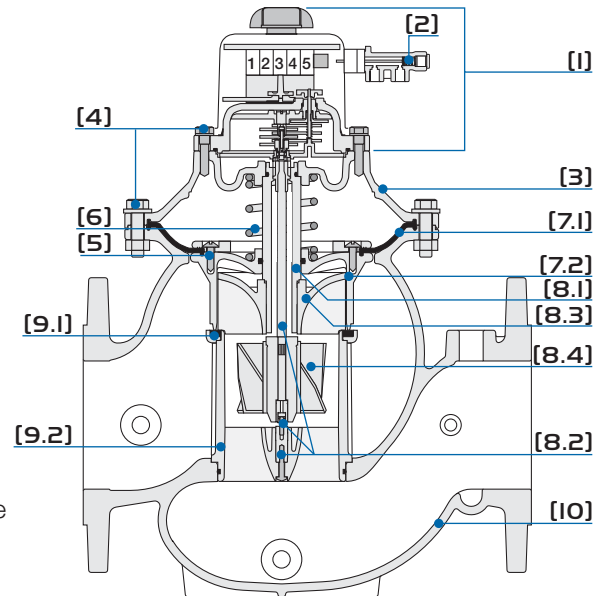

Technical Specifications

Available Patterns, Sizes & End Connections:

Connections	DN40	DN50	DN65	DN80R	DN80	DN100	DN150	DN200	DN250
Threaded	G	G & A		G					
Threaded (Male)	G	G							
Flanged			H*	G	G & A	G, A & H	G & A	G & A	G
Flange Inlet \ Thread Outlet		A	H*	G		H			

G = Globe, A = Angle 90°, H= Hydrant (Angle 120°) * Triangle Flange Inlet

Connections Standard:

Flanged: ISO 7005-2 (PN10 & 16)
 Triangle Flange (DN65 inlet only)
 Threaded: Rp ISO 7/1 (PSP.P) or NPT

Pressure Ratings:

PN10 (Plastic Primary Gear Cover)
 PN16 (Metal Primary Gear Cover)

Operating Pressure Ranges:

PN10: 0.7-10 bar
 PN16: 0.7-16 bar
 For lower pressure requirements, consult factory

Temperature: Water up to 50°C

Dial Options

Dial Capacity (m ³)	3.8	12	40	80	120	150	200	350	600	800	1,200	2,100	3,500	6,000	8,000	12,000	21,000
Graduation (m ³)	0.1	0.2	1	1	2	2	5	10	10	10	20	50	100	100	100	200	500
DN40-DN80	■	■	■	■	■	■	■	■	■	■	■	■					
DN100-DN250				■	■	■	■	■	■	■	■	■	■	■	■	■	■

Pulse Options:

For Dials 3.8 through 2,100: 1 Pulse per 1 m³
 For Dials 3,500 through 21,000: 1 Pulse per 10 m³

Pulse Electrical Data:

Switching Voltage: 48 VAC/DC max.
 Switching Current: 0.2A max.
 Switching Power: 4W max.

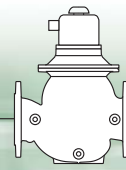

Dimensions & Weights



Globe Pattern

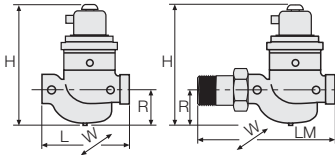

Connection Type	Threaded		
	DN40	DN50	DN80R
L (mm)	250	250	250
LM (mm)	67	77	N/A
W (mm)	137	137	137
H (mm)	293	300	300
R (mm)	95	95	79
Weight (kg)	7.2	7.3	7.3

Globe Pattern

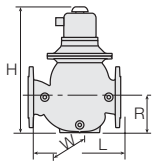

Connection Type	Flanged					
	DN80R	DN80	DN100	DN150	DN200	DN250
L (mm)	310	300	350	500	600	600
W (mm)	200	210	250	380	380	405
H (mm)	321	405	470	625	640	640
R (mm)	100	123	137	216	228	228
Weight (kg)	15.8	23	30	70	92	140

90° Angle Pattern

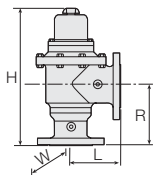

Connection Type	Threaded	Flanged			
	DN50	DN80	DN100	DN150	DN200
L (mm)	120	150	180	250	250
W (mm)	137	210	250	380	380
H (mm)	322	425	500	610	610
R (mm)	125	196	225	306	280
Weight (kg)	7.9	25.5	35.8	76.4	82.2

120° Angle Pattern

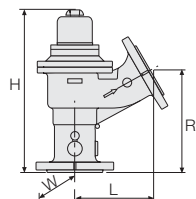

Connection Type	Flanged Inlet / Threaded Outlet		Flanged Inlet and Outlet	
	DN65	DN100	DN65	DN100
L (mm)	143	208	143	208
W (mm)	137	217	200	223
H (mm)	432	472	432	472
R (mm)	273	283	273	283
Weight (kg)	10.3	24.5	12.7	27.6

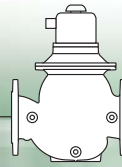

Flow Chart



Globe Pattern

2-Way circuit "Added Head Loss"
(for "V" below 2 m/s): 0.3 bar

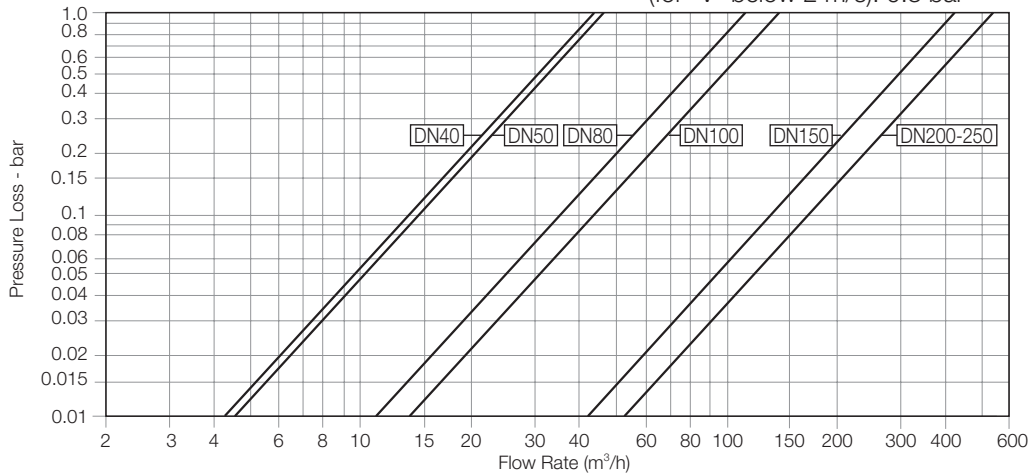

90° Angle Pattern

2-Way circuit "Added Head Loss"
(for "V" below 2 m/s): 0.3 bar

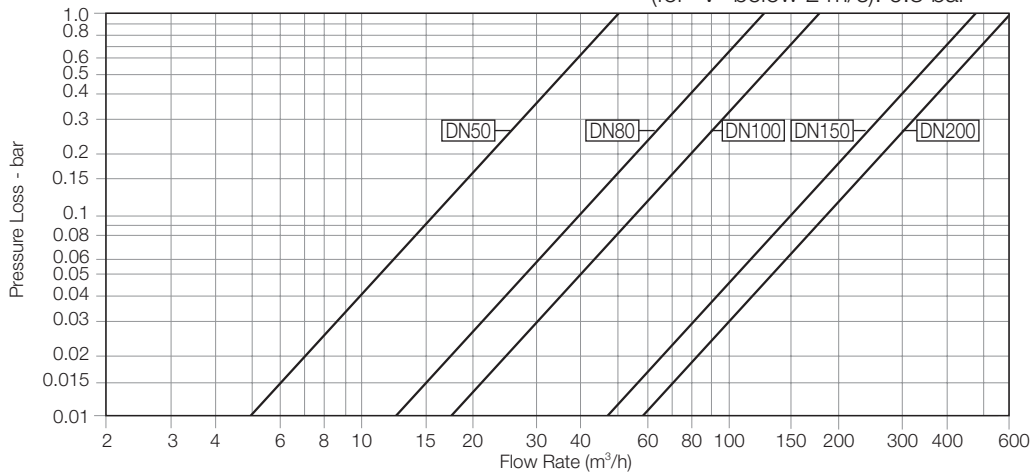

120° Angle Pattern

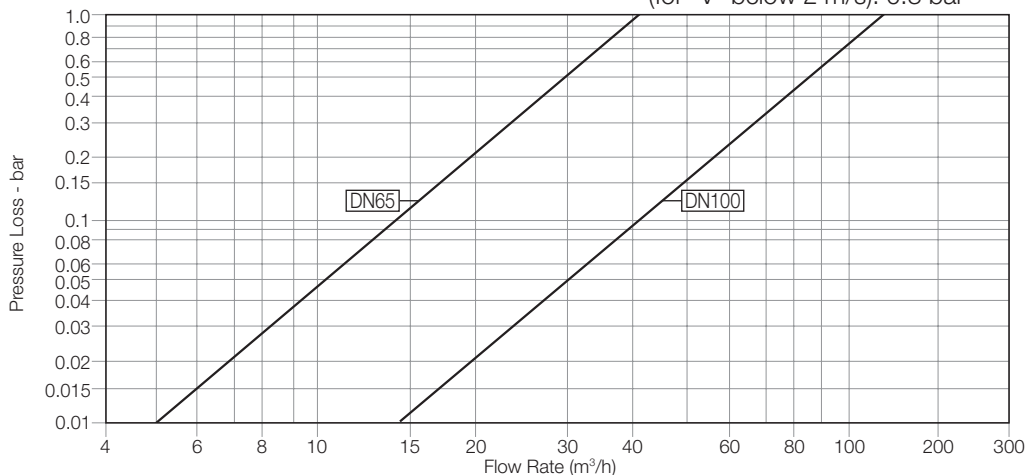

2-Way circuit "Added Head Loss"
(for "V" below 2 m/s): 0.3 bar

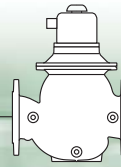



Flow Properties

SI Metric

	Size	DN40	DN50	DN65	DN80R	DN80	DN100	DN150	DN200	DN250
Globe Pattern 	Kv	41	46	N/A	50	115	147	430	550	550
	K	2.4	4.6	N/A	24.7	4.9	7.3	4.3	8.3	20.2
	Leq - m	4.8	12.9	N/A	109.7	21.6	42.7	42.9	110.5	337.2
90° Angle Pattern 	Kv	N/A	51	N/A	N/A	126	180	473	605	N/A
	K	N/A	3.8	N/A	N/A	4.0	4.8	3.5	6.8	N/A
	Leq - m	N/A	10.5	N/A	N/A	18	28.4	35.5	91.3	N/A
120° Angle Pattern 	Kv	N/A	N/A	51	N/A	N/A	147	N/A	N/A	N/A
	K	N/A	N/A	3.8	N/A	N/A	7.3	N/A	N/A	N/A
	Leq - m	N/A	N/A	10.5	N/A	N/A	42.7	N/A	N/A	N/A

Valve flow coefficient, Kv or Cv

$$Kv(Cv) = Q \sqrt{\frac{Gf}{\Delta P}}$$

Equivalent Pipe Length, Leq

$$Leq = Lk \cdot D$$

Where:

Kv = Valve flow coefficient (flow in m³/h at 1bar Diff. Press.)

Cv = Valve flow coefficient (flow in gpm at Diff. Press. 1psi)

Q = Flow rate (m³/h ; gpm)

ΔP = Differential pressure (bar ; psi)

Gf = Liquid specific gravity (Water = 1.0)

$$Kv = 0.865 Cv$$

Where:

Leq = Equivalent nominal pipe length (m ; feet)

Lk = Equivalent length coefficient for turbulent flow in clean commercial steel pipe (SCH 40)

D = Nominal pipe diameter (m ; feet)

Note:

The Leq values given are for general consideration only.

Flow resistance or Head loss coefficient,

$$K = \Delta H \frac{2g}{V^2}$$

Where:

K = Flow resistance or Head loss coefficient (dimensionless)

ΔH = Head loss (m ; feet)

V = Nominal size flow velocity (m/sec ; feet/sec.)

g = Acceleration of gravity (9.81 m/sec² ; 32.18 feet/sec²)

Accuracy Table

	Accuracy	DN40	DN50	DN65	DN80	DN100	DN150	DN200	DN250
Q1 Minimum Flow	±5%	0.8	0.8	1.2	1.2	1.8	4	6.3	6.3
QD Safe Closing (AMV)	±5%	1.5	2	2	3.2	4.8	10	12	12
Q2 Transitional Flow	±2%	1.3	1.3	1.9	3	4.5	10	15.8	15.8
Qn Nominal Flow ISO 4064-1-1993	±2%	15	15	25	40	60	150	250	400
Q3 Permanent Flow	±2%	25	40	40	100	160	250	400	400
Q4 Maximum Flow (Short Time)	±2%	31	50	50	125	200	313	500	500
Q2/Q1	-	1.6	1.6	1.6	2.5	2.5	2.5	2.5	2.5
Q3/Q1	-	31	50	33	83	89	63	63	63
Class ISO 4064-1-1993	-	A	A	A	B	B	B	B	B

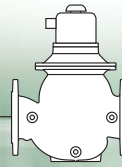

Technical Data



Construction Materials

- [1] Control Head:** Plastic, Stainless Steel and Brass
- [2] Shut-Off Pilot:** Nylon, Stainless Steel & NBR (Buna-N)
- [3] Cover:** Polyester Coated Ductile Iron to ASTM A536
- [4] External Bolts / Nuts:** Zinc-Cobalt Plated Steel
- [5] Internal Bolts, Nuts and Washers:** Stainless Steel 304 and 316
- [6] Spring:** Stainless Steel 302
- [7] Closure Assembly:**
 - [7.1] Diaphragm:** Reinforced Natural Rubber (NR)
 - [7.2] Closure:** Glass Fiber Reinforced Nylon
- [8] Impeller Assembly:**
 - [8.1] Guide:** Stainless Steel 303
 - [8.2] Pivots, Bearings, and Thrust Bearings:** Tungsten Carbide
 - [8.3] Upper Flow Straightener:** Glass Fiber Reinforced Nylon
 - [8.4] Impeller:** Polypropylene
- [9] Impeller Housing Assembly:**
 - [9.1] Seal Seat:** NBR (Buna-N) Vulcanized Brass
 - [9.2] Impeller Housing and Lower Flow Straightener:** Glass Fiber Reinforced Nylon
- [10] Valve Body:** Polyester Coated Ductile Iron to ASTM A-536 or Cast Iron to ASTM A-126 Class B
 - O-Rings:** NBR (Buna-N)
 - Coating:** Electrostatic Powder Polyester Green RAL 6017, 150 µm

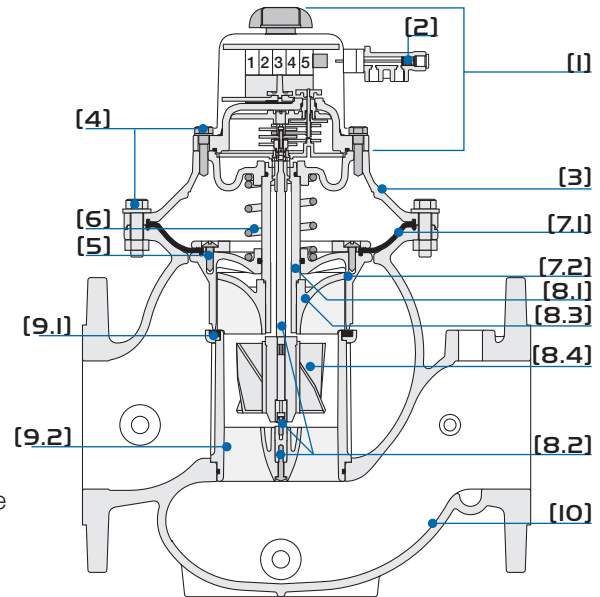

Technical Specifications

Available Patterns, Sizes & End Connections:

Connections\Size	DN40	DN50	DN65	DN80R	DN80	DN100	DN150	DN200	DN250
Threaded	G	G & A		G					
Threaded (Male)	G	G							
Flanged			H*	G	G & A	G, A & H	G & A	G & A	G
Flange Inlet \ Thread Outlet		A	H*	G		H			

G = Globe, A = Angle 90°, H= Hydrant (Angle 120°) * Triangle Flange Inlet

Connections Standard:

Flanged: ANSI B16.41 (Cast Iron)
 ANSI B16.42 (Ductile Iron)
 Triangle Flange (2 1/2" inlet only)
 Threaded: NPT or Rp ISO 7/1 (BSP.P)

Pressure Rating Classes:

150 psi (Plastic Primary Gear Cover)
 Cast Iron - #125; Ductile Iron - #150 (Metal Primary Gear Cover)

Operating Pressure Ranges:

Class #125: 10-150 psi;
 Class #150: 10-250 psi
 For lower pressure requirements, consult factory

Temperature: Water up to 122°F

Dial Options

Dial Capacity (gallon)	13,000	50,000	130,000	210,000	500,000	875,000	1,300,000	2,100,000
Graduation (gallon)	0.1	0.2	1	1	2	2	5	10
1 1/2"-3"	■	■	■	■				
6"-10"		■	■	■	■	■	■	■

Pulse Options:

For Dials 13,000 through 210,000: 1 Pulse per 100 gallon
 For Dials 500,000 through 2,100,000: 1 Pulse per 1000 gallon

Pulse Electrical Data:

Switching Voltage: 48 VAC/DC max.
 Switching Current: 0.2A max.
 Switching Power: 4W max.

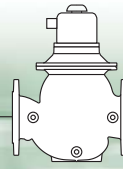

Dimensions & Weights



Globe Pattern

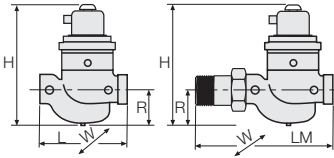

Connection Type	Threaded		
Size	1 1/2"	2"	3"R
L (inch)	9 ¹³ / ₁₆	9 ¹³ / ₁₆	9 ¹³ / ₁₆
LM (inch)	2 ⁵ / ₈	3	N/A
W (inch)	5 ³ / ₈	5 ³ / ₈	5 ³ / ₈
H (inch)	11 ⁹ / ₁₆	11 ¹³ / ₁₆	11 ¹³ / ₁₆
R (inch)	3 ³ / ₄	3 ³ / ₄	3 ¹ / ₈
Weight (kg)	15.9	16.1	16.1

Globe Pattern

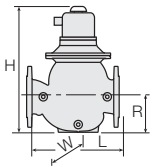

Connection Type	Flanged					
Size	3"R	3"	4"	6"	8"	10"
L (inch)	12 ³ / ₁₆	11 ¹³ / ₁₆	13 ³ / ₄	19 ¹¹ / ₁₆	23 ⁵ / ₈	23 ⁵ / ₈
W (inch)	7 ⁷ / ₈	8 ¹ / ₄	9 ¹³ / ₁₆	14 ¹⁵ / ₁₆	14 ¹⁵ / ₁₆	15 ¹⁵ / ₁₆
H (inch)	12 ⁵ / ₈	15 ¹⁵ / ₁₆	18 ¹ / ₂	24 ⁵ / ₈	25 ³ / ₁₆	25 ³ / ₁₆
R (inch)	3 ¹⁵ / ₁₆	4 ¹³ / ₁₆	5 ³ / ₈	8 ¹ / ₂	9	9
Weight (kg)	35.3	50.7	66.1	154.3	202.8	309.1

90° Angle Pattern

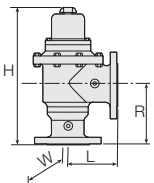

Connection Type	Threaded	Flanged			
Size	2"	3"	4"	6"	8"
L (inch)	4 ³ / ₄	5 ¹⁵ / ₁₆	7 ¹ / ₁₆	9 ¹³ / ₁₆	9 ¹³ / ₁₆
W (inch)	5 ³ / ₈	8 ¹ / ₄	9 ¹³ / ₁₆	14 ¹⁵ / ₁₆	14 ¹⁵ / ₁₆
H (inch)	12 ¹¹ / ₁₆	16 ³ / ₄	19 ¹¹ / ₁₆	24	24
R (inch)	4 ¹⁵ / ₁₆	7 ³ / ₄	8 ⁷ / ₈	12 ¹ / ₁₆	11
Weight (kg)	17.4	56.2	78.9	168.4	181.2

120° Angle Pattern

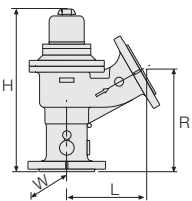

Connection Type	Flanged Inlet / Threaded Outlet		Flanged Inlet and Outlet	
Size	2 1/2"	4"	2 1/2"	4"
L (inch)	5 ⁵ / ₈	8 ³ / ₁₆	5 ⁵ / ₈	8 ³ / ₁₆
W (inch)	5 ³ / ₈	8 ⁹ / ₁₆	7 ⁷ / ₈	8 ³ / ₄
H (inch)	17	18 ⁹ / ₁₆	17	18 ⁹ / ₁₆
R (inch)	10 ³ / ₄	11 ¹ / ₈	10 ³ / ₄	11 ¹ / ₈
Weight (lb)	22.7	54.0	28.0	60.8

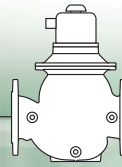

Flow Charts

US English

Globe Pattern

2-Way circuit "Added Head Loss"
(for "V" below 6.5 f/s): 4.5 psi

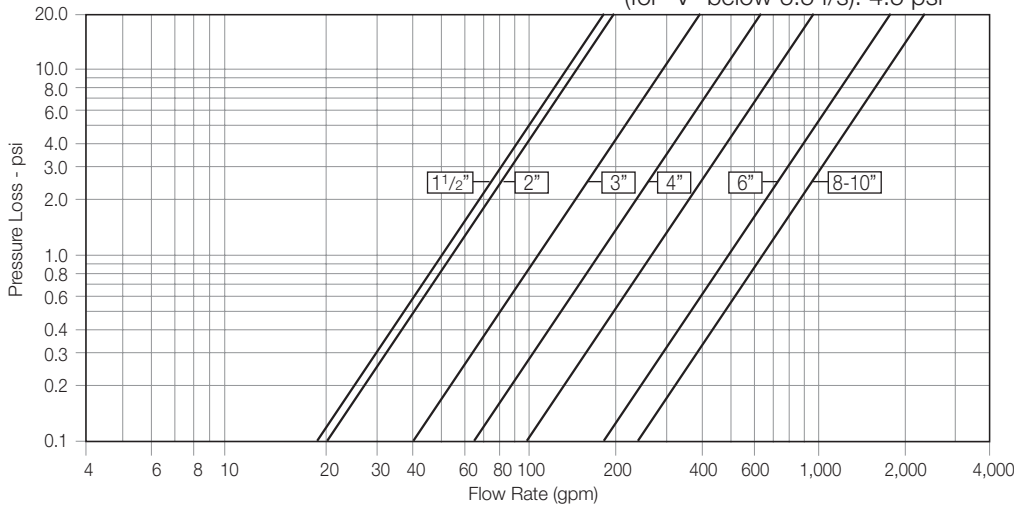

90° Angle Pattern

2-Way circuit "Added Head Loss"
(for "V" below 6.5 f/s): 4.5 psi

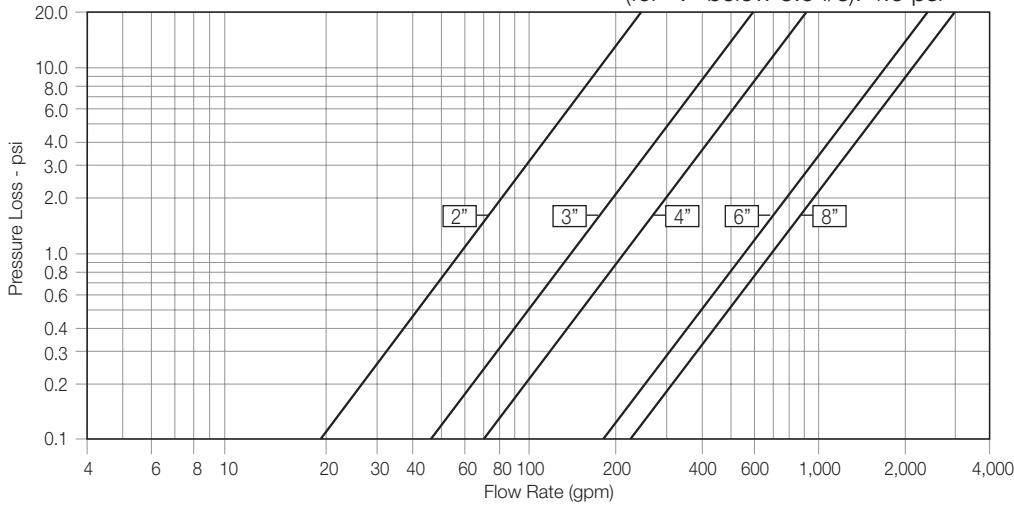

120° Angle Pattern

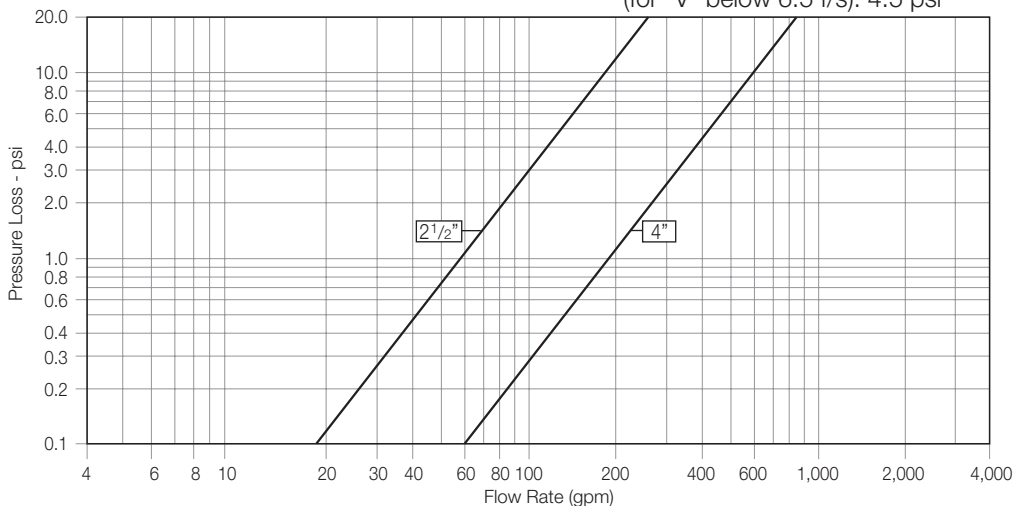

2-Way circuit "Added Head Loss"
(for "V" below 6.5 f/s): 4.5 psi

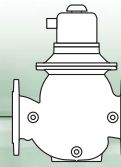



Flow Properties

US English

	Size	1 1/2"	2"	2 1/2"	3"R	3"	4"	6"	8"	10"
Globe Pattern 	Cv	47	53	N/A	58	133	170	497	636	636
	K	2.4	4.6	N/A	24.7	4.9	7.3	4.3	8.3	20.2
	Leq - f	15.7	42.2	N/A	359.8	70.8	139.9	140.8	362.5	1106.4
90° Angle Pattern 	Cv	N/A	59	N/A	N/A	146	208	547	699	N/A
	K	N/A	3.8	N/A	N/A	4.0	4.8	3.5	6.8	N/A
	Leq - f	N/A	34.3	N/A	N/A	58.9	93.3	116.3	299.6	N/A
120° Angle Pattern 	Cv	N/A	N/A	59	N/A	N/A	170	N/A	N/A	N/A
	K	N/A	N/A	3.8	N/A	N/A	7.3	N/A	N/A	N/A
	Leq - f	N/A	N/A	34.3	N/A	N/A	139.9	N/A	N/A	N/A

Valve flow coefficient, Cv or Kv

$$Cv(Kv) = Q \sqrt{\frac{Gf}{\Delta P}}$$

Where:

Kv = Valve flow coefficient (flow in m³/h at 1bar Diff. Press.)

Cv = Valve flow coefficient (flow in gpm at Diff. Press. 1psi)

Q = Flow rate (gpm ; m³/h)

ΔP = Differential pressure (psi ; bar)

Gf = Liquid specific gravity (Water = 1.0)

$$Cv = 1.155 Kv$$

Equivalent Pipe Length, Leq

$$Leq = Lk \cdot D$$

Where:

Leq = Equivalent nominal pipe length (feet ; m)

Lk = Equivalent length coefficient for turbulent flow in clean commercial steel pipe (SCH 40)

D = Nominal pipe diameter (feet ; m)

Note:

The Leq values given are for general consideration only.

Flow resistance or Head loss coefficient,

$$K = \Delta H \frac{2g}{V^2}$$

Where:

K = Flow resistance or Head loss coefficient (dimensionless)

ΔH = Head loss (feet ; m)

V = Nominal size flow velocity (feet/sec ; m/sec.)

g = Acceleration of gravity (32.18 feet/sec² ; 9.81 m/sec²)

Accuracy Table

	Accuracy	1 1/2"	2"	2 1/2"	3"	4"	6"	8"	10"
Q1 Minimum Flow	±5%	3.5	3.5	5.3	5.3	7.9	17.6	27.7	27.7
QD Safe Closing (AMV)	±5%	6.6	8.8	8.8	14.1	21.1	44	52.8	52.8
Q2 Transitional Flow	±2%	5.7	5.7	8.4	13.2	19.8	44	69.6	69.6
Qn Nominal Flow ISO 4064-1-1993	±2%	44	66	110	176	264	660	1100	1761
Q3 Permanent Flow	±2%	110	176	176	440	704	1100	1761	1761
Q4 Maximum Flow (Short Time)	±2%	136	220	220	550	880	1378	2201	2201
Q2/Q1	-	1.6	1.6	1.6	2.5	2.5	2.5	2.5	2.5
Q3/Q1	-	31	50	33	83	89	63	63	63
Class ISO 4064-1-1993	-	A	A	A	B	B	B	B	B

IRIGATION

Irrigation for Agriculture

Engineering Data

WW-700 Series

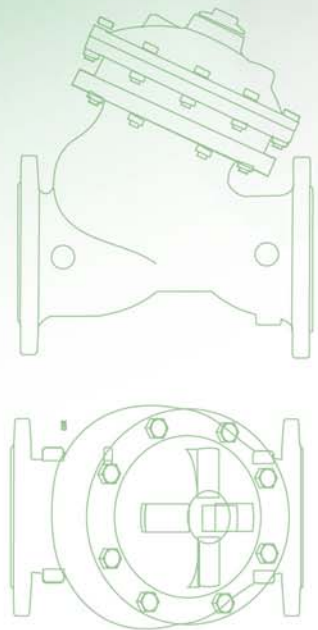
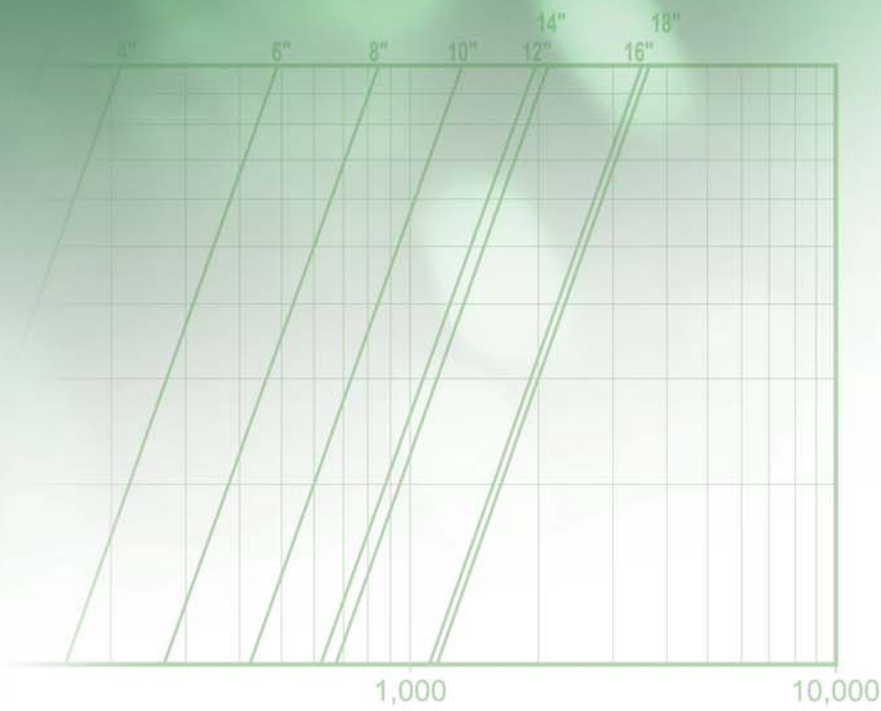

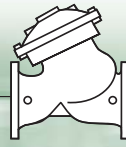

700 Valve - Exploded View

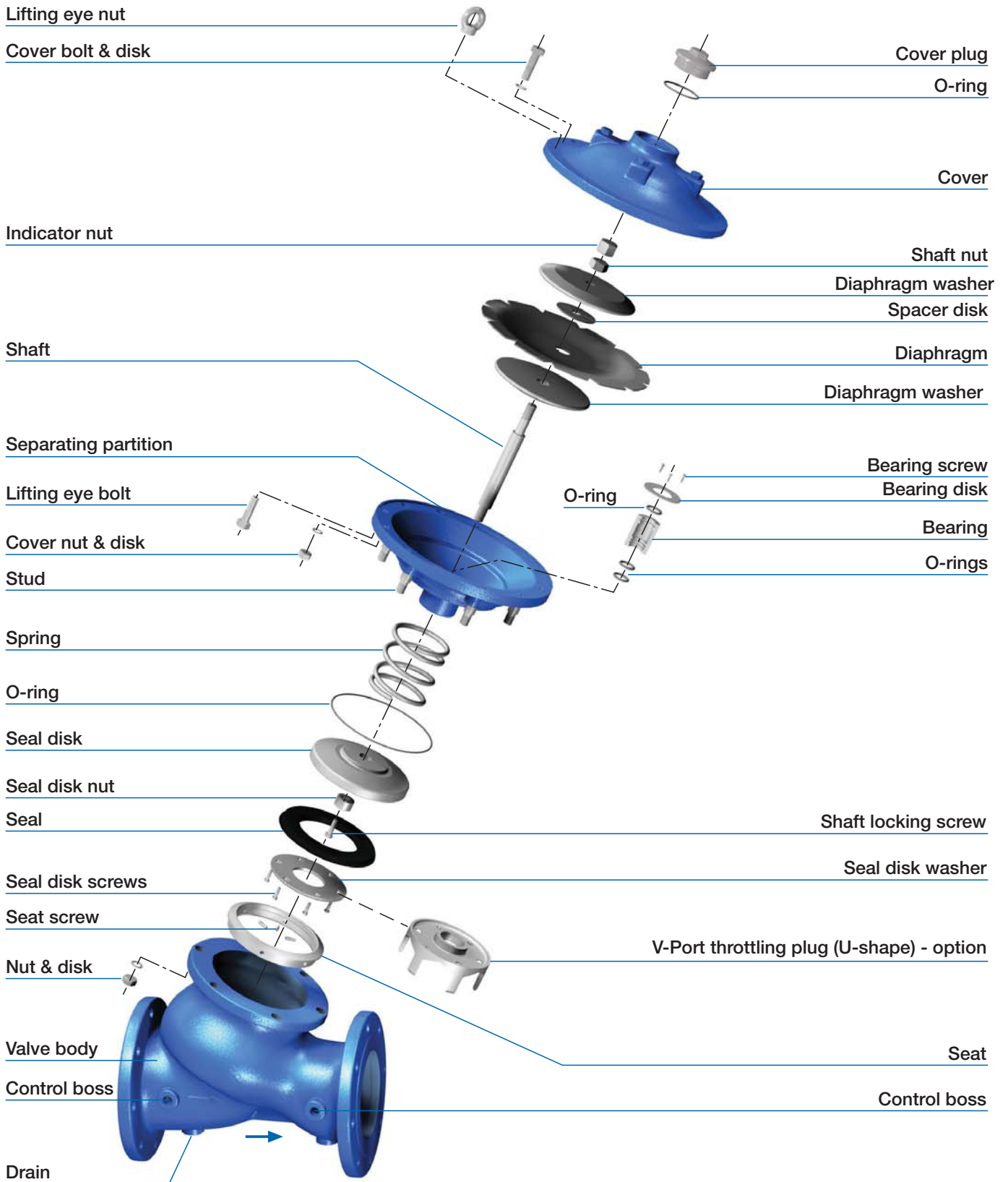

For spare parts ordering, Please use BERMAD "Spare Parts Ordering Guide"

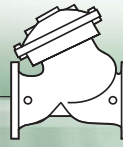

Technical Specifications



SI 700 Metric

Available Sizes & Patterns

- DN 40 - DN 500 - Y Pattern
- DN 40 - DN 450 - Angle
- DN 600 - DN 800 - Globe

Connection Standard

- Flanged: ISO 7005-2 (ISO 10, 16 & 25)
- Threaded: BSP (Rp ISO 7/1) or NPT (DN 40 - DN 80)

Water Temperature

- Up to 80°C

Working pressure

- ISO PN 16: 16 bar
- ISO PN 25: 25 bar

Standard Materials

- **Main valve body and cover**
Ductile Iron to EN 1563
- **Main valve internals**
Stainless Steel, Bronze & Epoxy coated Steel
- **Control Trim**
Brass, Bronze accessories
Stainless Steel 316 fittings & tubing
or forged Brass fittings & Copper tubing
- **Elastomers**
NBR
- **Coating**
Blue fusion bonded Epoxy

Optional Materials

- **Main valve body and cover**
Carbon Steel to EN 10083-1
Stainless Steel 316 to EN 10088-1
Nickel Aluminum Bronze to BS-EN 1400 AB-2
Other materials on request
- **Control Trim**
Stainless Steel 316, Nickel Aluminum Bronze,
Hastalloy C-276 accessories
Monel fittings & tubing
- **Elastomers**
EPDM
FPM



US 700 English

Available Sizes & Patterns

- 1 1/2" - 20" - Y Pattern
- 1 1/2" - 18" - Angle
- 24" - 32" - Globe

Connection Standard

- Flanged: ANSI B16.42 (Ductile Iron)
- Threaded: NPT or BSP (1 1/2" - 3")

Water Temperature

- Up to 180°F

Working pressure

- Class #150: 250 psi
- Class #300: 400 psi

Standard Materials

- **Main valve body and cover**
Ductile Iron to ASTM A-536
- **Main valve internals**
Stainless Steel, Bronze & Epoxy coated Steel
- **Control Trim**
Brass, Bronze accessories
Stainless Steel 316 fittings & tubing
or forged Brass fittings & Copper tubing
- **Elastomers**
NBR
- **Coating**
Blue fusion bonded Epoxy

Optional Materials

- **Main valve body and cover**
Carbon Steel to ASTM A-216-WCB
Stainless Steel 316 to ASTM A-743 CF8M
Nickel Aluminum Bronze to ASTM B-148 C 95800
Other materials on request
- **Control Trim**
Stainless Steel 316, Nickel Aluminum Bronze,
Hastalloy C-276 accessories
Monel fittings & tubing
- **Elastomers**
EPDM
FPM

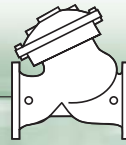

Dimensions & Weights

SI 700 Metric

Flanged

Y Pattern

		mm	40	50	65	80	100	150	200	250	300	350	400	450	500
	ISO PN 10 ; 16	L	205	210	222	250	320	415	500	605	725	733	990	1000	1100
		W	155	165	178	200	223	320	390	480	550	550	740	740	740
		h	78	83	95	100	115	143	172	204	242	268	300	319	358
		H	239	244	257	305	366	492	584	724	840	866	1108	1127	1167
		Weight (Kg)	9.1	10.6	13	22	37	75	125	217	370	381	846	945	962
	ISO PN 20 ; 25	L	205	210	222	264	335	433	524	637	762	767	1024	1030	1136
		W	155	165	185	207	250	320	390	480	550	570	740	740	750
		h	78	83	95	105	127	159	191	223	261	295	325	357	389
		H	239	244	257	314	378	508	602	742	859	893	1133	1165	1197
		Weight (Kg)	10	12.2	15	25	43	85	146	245	410	434	900	967	986

Length according to EN 558-1

		mm	600	700	750	800
	ISO PN 10 ; 16	L	1450	1650	1750	1850
		W	1250	1250	1250	1250
		h	470	490	520	553
		H	1965	1985	2015	2048
		Weight (Kg)	3250	3700	3900	4100
	ISO PN 20 ; 25	L	1500	1650	1750	1850
		W	1250	1250	1250	1250
		h	470	490	520	553
		H	1965	1985	2015	2048
		Weight (Kg)	3500	3700	3900	4100

Y Pattern - Length according to EN 558-1

		DN	50	80	100	150	200	250	300
	ISO PN 10 ; 16	L	230	310	350	480	600	730	850
		W	165	200	235	320	390	480	550
		h	82.5	100	118	150	180	213	243
		H	244	305	369	500	592	733	841
		Weight (Kg)	9.7	21	31	70	115	198	337
	ISO PN 20 ; 25	L	230	310	350	480	600	730	850
		W	165	200	235	320	390	480	550
		h	82.5	100	118	150	180	213	243
		H	244	305	369	500	592	733	841
		Weight (Kg)	9.7	21	31	70	115	198	337

Angle Pattern

		mm	40	50	65	80	100	150	200	250	300	350	400	450
	ISO PN 10 ; 16	L	124	124	149	152	190	225	265	320	396	400	450	450
		W	155	155	178	200	222	320	390	480	550	550	740	740
		R	78	83	95	100	115	143	172	204	248	264	299	320
		h	85	85	109	102	127	152	203	219	273	279	369	370
		H	227	227	251	281	342	441	545	633	777	781	1082	1082
	ISO PN 20 ; 25	L	124	124	149	159	200	234	277	336	415	419	467	467
		W	165	165	185	207	250	320	390	480	550	550	740	740
		R	78	85	95	105	127	159	191	223	261	293	325	358
		h	85	85	109	109	135	165	216	236	294	299	386	386
		H	227	227	251	287	350	454	558	649	796	801	1099	1099
Weight (Kg)	11	11.5	13.5	23	41	81	138	233	390	425	855	870		

Threaded

Angle Pattern

		mm	50	65	80
	BSP ; NPT	L	121	140	159
		W	122	122	163
		R	40	48	55
		h	83	102	115
		H	225	242	294
Weight (Kg)	5.5	7	15		

Y Pattern

		mm	40	50	65	80
	BSP ; NPT	L	155	155	212	250
		W	122	122	122	163
		h	40	40	48	56
		H	201	202	209	264
		Weight (Kg)	5.5	5.5	8	17

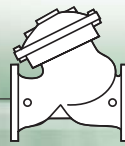

Dimensions & Weights



700 Metric

European Standard (EN 558-1)

Flanged

Y Pattern

		DN	50	80	100	150	200	250	300	350	400	450	500	40	65
	PN 10 ; 16	L*	230	310	350	480	600	730	850	733	990	1000	1100	205	222
		W	165	200	235	320	390	480	550	550	740	740	740	155	190
		h	82.5	100	118	150	180	213	243	268	300	319	358	78	95
		H	244	305	369	500	592	733	841	866	1108	1127	1167	239	257
		Weight (Kg)	9.7	21	31	70	115	198	337	381	846	945	962	9.1	13
	PN 25	L*	230	310	350	480	600	730	850	767	1024	1030	1136	205	222
		W	165	200	235	320	390	480	550	570	740	740	750	155	190
		h	82.5	100	118	150	180	213	243	295	325	357	389	78	95
		H	244	305	369	500	592	733	841	893	1133	1165	1197	239	257
		Weight (Kg)	9.7	21	31	70	115	198	337	434	900	967	986	10	15

* Length according to EN 558-1 for DN 50, 80, 100, 150, 200, 250 & 300.

On request (Y Pattern)

		DN	600	700	750	800	DN	50	80	100	150	200	250	300
	PN 10 ; 16	L*	1450	1650	1750	1850	L	210	250	320	415	500	605	725
		W	1250	1250	1250	1250	W	165	200	229	320	390	480	550
		h	470	490	520	553	h	83	100	115	143	172	204	242
		H	1965	1985	2015	2048	H	244	305	366	492	584	724	840
		Weight (Kg)	3250	3700	3900	4100	Weight (Kg)	10.6	22	37	75	125	217	370
	PN 25	L	1500	1650	1750	1850	L	210	264	335	433	524	637	762
		W	1250	1250	1250	1250	W	165	210	254	320	390	480	550
		h	470	490	520	553	h	83	105	127	159	191	223	261
		H	1965	1985	2015	2048	H	244	314	378	508	602	742	859
		Weight (Kg)	3500	3700	3900	4100	Weight (Kg)	12.2	25	43	85	146	245	410

* Length according to EN 558-1.

Angle Pattern

		DN	40	50	65	80	100	150	200	250	300	350	400	450
	PN 10 ; 16	L	124	124	149	152	190	225	265	320	396	400	450	450
		W	155	155	178	200	222	320	390	480	550	550	740	740
		R	78	83	95	100	115	143	172	204	248	264	299	320
		h	85	85	109	102	127	152	203	219	273	279	369	370
		H	227	227	251	281	342	441	545	633	777	781	1082	1082
	PN 25	L	124	124	149	159	200	234	277	336	415	419	467	467
		W	165	165	185	207	250	320	390	480	550	550	740	740
		R	78	85	95	105	127	159	191	223	261	293	325	358
		h	85	85	109	109	135	165	216	236	294	299	386	386
		H	227	227	251	287	350	454	558	649	796	801	1099	1099
Weight (Kg)	11	11.5	13.5	23	41	81	138	233	390	425	855	870		

Threaded

Angle Pattern

		DN	50	65	80
	BSP ; NPT	L	121	140	159
		W	122	122	163
		R	40	48	55
		h	83	102	115
		H	225	242	294
Weight (Kg)	5.5	7	15		

Y Pattern

		DN	40	50	65	80
	BSP ; NPT	L	155	155	212	250
		W	122	122	122	163
		h	40	40	48	56
		H	201	202	209	264
		Weight (Kg)	5.5	5.5	8	17

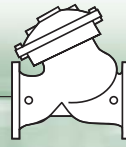

Flow Charts

SI Metric

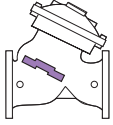

Y Pattern, Flat Disk

2-Way circuit "Added Head Loss" (for "V" below 2 m/s): 0.3 bar

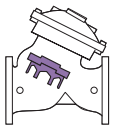
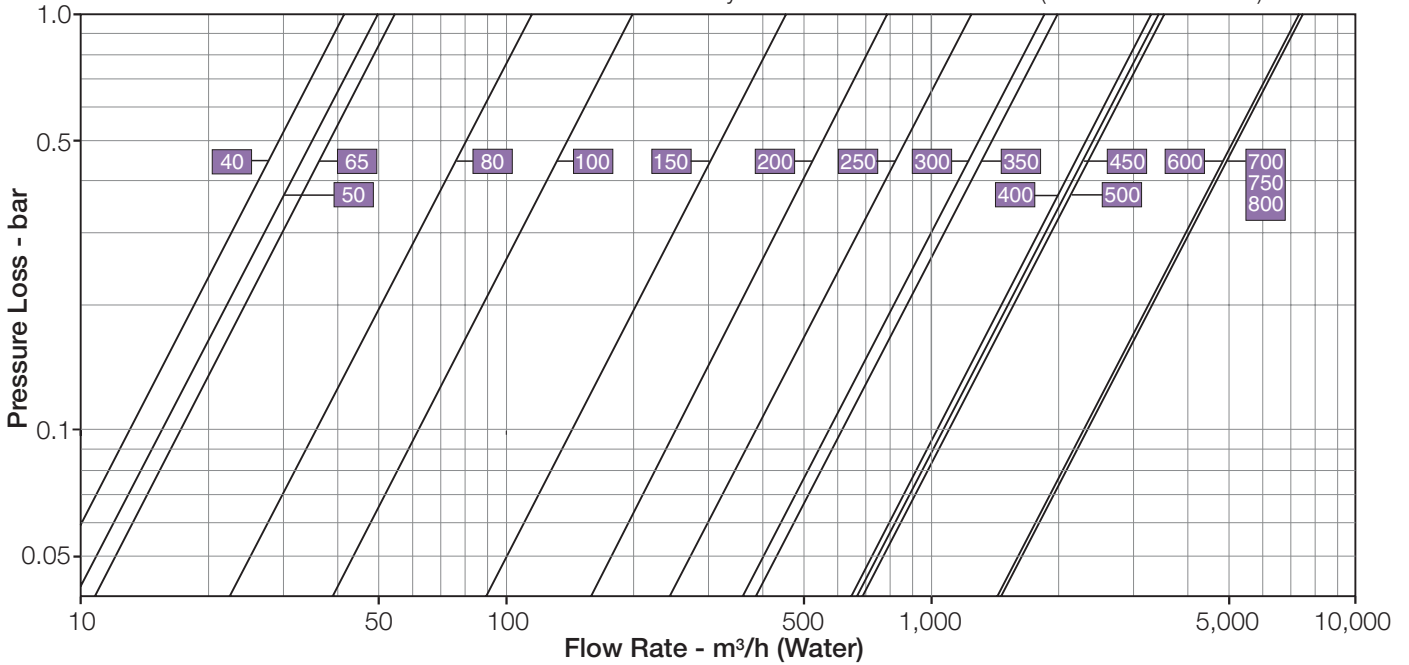

Y Pattern, Throttling Plug (U-Type)

2-Way circuit "Added Head Loss" (for "V" below 2 m/s): 0.3 bar

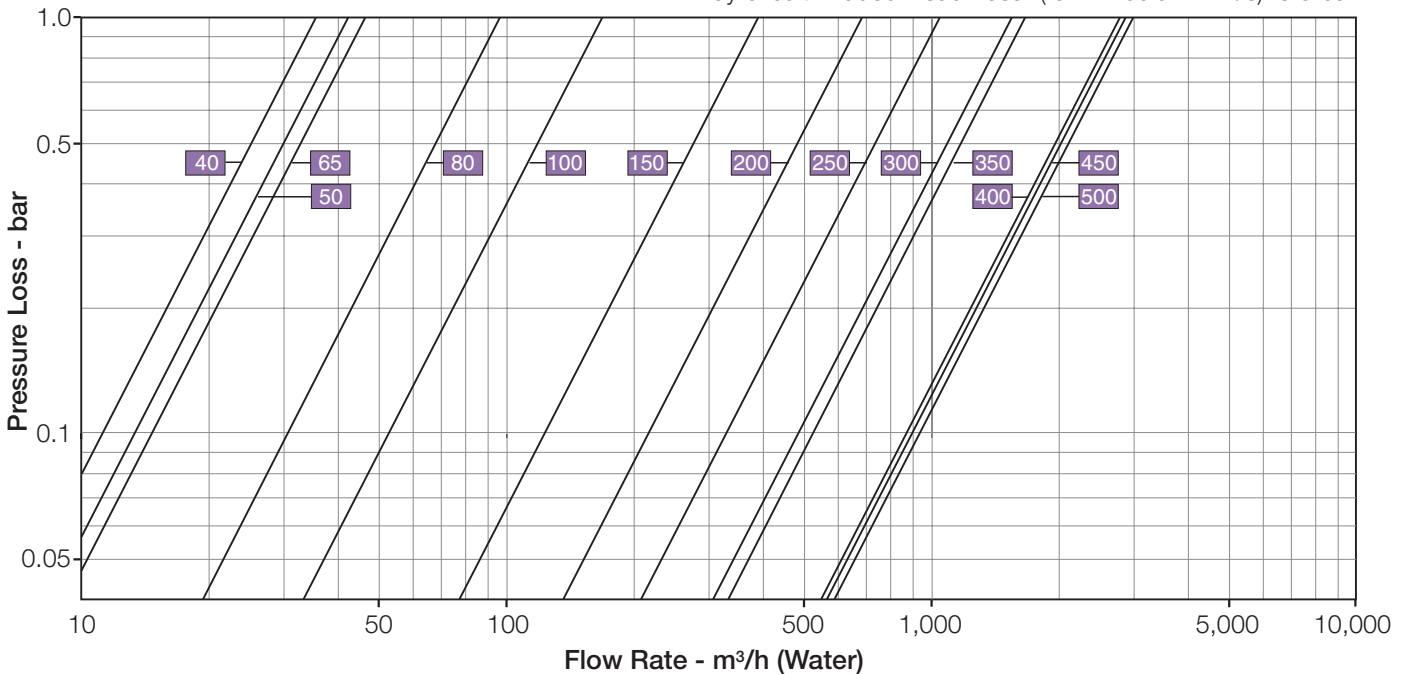

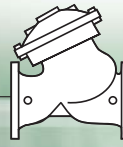

Flow Charts

SI Metric



Angle Pattern, Flat Disk

2-Way circuit "Added Head Loss" (for "V" below 2 m/s): 0.3 bar

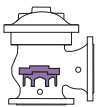
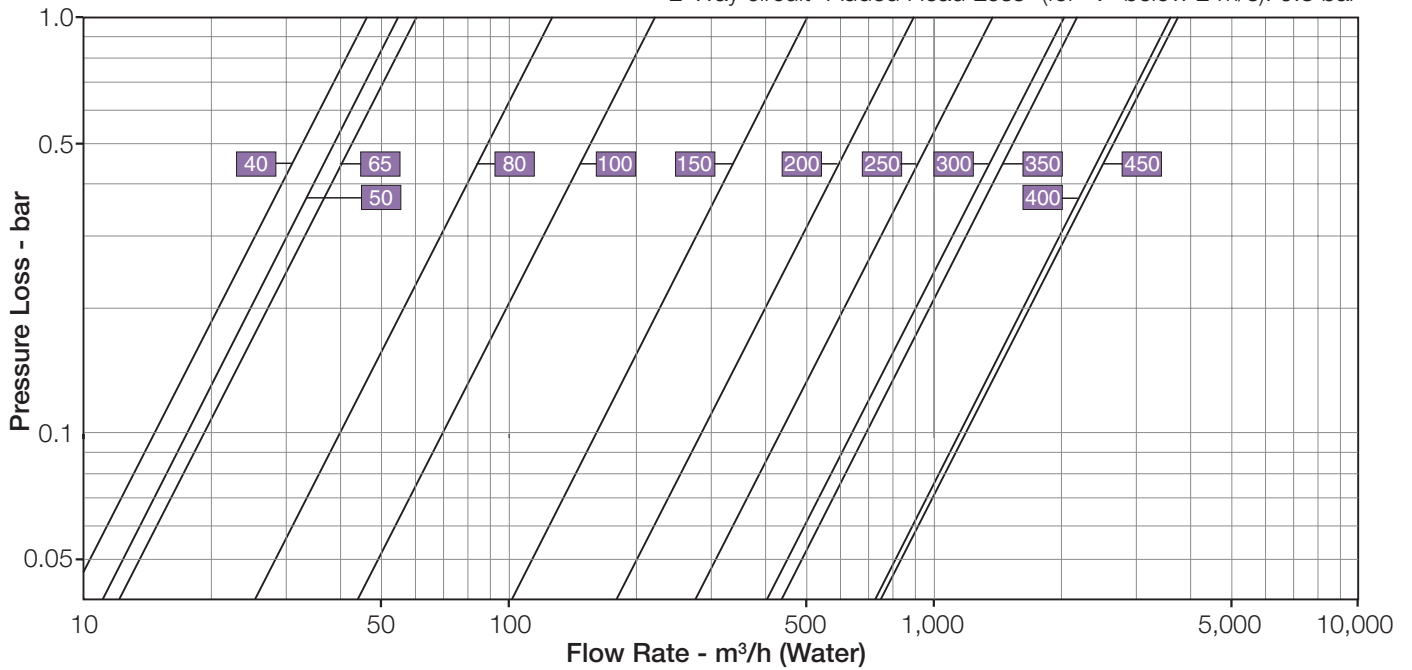

Angle Pattern, Throttling Plug (U-Type)



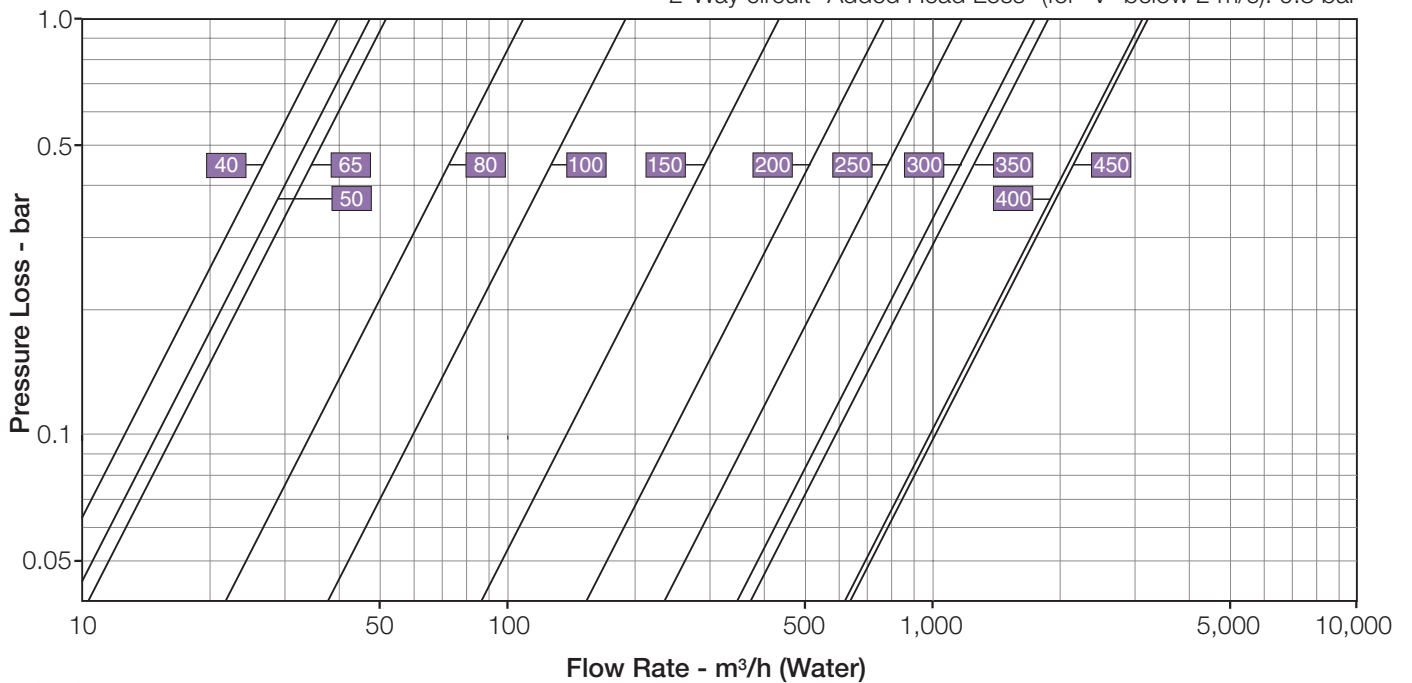

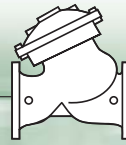
2-Way circuit "Added Head Loss" (for "V" below 2 m/s): 0.3 bar





Flow Properties

SI Metric

	mm	40	50	65	80	100	150	200	250	300	350	400	450	500
Y-Pattern Flat Disk 	Kv	42	50	55	115	200	460	815	1,250	1,850	1,990	3,310	3,430	3,550
	K	2.3	3.9	9.2	4.9	3.9	3.7	3.8	3.9	3.7	5.9	3.7	5.5	7.8
	Leq - m	4.3	10.3	33.4	21.6	23.0	37.5	53.9	70.0	85.6	159.9	112.7	204.8	323.8
Y-Pattern U-Plug 	Kv	36	43	47	98	170	391	693	1,063	1,573	1,692	2,814	2,916	3,018
	K	3.1	5.4	12.8	6.7	5.4	5.2	5.2	5.4	5.1	8.2	5.1	7.6	10.8
	Leq - m	6.0	14.3	46.2	29.9	31.9	51.9	74.6	96.8	118.4	221.3	155.9	283.5	448.1
Angle Pattern Flat Disk 	Kv	46	55	61	127	220	506	897	1,375	2,035	2,189	3,641	3,773	NA
	K	1.9	3.2	7.6	4.0	3.2	3.1	3.1	3.2	3.1	4.9	3.0	4.5	NA
	Leq - m	3.6	8.5	27.6	17.8	19.0	31.0	44.6	57.8	70.7	132.1	93.1	169.3	NA
Angle Pattern U-Plug 	Kv	39	47	51	108	187	430	762	1,169	1,730	1,861	3,095	3,207	NA
	K	2.6	4.5	10.6	5.6	4.5	4.3	4.3	4.5	4.2	6.8	4.2	6.2	NA
	Leq - m	5.0	11.8	38.2	24.7	26.4	42.9	61.7	80.0	97.9	182.9	128.9	234.3	NA

SI Metric

	mm	600	700	750	800
G-Pattern Flat Disk 	Kv	7,350	7,500	7,500	7,500
	K	3.8	6.7	8.8	11.4
	Leq - m	188.0	390.1	550.9	760.7

Valve flow coefficient, Kv or Cv

$$Kv(Cv) = Q \sqrt{\frac{G_f}{\Delta P}}$$

Where:

Kv = Valve flow coefficient (flow in m³/h at 1bar Diff. Press.)

Cv = Valve flow coefficient (flow in gpm at Diff. Press. 1psi)

Q = Flow rate (m³/h ; gpm)

ΔP = Differential pressure (bar ; psi)

G_f = Liquid specific gravity (Water = 1.0)

$$Cv = 1.155 Kv$$

Flow resistance or Head loss coefficient, $K = \Delta H \frac{2g}{V^2}$

Where:

K = Flow resistance or Head loss coefficient (dimensionless)

ΔH = Head loss (m ; feet)

V = Nominal size flow velocity (m/sec ; feet/sec.)

g = Acceleration of gravity (9.81 m/sec² ; 32.18 feet/sec²)

Equivalent Pipe Length, Leq

$$Leq = Lk \cdot D$$

Where:

Leq = Equivalent nominal pipe length (m ; feet)

Lk = Equivalent length coefficient for turbulent flow in clean commercial steel pipe (SCH 40)

D = Nominal pipe diameter (m ; feet)

Note:

The Leq values given are for general consideration only.

Actual Leq may vary somewhat with each of the valve sizes.

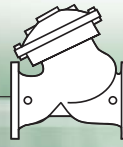

Dimensions & Weights

US 700 English

Flanged

Y Pattern

		inch	1 1/2"	2"	2 1/2"	3"	4"	6"	8"	10"	12"	14"	16"	18"	20"
	ANSI 125 ; 150	L	8.1	8.1	8.3	9.8	12.6	16.3	19.7	23.8	28.5	28.9	39.0	39.4	43.3
		W	6.1	6.1	7.0	7.9	8.8	12.6	15.4	18.9	21.7	21.7	29.1	29.1	29.1
		h	3.1	3.3	3.7	3.9	4.5	5.6	6.8	8.0	9.5	10.6	11.8	12.6	14.1
		H	9.4	9.6	10.1	12.0	14.4	19.4	23.0	28.5	33.1	34.1	43.6	44.4	45.9
	ANSI 250 ; 300	Weight (lb)	20	23	29	49	82	165	276	478	816	840	1865	2083	2121
		L	8.1	8.3	8.7	10.4	13.2	17.0	20.6	25.1	30.0	30.2	40.3	40.5	44.7
		W	6.1	6.5	7.3	8.1	9.8	12.6	15.4	18.9	21.7	22.4	29.1	29.1	29.5
		h	3.1	3.3	3.7	4.1	5.0	6.3	7.5	8.8	10.3	11.6	12.8	14.1	15.3
	ANSI 250 ; 300	H	9.4	9.6	10.1	12.4	14.9	20.0	23.7	29.2	33.8	35.2	44.6	45.9	47.1
		Weight (lb)	22	27	33	55	95	187	322	540	904	957	1984	2132	2174

Globe Pattern

		inch	24"	28"	30"	32"
	ANSI 125 ; 150	L	57	65	70	73
		W	49	49	49	49
		h	18.5	19	20.5	21.8
		H	77	78	79.3	80.6
	ANSI 250 ; 300	Weight (lb)	7150	8140	8580	9020
		L	59	65	70	73
		W	49	49	49	49
		h	18.5	19	20.5	21.8
	ANSI 250 ; 300	H	77	78	79.3	80.6
		Weight (lb)	7700	8140	8580	9020

Angle Pattern

		inch	1 1/2"	2"	2 1/2"	3"	4"	6"	8"	10"	12"	14"	16"	18"
	ANSI 125 ; 150	L	4.9	4.9	5.9	6.0	7.5	8.9	10.4	12.6	15.6	15.7	17.7	17.7
		W	6.1	6.1	7.0	7.9	8.7	12.6	15.4	18.9	21.7	21.7	29.1	29.1
		R	3.1	3.3	3.7	3.9	4.5	5.6	6.8	8.0	9.8	10.4	11.8	12.6
		h	3.3	3.3	4.3	4.0	5.0	6.0	8.0	8.6	10.7	11.0	14.5	14.5
	ANSI 250 ; 300	H	8.9	8.9	9.9	11.1	13.5	17.4	21.5	24.9	30.6	30.7	42.6	42.6
		Weight (lb)	21	22	27	47	77	157	260	452	772	816	1764	1808
		L	4.9	4.9	5.9	6.3	7.9	9.2	10.9	13.2	16.3	16.5	18.4	18.4
		W	6.5	6.5	7.3	8.1	9.8	12.6	15.4	18.9	21.7	21.7	29.1	29.1
	ANSI 250 ; 300	R	3.1	3.3	3.7	4.1	5.0	6.3	7.5	8.8	10.3	11.5	12.8	14
		h	3.3	3.3	4.3	4.3	5.3	6.5	8.5	9.3	11.6	11.8	15.2	15.2
		H	8.9	8.9	9.9	11.3	13.8	17.9	22.0	25.6	31.3	31.5	43.3	43.3
		Weight (lb)	24	25	30	51	90	179	304	514	860	937	1885	1918

Threaded

Angle Pattern

		inch	2"	2 1/2"	3"
	BSP ; NPT	L	4.8	5.5	6.3
		W	4.8	4.8	6.4
		R	1.6	1.9	2.2
		h	3.3	4.0	4.5
		H	8.9	9.5	11.6
Weight (lb)		12	15	33	

Y Pattern

		inch	1 1/2"	2"	2 1/2"	3"
	BSP ; NPT	L	6.1	6.1	8.3	9.8
		W	4.8	4.8	4.8	6.4
		h	1.6	1.6	8.2	2.2
		H	7.9	8.0	8.2	10.4
		Weight (lb)	12	12	18	37

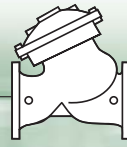

Flow Charts

US English

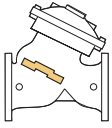

Y Pattern, Flat Disk

2-Way circuit "Added Head Loss" (for "V" below 6.5 f/s): 4.5 psi

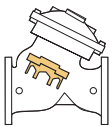
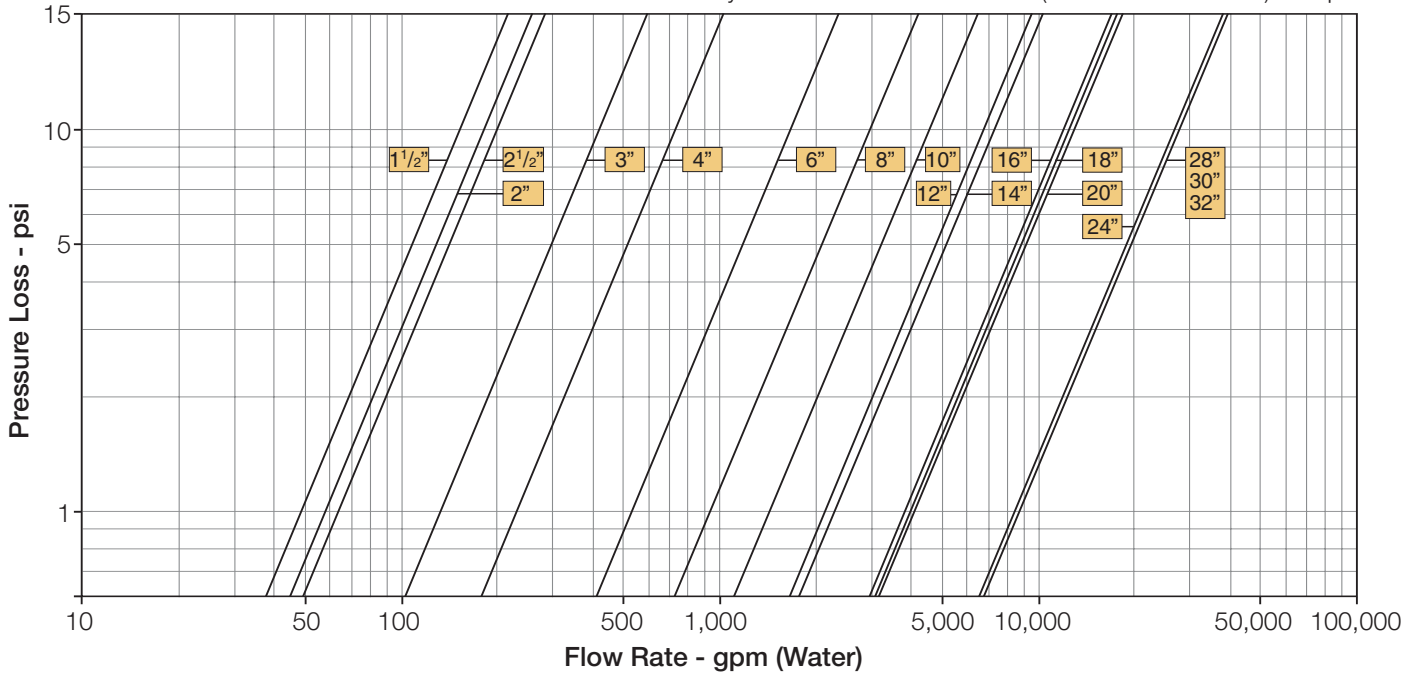

Y Pattern, Throttling Plug (U-Type)

2-Way circuit "Added Head Loss" (for "V" below 6.5 f/s): 4.5 psi

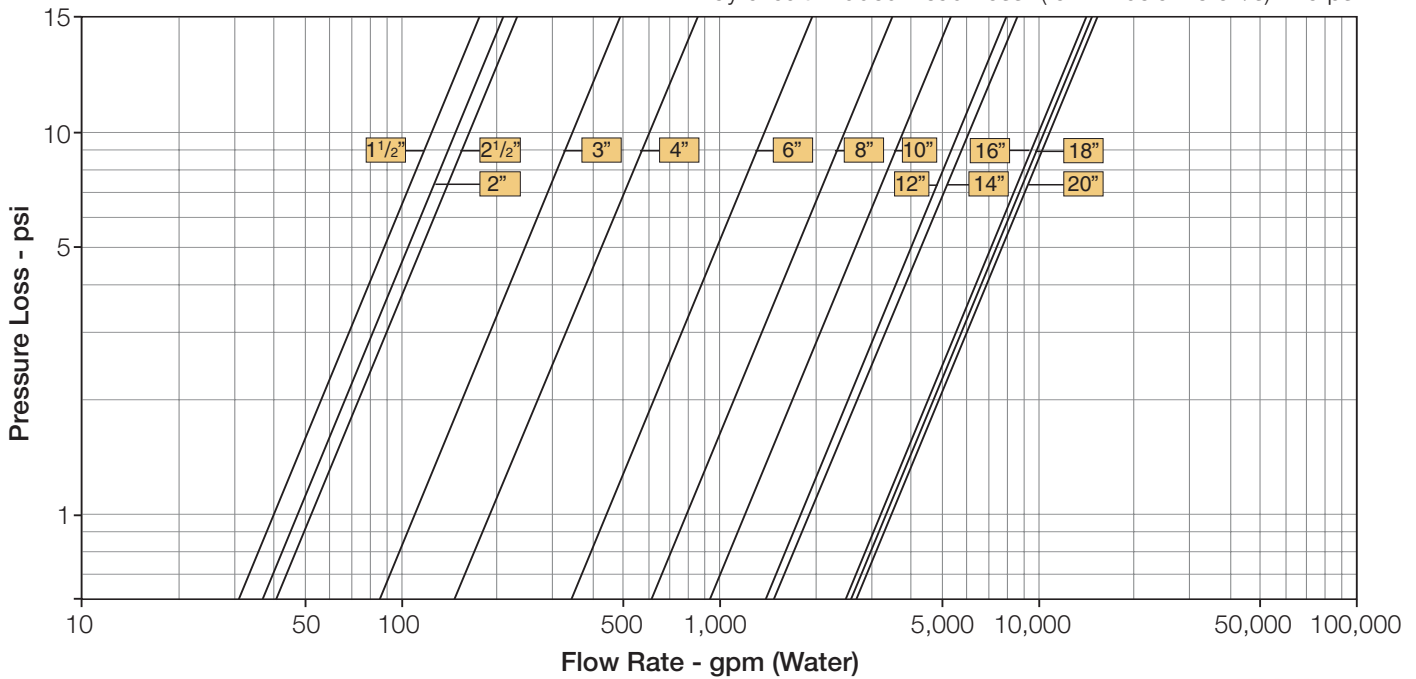

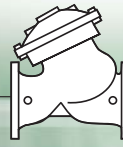

Flow Charts

US English



Angle Pattern, Flat Disk

2-Way circuit "Added Head Loss" (for "V" below 6.5 f/s): 4.5 psi

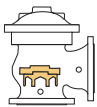
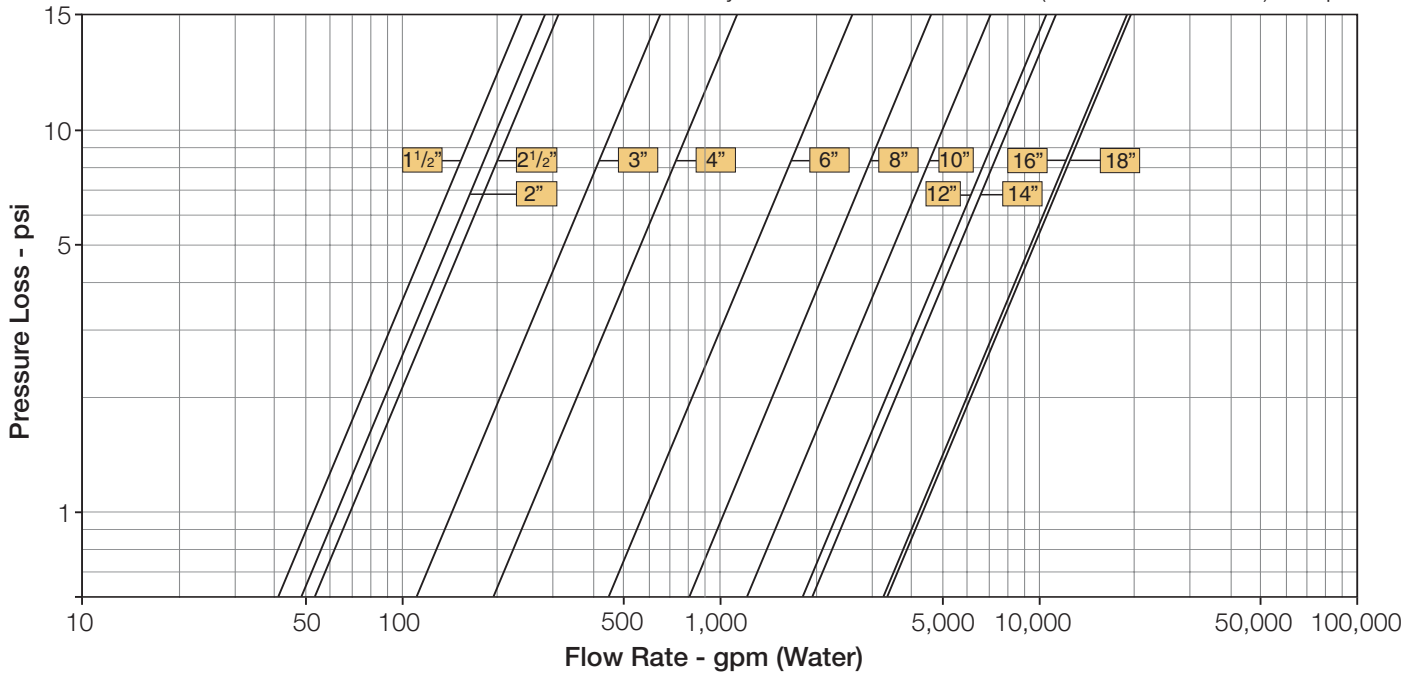

Angle Pattern, Throttling Plug (U-Type)



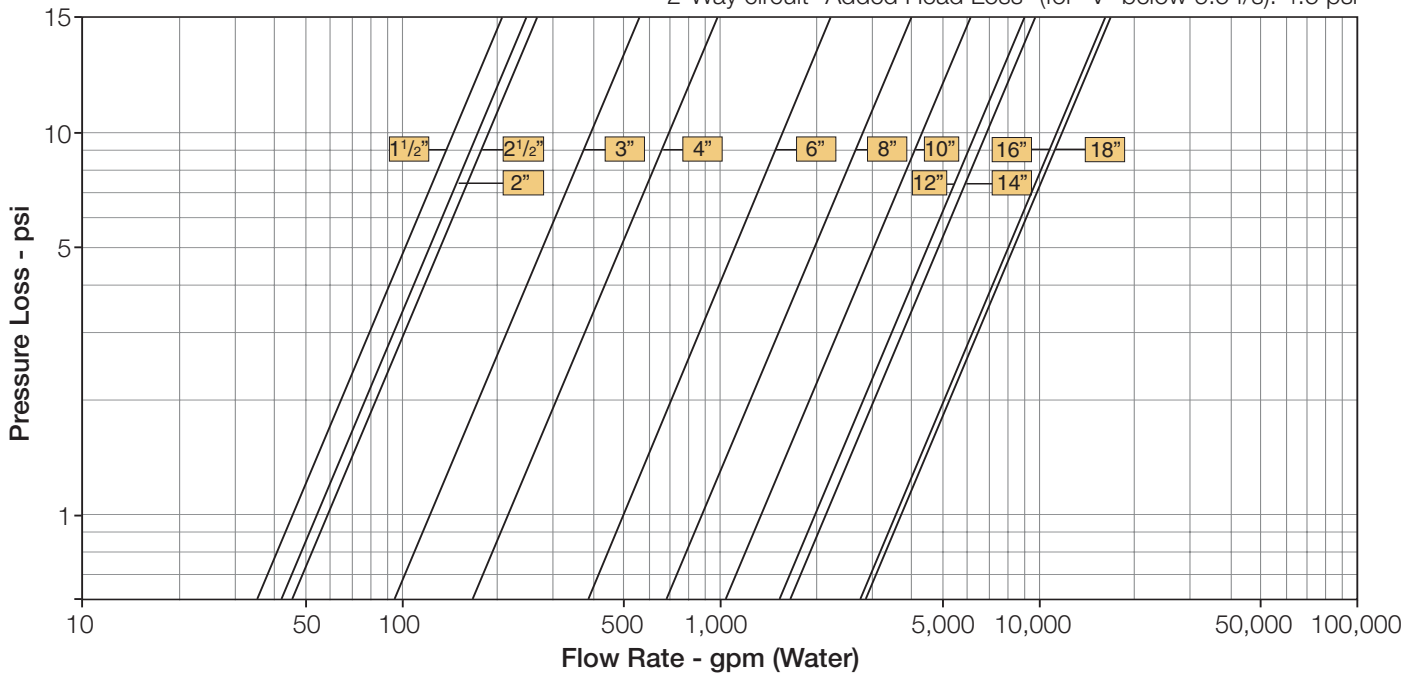

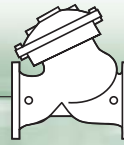
2-Way circuit "Added Head Loss" (for "V" below 6.5 f/s): 4.5 psi





Flow Properties

US English

	inch	1.5"	2"	2.5"	3"	4"	6"	8"	10"	12"	14"	16"	18"	20"
Y-Pattern Flat Disk 	Cv	49	58	64	133	230	530	940	1,440	2,140	2,300	3,820	3,960	4,100
	K	2.3	3.9	9.2	4.9	3.9	3.7	3.8	3.9	3.7	5.9	3.7	5.5	7.8
	Leq-feet	14.2	33.8	109.5	70.8	75.6	123.0	176.9	229.5	280.8	524.5	369.6	671.9	1,062.3
Y-Pattern U-Plug 	Cv	41	49	54	113	200	450	800	1,230	1,820	1,950	3,250	3,370	3,490
	K	3.1	5.4	12.8	6.7	5.4	5.2	5.2	5.4	5.1	8.2	5.1	7.6	10.8
	Leq-feet	19.7	46.8	151.6	97.9	104.6	170.2	244.8	317.6	388.6	725.9	511.6	930.0	1,470.3
Angle Pattern Flat Disk 	Cv	53	64	70	146	250	580	1,040	1,590	2,350	2,530	4,210	4,360	NA
	K	1.9	3.2	7.6	4.0	3.2	3.1	3.1	3.2	3.1	4.9	3.0	4.5	NA
	Leq-feet	11.7	28.0	90.5	58.5	62.5	101.6	146.2	189.7	232.0	433.4	305.5	555.3	NA
Angle Pattern U-Plug 	Cv	45	54	59	124	220	500	880	1,350	2,000	2,150	3,580	3,710	NA
	K	2.6	4.5	10.6	5.6	4.5	4.3	4.3	4.5	4.2	6.8	4.2	6.2	NA
	Leq-feet	16.3	38.7	125.3	80.9	86.5	140.7	202.4	262.5	321.2	599.9	422.8	768.6	NA

US English

	inch	24"	28"	30"	32"
G-Pattern Flat Disk 	Cv	8,490	8,670	8,670	8,670
	K	3.8	6.7	8.8	11.4
	Leq-feet	616.6	1,280.0	1,807.3	2,495.6

Valve flow coefficient, Kv or Cv

$$Kv(Cv) = Q \sqrt{\frac{Gf}{\Delta P}}$$

Where:

Kv = Valve flow coefficient (flow in m³/h at 1bar Diff. Press.)

Cv = Valve flow coefficient (flow in gpm at Diff. Press. 1psi)

Q = Flow rate (m³/h ; gpm)

ΔP = Differential pressure (bar ; psi)

Gf = Liquid specific gravity (Water = 1.0)

$$Cv = 1.155 Kv$$

Flow resistance or Head loss coefficient,

$$K = \Delta H \frac{2g}{V^2}$$

Where:

K = Flow resistance or Head loss coefficient (dimensionless)

ΔH = Head loss (m ; feet)

V = Nominal size flow velocity (m/sec ; feet/sec.)

g = Acceleration of gravity (9.81 m/sec² ; 32.18 feet/sec²)

Equivalent Pipe Length, Leq

$$Leq = Lk \cdot D$$

Where:

Leq = Equivalent nominal pipe length (m ; feet)

Lk = Equivalent length coefficient for turbulent flow in clean commercial steel pipe (SCH 40)

D = Nominal pipe diameter (m ; feet)

Note:

The Leq values given are for general consideration only.

Actual Leq may vary somewhat with each of the valve sizes.

Irrigation

Irrigation for Agriculture

Engineering Data

Water Meters

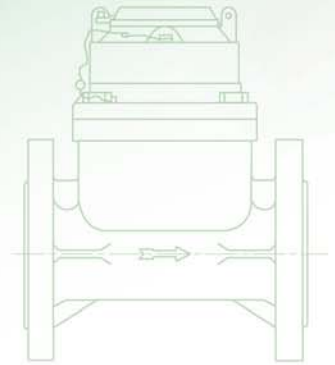
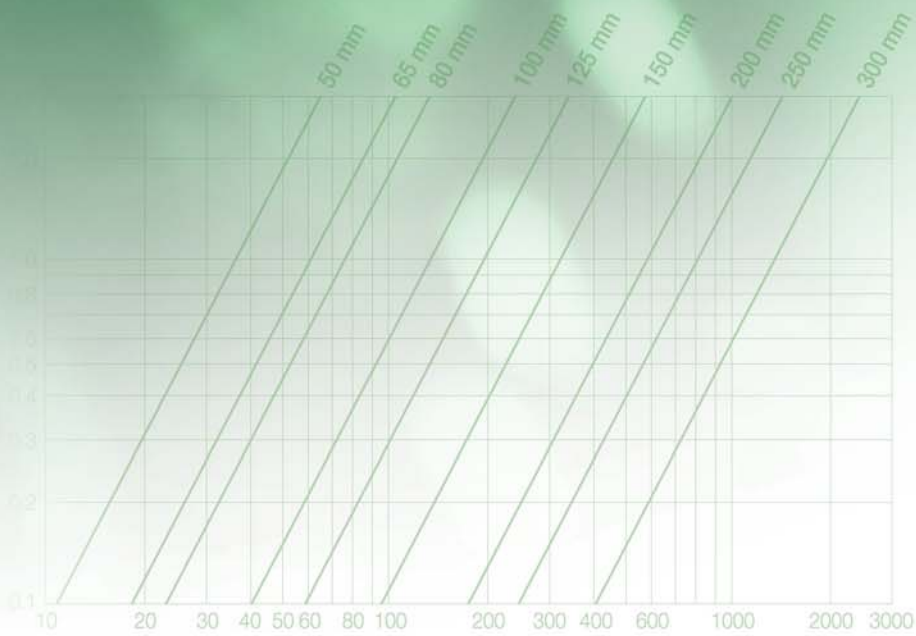

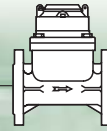

Water Meter

for Irrigation and Waste Water

Turbo-IR

Features and Benefits

- Magnetic drive
- Dry, vacuum sealed register
- Option for “reed switch” sensor
- Register can rotate 360°
- Paddle wheel design prevents jamming and damage due to solid debris
- Measuring element suits range of water meter sizes
- Easy maintenance
- Can be installed in any orientation
- Low head loss.



The TURBO-IR uses a multi-blade plastic paddle mounted at the top of the water passage, where disturbance from solids suspended in the water is minimal, permitting accuracy of metering in water containing up to 30% solid debris.

Ideal for irrigation and waste water applications.



Installations Recommendation

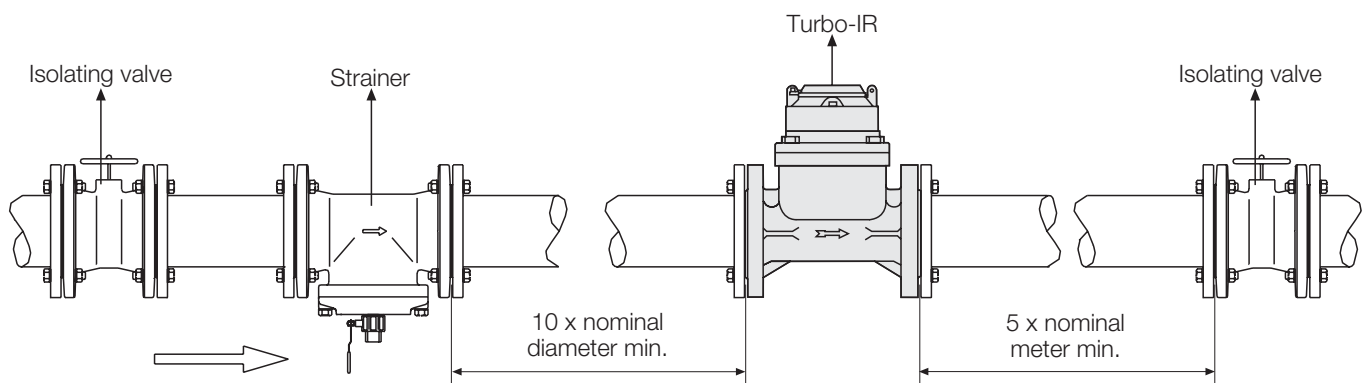

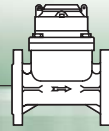

Technical Specifications

Dimensions and Weights

Size	in	2"	2 1/2"	3"	4"	5"	6"	8"	10"	12"
	DN	50	65	80	100	125	150	200	250	300
L - Length (mm)		200	200	225	250	250	300	350	450	500
H - Height (mm)		252	262	279.5	289.5	303	332.5	386	441.5	493.5
Weight (kg)		10.5	11.8	15.5	17.5	19.5	30.5	42.5	60.0	82.5

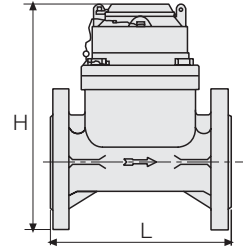

Accuracy Table

Size	in	2"	2 1/2"	3"	4"	5"	6"	8"	10"	12"	
	DN	50	65	80	100	125	150	200	250	300	
Qmax - max. Flow	(m³/h)	70	100	150	250	350	500	900	1200	1600	
Qn - Nominal Flow	(m³/h)	35	50	75	125	175	250	450	600	800	
Qt - Transition Flow	(m³/h)	10.5	15	22.5	37.5	52.5	75	135	180	240	
Qmin - Min. Flow	(m³/h)	2.8	4	6	10	14	20	35	48	64	
Maximum Reading	(m³)	9999999.99						99999999.9			
Minimum Reading	(m³)	0.01						0.1			

Accuracy Curve

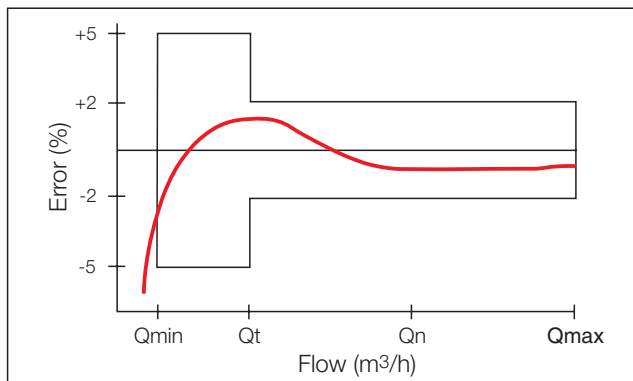

Pulse Options

DN	Reed Switch Pulse		
	1 Pulse Per		
	100 liter	1 m³	10 m³
2"-6" 50-150	X	X	
8"-12" 200-300		X	X
Order Codes	S3	S2	S1

For pulse preparation add Y/to code

Flow Curve

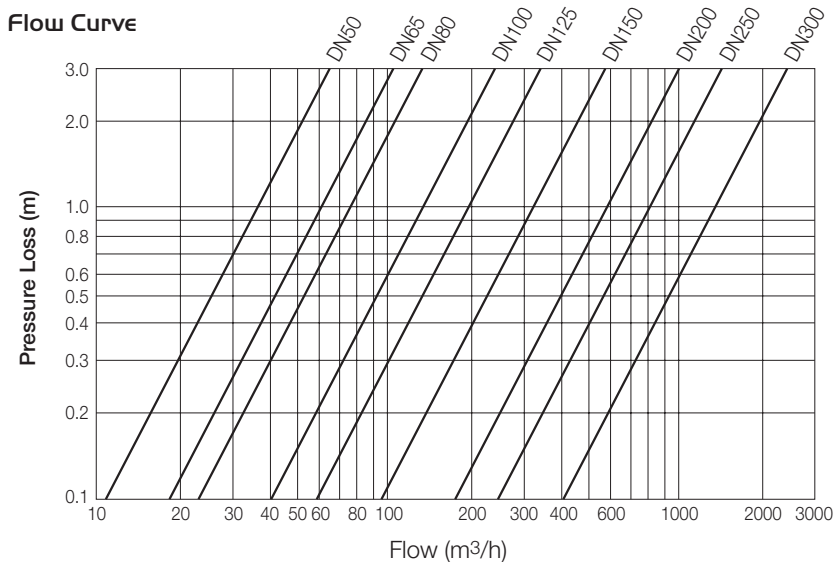

Operating Data

- **Pressure Rating:** 16 bar 232 psi
- **Temperature:** Water up to 40°C,; 105° F

Reed Switch Data

- **Cable:** 2 core, 1.5m length
- **Reed Switch:** single
- **Electrical Data:**
Switching Volt.: 24 AV/DC max.
Switching Current: 0.01A max.

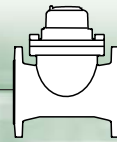

Woltman Turbine Meter

Magnetic Drive Dry Type

WPH

Heavy duty and designed to handle high flow rates, the TURBOBAR WPH-Magnetic Drive water meter covers a very wide flow range, and is particularly suited to industrial, waterworks, water distribution, water monitoring, and agricultural applications. Based on the Woltmann principle, the helical blades of the turbine rotate around the axis of flow. TURBOBAR products are long-life, and easy to maintain at low cost.



EEC CLASS B
PATTERN APPROVAL

Features and Benefits

- Removable and interchangeable measuring element
- Dry type register
 - Hermetically sealed
- Includes output option by Dry Contact (Reed Switch) and Opto-Electronic sensor, as standard
 - Digital flow converter device and a digital counter are available on request
- Magnetic transmission keeps the register completely separate from water; only the impeller and transmission shaft contact water
- Meets or exceeds ISO 4064 class B-H
- US gallons registration available on request
- EEC Approval (50-300 mm)

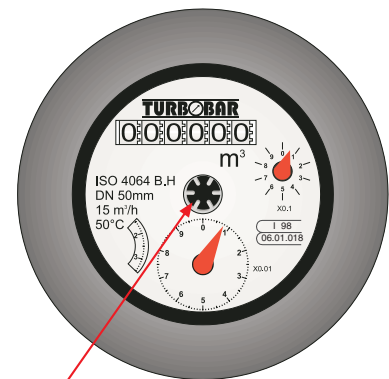

Rotating star for leak detection and electronic calibration

Installations Recommendation

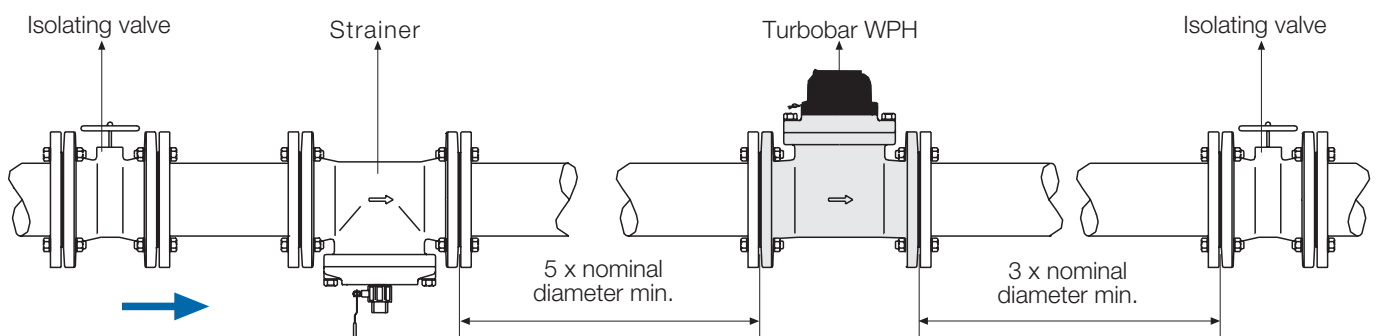

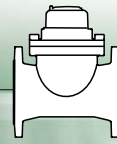

Technical Specifications

Dimensions and Weights

Size	in	1 1/2"	2"		2 1/2"	3"	4"	5"	6"	8"	10"	12"	16"	20"
	DN	40	50	50	65	80	100	125	150	200	250	300	400	500
		ISO		ANSI/BSTD										
L - Length (mm)	260	200	310	200	225	250	250	300	350	450	500	500	500	500
H - Height (mm)	200	200	200	200	200	200	200	230	230	318	318	365	410	
H ₁ - Height (mm)	370	270	270	270	270	270	270	300	300	388	388	435	480	
h - Height (mm)	68	75	70	85	95	104	118	135	162	194	216	304	355	
W - Width (mm)	160	170	160	190	200	230	250	285	340	395	445	600	700	
Weight (kg)	13	12	15	14	16	19	20	39	52	105	120	187	256	

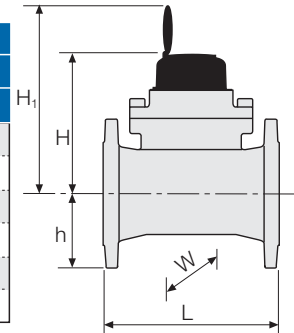

Accuracy Curve

	in	1 1/2"	2"	2 1/2"	3"	4"	5"	6"	8"	10"	12"	16"	20"	
	DN	40	50	65	80	100	125	150	200	250	300	400	500	
Q _n - Nominal flow rate (ISO 4064) (m ³ /h)		10	15	25	40	60	100	150	250	400	600	1,000	1,500	
Q _p - Max. Permanent flow (m ³ /h)		20	30	30	60	100	160	180	300	600	1,000	1,500	3,000	
Q _{max} - Max. flow rate (ISO 4064) (m ³ /h)		20	30	50	80	120	200	300	500	800	1,200	2,000	3,000	
Max. flow peak duty (m ³ /h)		30	50	80	120	200	250	300	500	800	1,500	2,500	4,000	
Q _t - Transmission flow rate (±2%) (m ³ /h)		3	3	5	8	12	20	30	50	80	120	200	300	
Q _{min} - Min. flow rate (±5%) (ISO 4064) (m ³ /h)		0.7	0.45 0.7	0.75	1.2	1.8	3	4.5	7.5	12	18	30	40	
Flow rate Δp = 0.1 bar (m ³ /h)		30	40	55	60	90	120	300	500	850	1,500	3,000	5,000	
Max. reading (m ³)		1,000,000						10,000,000			100,000,000			
Min. reading (liter)		1						10			100			

Accuracy Curve

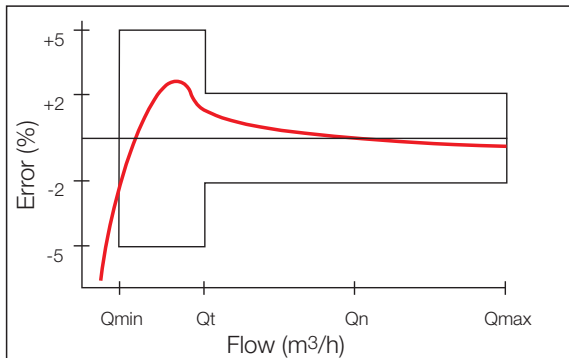

Flow Curve

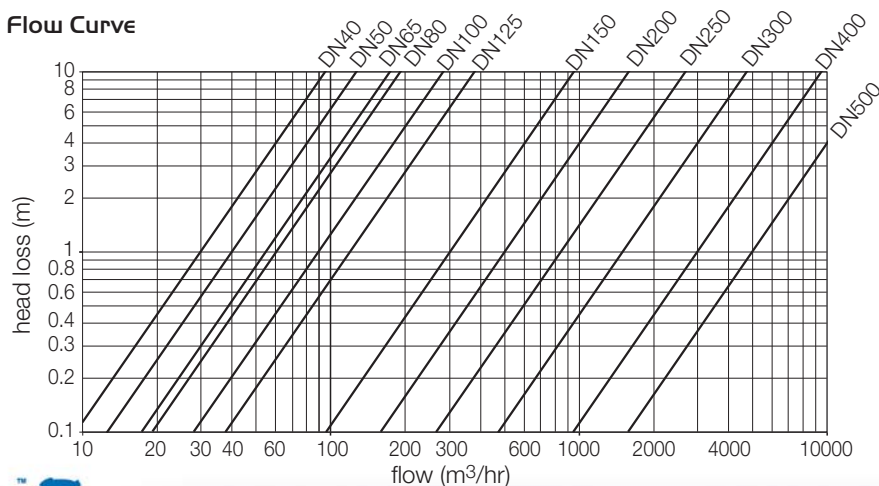

Main Operating Characteristics

- Pressure Rating: PN 16
- Temperature: 50°C

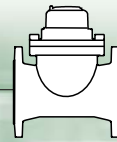

Data Output Options

Water system management requires reliable data acquisition. The TURBOBAR WPH provides accurate data acquired directly from within the system.

Pulse Generating Options

- The reed switch pulse transmitter is a magnetic on/off switch that makes and breaks electric pulse contact per each unit of flow.
- The Opto-Electronic Sensor (infrared retro-reflective photocell) produces an electric pulse with high pulse-rate capacity. The pulse is transmitted to a converter* that enables instant flow-rate readout, pulse counting, and/or 4-20 mA output.

*Converter available on request.

Data Output Options

Reed Switch

- Switching voltage: 48 VAC/DC max
- Switching current: 0.2 A max
- Switching power: 4 W max

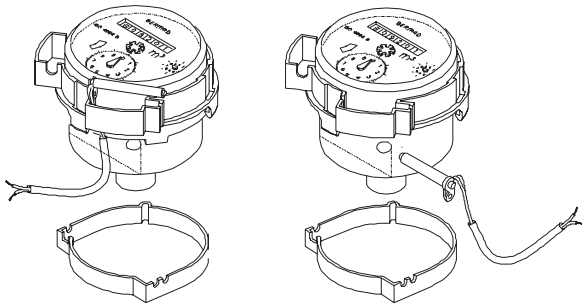

Register with Reed Switch

Opto-Electronic Sensor

- Supply voltage: 5-10 VDC
- Output type: PNP
- Output signal
 - High state: • supply voltage
 - Low state: <0.5 VDC

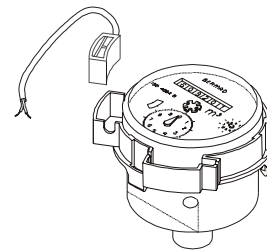

Register with Opto-Electronic Sensor

Pulse Options

Size		1 Pulse for Each							
		Reed Switch					Opto-Electronic Sensor		
In	mm	10 liter	100 liter	1 m ³	10 m ³	100 m ³	1 liter	10 liter	100 liter
1 1/2"	40	•	X	X			X		
2"	50	•	X	X			X		
2 1/2"	65	•	X	X			X		
3"	80	•	X	X			X		
4"	100	•	X	X			X		
5"	125	•	X	X			X		
6"	150		•	X	X			X	
8"	200		•	X	X			X	
10"	250		•	•	X	X		•	X
12"	300			•	X	X			X
16"	400			•	X	X			X
20"	500			•	X	X			X
Order Codes		S4	S3	S2	S1	S8	SA	SB	SC

Pulse in US gallons available on request.
All factory configured options are field accessible.

X Factory configured standard.
• Factory configured on request.

Irrigation for Agriculture

Engineering Data

IR-350 Series

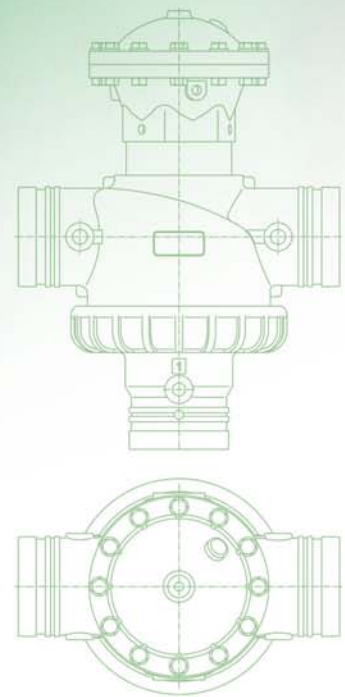
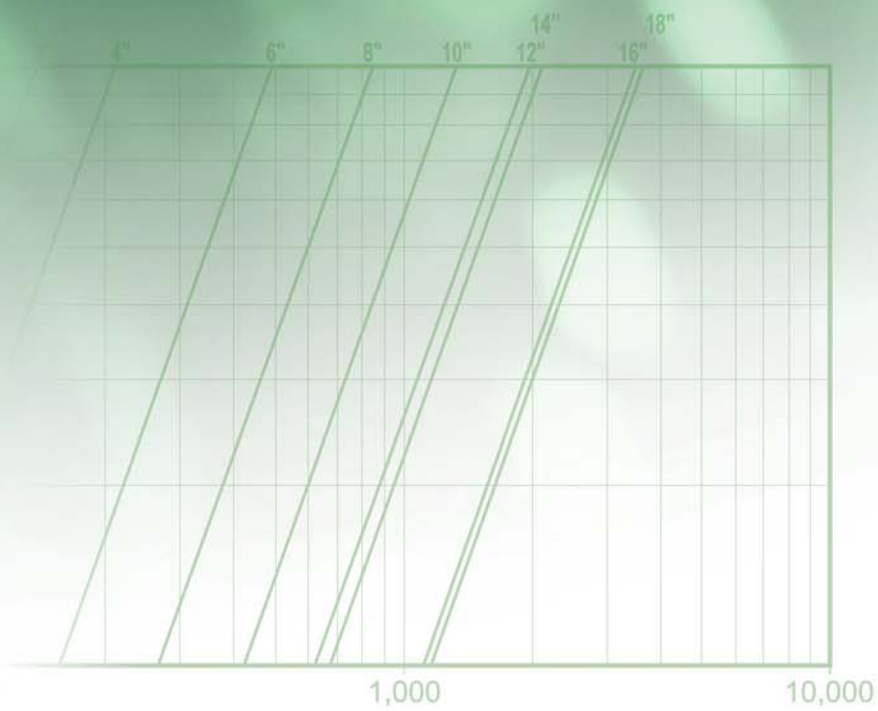

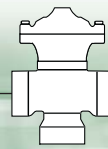

SI Metric

IR-2x2-350-P

Dimensions

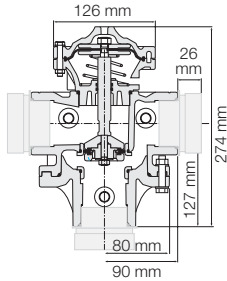

Weight: 2.8 Kg
 Note: Groove adaptors add 0.5 Kg to valve weight.

Hydraulic Data

Angle Flow	Filtartion 1⇒C	Backwash C⇒2
	Kv=52	Kv=48
Straight Flow	Filtartion 2⇒C	Backwash C⇒1
	Kv=46	Kv=60

$\Delta P = \left(\frac{Q}{Kv}\right)^2$
 Kv = m³/h @ ΔP of 1 bar
 Q = m³/h
 ΔP = bar

Technical Data

Control Chamber Displacement Volume: 0.13 liter
Operating Pressure: 0.7-10 bar
External Operating Pressure: 85%-100% of operating pressure
Maximum Temperature: 65°C
End Connections: Threaded, Grooved (with adaptors)
Flow Patterns:
 Angled Flow, Reverse Angled Flow, Straight Flow, Reverse Straight Flow

IR-2x2-350-R

Dimensions

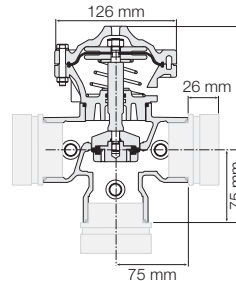

Weight: 3.7 Kg
 Note: Groove adaptors add 0.5 Kg to valve weight.

Hydraulic Data

Angle Flow	Filtartion 1⇒C	Backwash C⇒2
	Kv=55	Kv=37
Straight Flow	Filtartion 2⇒C	Backwash C⇒1
	Kv=36	Kv=58

$\Delta P = \left(\frac{Q}{Kv}\right)^2$
 Kv = m³/h @ ΔP of 1 bar
 Q = m³/h
 ΔP = bar

Technical Data

Control Chamber Displacement Volume: 0.13 liter
Operating Pressure: 0.7-10 bar
External Operating Pressure: 85%-100% of operating pressure
Maximum Temperature: 65°C
End Connections: Threaded, Grooved (with adaptors)
Flow Patterns:
 Angled Flow, Reverse Angled Flow, Straight Flow, Reverse Straight Flow

IR-3x3-350-P

Dimensions

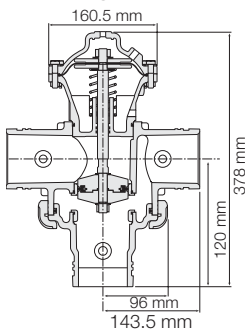

Weight: 2.8 Kg

Hydraulic Data

Angle Flow	Filtartion 1⇒C	Backwash C⇒2
	Kv=110	Kv=100
Straight Flow	Filtartion 2⇒C	Backwash C⇒1
	Kv=93	Kv=122

$\Delta P = \left(\frac{Q}{Kv}\right)^2$
 Kv = m³/h @ ΔP of 1 bar
 Q = m³/h
 ΔP = bar

Technical Data

Control Chamber Displacement Volume: 0.34 liter
Operating Pressure: 0.7-10 bar
External Operating Pressure: 85%-100% of operating pressure
Maximum Temperature: 65°C
End Connections: Grooved
Flow Patterns:
 Angled Flow, Reverse Angled Flow, Straight Flow, Reverse Straight Flow

IR-3x3-350-I

Dimensions

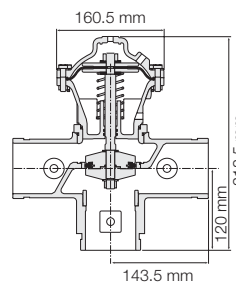

Weight: 10.5 Kg

Hydraulic Data

Angle Flow	Filtartion 1⇒C	Backwash C⇒2
	Kv=122	Kv=71
Straight Flow	Filtartion 2⇒C	Backwash C⇒1
	Kv=80	Kv=83

$\Delta P = \left(\frac{Q}{Kv}\right)^2$
 Kv = m³/h @ ΔP of 1 bar
 Q = m³/h
 ΔP = bar

Technical Data

Control Chamber Displacement Volume: 0.34 liter
Operating Pressure: 0.7-10 bar
External Operating Pressure: 85%-100% of operating pressure
Maximum Temperature: 65°C
End Connections: Grooved
Flow Patterns:
 Angled Flow, Reverse Angled Flow, Straight Flow, Reverse Straight Flow

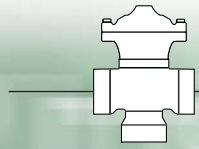

SI Metric

IR-4x3-350-A-I

Dimensions

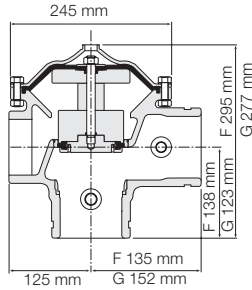

Hydraulic Data

Angle Flow	Filtration 1⇒C	Backwash C⇒2
	Kv=212	Kv=106

$$\Delta P = \left(\frac{Q}{Kv}\right)^2$$

Kv = m³/h @ ΔP of 1 bar
Q = m³/h
ΔP = bar

F= Flanged
G= Grooved
Weight:
Flanged 39.0 Kg
Grooved 21.0 Kg

Technical Data

Control Chamber Displacement Volume: 1.055 liter
Operating Pressure: 0.7-16 bar
External Operating Pressure: 100% of operating pressure
Maximum Temperature: 65°C
End Connections: Inlet & Outlet: Flanged, Grooved Drain: Threaded
Flow Pattern: Angled Flow

IR-4x4-350-A-I

Dimensions

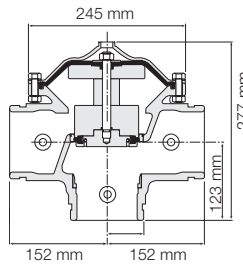

Hydraulic Data

Angle Flow	Filtration 1⇒C	Backwash C⇒2
	Kv=212	Kv=141

$$\Delta P = \left(\frac{Q}{Kv}\right)^2$$

Kv = m³/h @ ΔP of 1 bar
Q = m³/h
ΔP = bar

Weight: Grooved 22.0 Kg

Technical Data

Control Chamber Displacement Volume: 1.055 liter
Operating Pressure: 0.7-16 bar
External Operating Pressure: 100% of operating pressure
Maximum Temperature: 65°C
End Connections: Inlet & Outlet: Flanged, Grooved Drain: Threaded
Flow Pattern: Angled Flow

Operation Double Chamber

Operation

Angle Flow

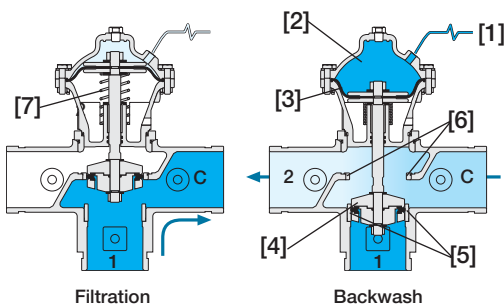

A Hydraulic Command [1], which pressurizes the Upper Control Chamber [2], forces the Diaphragm [3] actuated Plug Assembly [4] to move towards the Supply Port Seat [5], eventually sealing it drip tight. This allows flow from the filter through the Drain Port Seat [6]. Venting the upper control chamber causes the line pressure, together with the Spring [7] force, to move the Valve back to filtration mode.

Operation Single Chamber

Operation

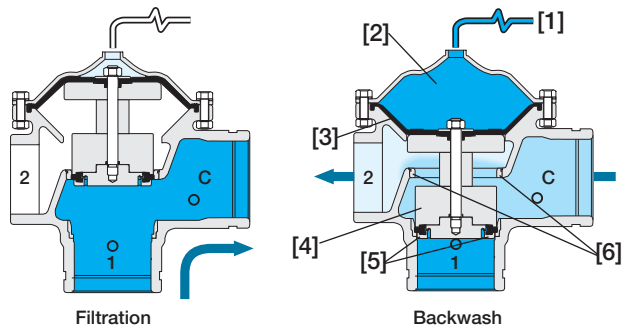

A Hydraulic Command [1], which pressurizes the Control Chamber [2], forces the Diaphragm [3] actuated Plug Assembly [4] to move towards the Supply Port Seat [5], eventually sealing it drip tight. This allows flow from the filter through the Drain Port Seat [6]. During Valve closing, the Plug [7] blocks the drain port seat, preventing mixing of supply water with waste water. Venting the control chamber causes the line pressure to move the Valve back to filtration mode.

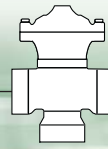

English

IR-2x2-350-P

Dimensions

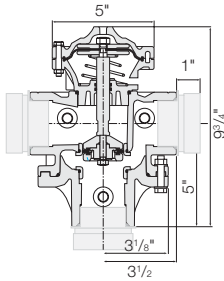

Weight: 6.2 lbs.
Note: Groove adaptors add 1.1 lbs. to valve weight.

Hydraulic Data

Angle Flow	Filtration 1⇒C	Backwash C⇒2
	 Cv=60	 Cv=56
Straight Flow	Filtration 2⇒C	Backwash C⇒1
	 Cv=53	 Cv=70

$\Delta P = \left(\frac{Q}{Cv}\right)^2$
Cv = gpm @ ΔP of 1 psi
Q = gpm
ΔP = psi

Technical Data

Control Chamber Displacement Volume: 0.04 gallon
Operating Pressure: 10-145 psi
External Operating Pressure: 85%-100% of operating pressure
Maximum Temperature: 150°F
End Connections: Threaded, Grooved (with adaptors)
Flow Patterns:
Angled Flow, Reverse Angled Flow, Straight Flow, Reverse Straight Flow

IR-2x2-350-R

Dimensions

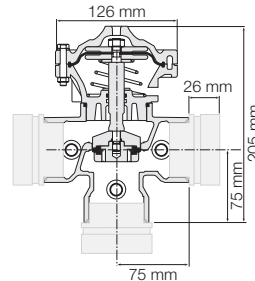

Weight: 8.2 lbs.
Note: Groove adaptors add 1.1 lbs. to valve weight.

Hydraulic Data

Angle Flow	Filtration 1⇒C	Backwash C⇒2
	 Cv=64	 Cv=43
Straight Flow	Filtration 2⇒C	Backwash C⇒1
	 Cv=42	 Cv=67

$\Delta P = \left(\frac{Q}{Cv}\right)^2$
Cv = gpm @ ΔP of 1 psi
Q = gpm
ΔP = psi

Technical Data

Control Chamber Displacement Volume: 0.04 gallon
Operating Pressure: 10-145 psi
External Operating Pressure: 85%-100% of operating pressure
Maximum Temperature: 150°F
End Connections: Threaded, Grooved (with adaptors)
Flow Patterns:
Angled Flow, Reverse Angled Flow, Straight Flow, Reverse Straight Flow

IR-3x3-350-P

Dimensions

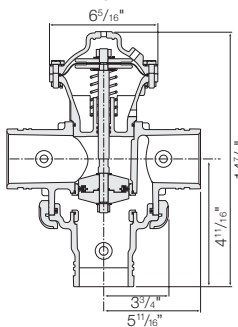

Weight: 6.2 lbs.

Hydraulic Data

Angle Flow	Filtration 1⇒C	Backwash C⇒2
	 Cv=127	 Cv=115
Straight Flow	Filtration 2⇒C	Backwash C⇒1
	 Cv=107	 Cv=141

$\Delta P = \left(\frac{Q}{Cv}\right)^2$
Cv = gpm @ ΔP of 1 psi
Q = gpm
ΔP = psi

Technical Data

Control Chamber Displacement Volume: 0.09 gallon
Operating Pressure: 10-145 psi
External Operating Pressure: 85%-100% of operating pressure
Maximum Temperature: 150°F
End Connections: Grooved
Flow Patterns:
Angled Flow, Reverse Angled Flow, Straight Flow, Reverse Straight Flow

IR-3x3-350-I

Dimensions

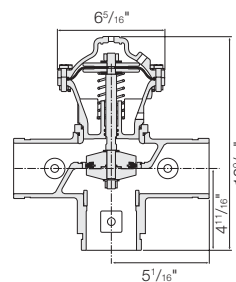

Weight: 23.1 lbs.

Hydraulic Data

Angle Flow	Filtration 1⇒C	Backwash C⇒2
	 Kv=141	 Kv=82
Straight Flow	Filtration 2⇒C	Backwash C⇒1
	 Kv=92	 Kv=96

$\Delta P = \left(\frac{Q}{Kv}\right)^2$
Kv = gpm @ ΔP of 1 psi
Q = gpm
ΔP = psi

Technical Data

Control Chamber Displacement Volume: 0.09 gallon
Operating Pressure: 10-145 psi
External Operating Pressure: 85%-100% of operating pressure
Maximum Temperature: 150°F
End Connections: Grooved
Flow Patterns:
Angled Flow, Reverse Angled Flow, Straight Flow, Reverse Straight Flow

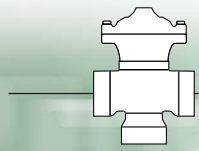

IR-4x3-350-A-I

Dimensions

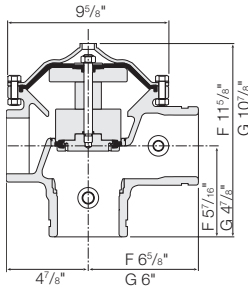

Hydraulic Data

Angle Flow	Filtration 1⇒C	Backwash C⇒2
	Cv=245	Cv=122

$$\Delta P = \left(\frac{Q}{Cv}\right)^2 \Delta$$

Cv = gpm @ ΔP of 1 psi

Q = gpm

ΔP = psi

F= Flanged

G= Grooved

Weight:

Flanged 86.0 lbs.

Grooved 46.3 lbs

Technical Data

Control Chamber Displacement Volume: 0.29 gallon

Operating Pressure: 10-232 psi

External Operating Pressure: 100% of operating pressure

Maximum Temperature: 150°F

End Connections: Inlet & Outlet: Flanged, Grooved Drain: Threaded

Flow Pattern: Angled Flow

IR-4x4-350-A-I

Dimensions

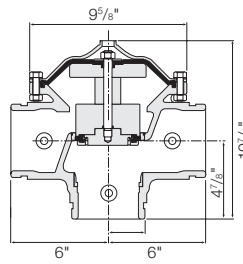

Hydraulic Data

Angle Flow	Filtration 1⇒C	Backwash C⇒2
	Cv=245	Cv=163

$$\Delta P = \left(\frac{Q}{Cv}\right)^2$$

Cv = gpm @ ΔP of 1 psi

Q = gpm

ΔP = psi

Weight: Grooved 48.5 lbs.

Technical Data

Control Chamber Displacement Volume: 0.29 gallon

Operating Pressure: 10-232 psi

External Operating Pressure: 100% of operating pressure

Maximum Temperature: 150°F

End Connections: Inlet & Outlet: Flanged, Grooved Drain: Threaded

Flow Pattern: Angled Flow

Operation Double Chamber

Operation

Angle Flow

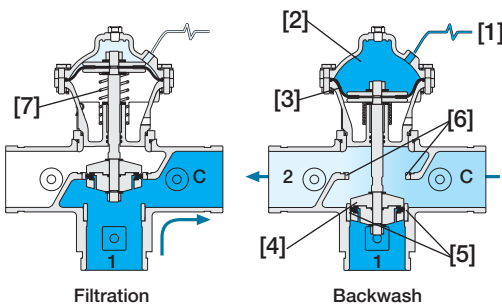

A Hydraulic Command [1], which pressurizes the Upper Control Chamber [2], forces the Diaphragm [3] actuated Plug Assembly [4] to move towards the Supply Port Seat [5], eventually sealing it drip tight. This allows flow from the filter through the Drain Port Seat [6]. Venting the upper control chamber causes the line pressure, together with the Spring [7] force, to move the Valve back to filtration mode.

Operation Single Chamber

Operation

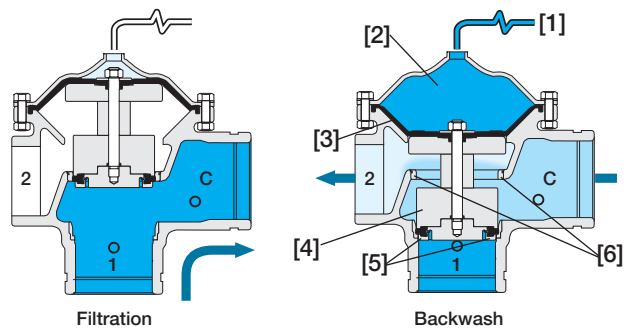

A Hydraulic Command [1], which pressurizes the Control Chamber [2], forces the Diaphragm [3] actuated Plug Assembly [4] to move towards the Supply Port Seat [5], eventually sealing it drip tight. This allows flow from the filter through the Drain Port Seat [6]. During Valve closing, the Plug [7] blocks the drain port seat, preventing mixing of supply water with waste water. Venting the control chamber causes the line pressure to move the Valve back to filtration mode.

Irrigation for Agriculture

Engineering Data

IR-200 Series

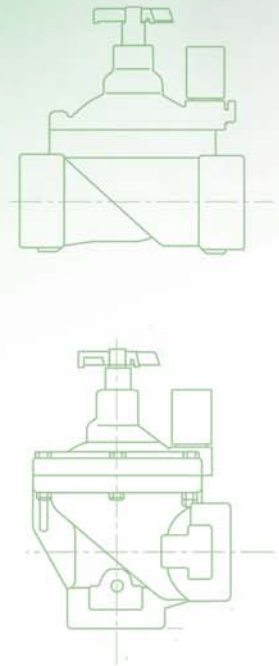
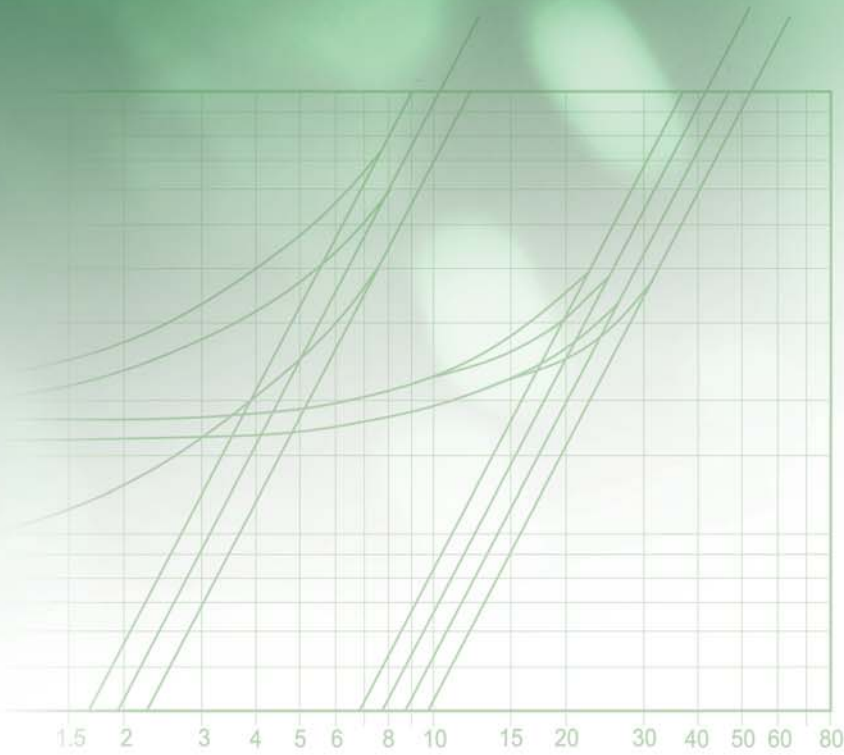

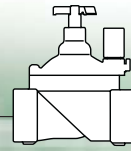

Product Parts Features, Hydraulic Valve

[1] Fastening Bolts & Nuts

6 Stainless Steel bolts and nuts (1½-2"; DN40-50 valves) fasten valve cover to body, ensuring quick in-line inspection and service.

[2] Valve Cover (Hydraulic Type)

Simple and light construction enables quick in-line inspection and service.

[2.1] Flow Stem (Optional)

[3] Auxiliary Closing Spring

One single spring fully meets valve requirements for operating pressure range, ensuring low opening pressure and secured closing.

[4] Seal Disk Assembly (Hydraulic Type)

The seal disk assembly includes a flexible, carefully balanced, and peripherally supported diaphragm and a rugged guided plug with elastomeric sealing surface. This internal design enables:

- High flow rate with low head loss
- Smooth valve opening and closing
- Accurate and stable regulation
- Low opening and actuation pressure
- No diaphragm erosion and distortion
- Same diaphragm and spring fully meet the valve's operating pressure range requirements

[5] Diaphragm Supporting Ring

[6] Valve Body (Hydraulic Type)

Glass-Filled Nylon to meet rough service conditions obtaining high chemical and cavitation resistance. Full bore seat with unobstructed flow path, free of any in-line ribs, supporting cage, or shafts.

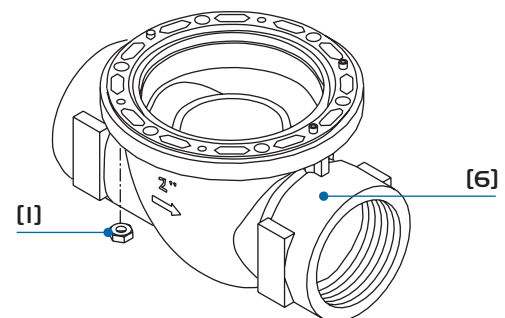
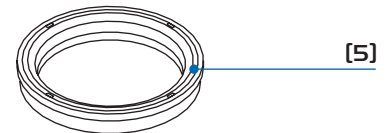
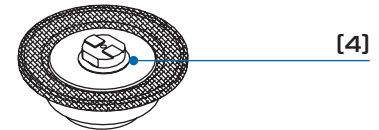
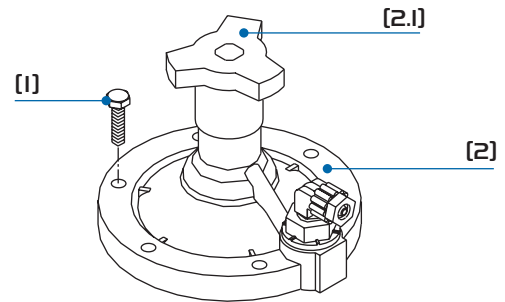

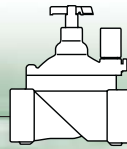

Product Parts Features, Electric Valve

[1] **Fastening Bolts & Nuts**

6 Stainless Steel bolts and nuts (1 1/2"-2"; DN40-50 valves) fasten valve cover to body, ensuring quick in-line inspection and service.

[2] **Valve Cover (Electric Type)**

Simple and light construction enables quick in-line inspection and service.

[2.1] 2-Way Solenoid Actuator

[2.2] Manuale Override Handle

[2.3] Needle - Restricts inlet flow & eliminates internal restriction clogging.

[2.4] Flow Stem (optional)

[3] **Auxiliary Closing Spring**

One single spring fully meets valve requirements for operating pressure range, ensuring low opening pressure and secured closing.

[4] **Seal Disk Assembly (Electric Type)**

The seal disk assembly includes a flexible, carefully balanced, and peripherally supported diaphragm and a rugged guided plug with elastomeric sealing surface. This internal design enables:

- High flow rate with low head loss
- Smooth valve opening and closing
- Accurate and stable regulation
- Low opening and actuation pressure
- No diaphragm erosion and distortion
- Same diaphragm and spring fully meet the valve's operating pressure range requirements

[4.1] Internal Restriction

[5] **Diaphragm Supporting Ring**

[6] **Valve Body (Electric Type)**

Glass-Filled Nylon to meet rough service conditions obtaining high chemical and cavitation resistance. Full bore seat with unobstructed flow path, free of any in-line ribs, supporting cage, or shafts.

[6.1] Internal Control Circuit Outlet

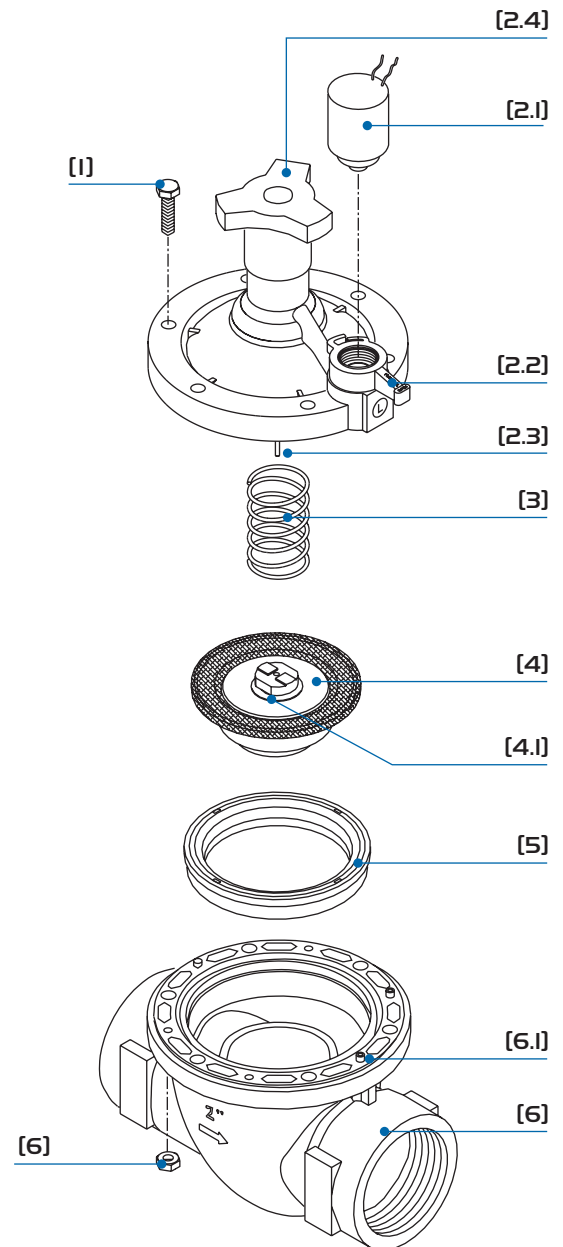

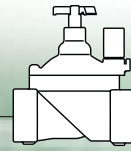

Technical Data



Dimensions & Weights

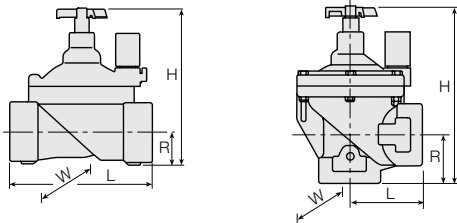

Pattern Size	Globe				Angle	
	DN20	DN25	DN40	DN50	DN40	DN50
L (mm)	110	110	160	170	80	85
H (mm)	115	115	180	190	190	210
R (mm)	22	22	35	38	40	60
W (mm)	78	78	125	125	125	125
Weight*(kg)	0.35	0.33	1.0	1.1	0.95	0.91
CCDV**(lit)	0.015	0.015	0.072	0.072	0.072	0.072

* Without flow control handle

**Control Chamber Displacement Volume (liter)

Technical Specifications

Available Patterns & Sizes:

Globe: DN: 20, 25, 40 & 50

Angle: DN: 40 & 50

Available End Connections:

BSP-T; NPT female threads

Pressure Rating: 10 bar

Operating Pressure Range: 0.7-10 bar

Temperature: Water up to 60°C

Standard Materials:

- Body & Cover: Nylon Reinforced
- Metal Parts: Stainless Steel
- Diaphragm: Natural Rubber
- Seals: NBR [Buna-N]
- Spring: Stainless Steel
- Cover bolts: Stainless Steel

Flow Chart

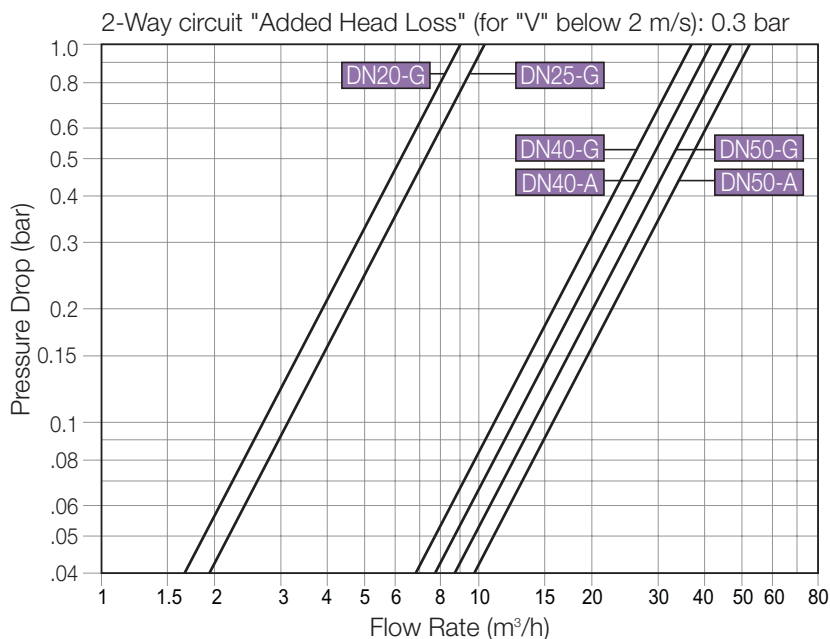

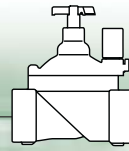

Technical Data



Dimensions & Weights

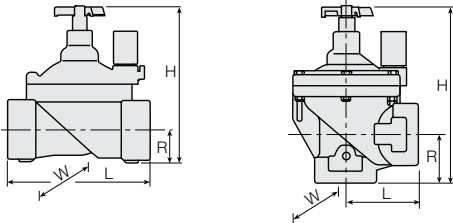

Pattern Size	Globe				Angle	
	1/2"	1"	1 1/2"	2"	1 1/2"	2"
L (inch)	45/16	45/16	65/16	611/16	33/16	33/8
H (inch)	4 1/2	4 1/2	7 1/8	7 1/2	7 1/2	8 1/4
R (inch)	7/8	7/8	1 3/8	1 1/2	19/16	2 3/8
W (inch)	3 1/16	3 1/16	4 15/16	4 15/16	4 5/16	4 15/16
Weight* (lb)	0.77	0.73	2.2	2.4	2.1	2.0
CCDV** (gal)	0.004	0.004	0.02	0.02	0.02	0.02

* Without flow control handle

**Control Chamber Displacement Volume (gallons)

Technical Specifications

Available Patterns & Sizes:

Globe: 3/4", 1", 1 1/2", 2"

Angle: 1 1/2", 2"

Available End Connections:

BSP-T; NPT female threads

Pressure Rating: 150 psi

Operating Pressure Range: 10-150 psi

Temperature: Water up to 140°F

Standard Materials:

- Body & Cover: Nylon Reinforced
- Metal Parts: Stainless Steel
- Diaphragm: Natural Rubber
- Seals: NBR [Buna-N]
- Spring: Stainless Steel
- Cover bolts: Stainless Steel

Flow Chart

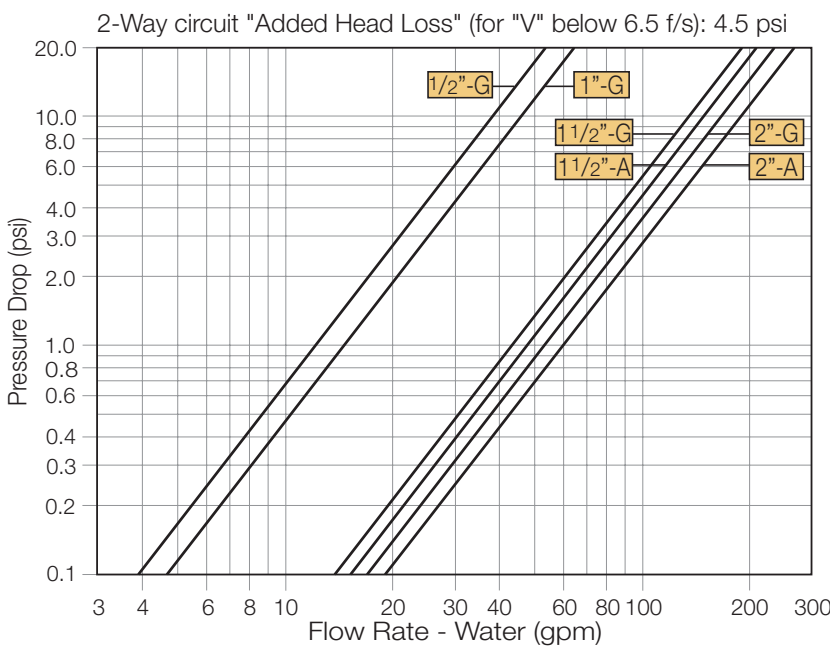

Irrigation

Irrigation for Agriculture

Engineering Data

IR-300 Series

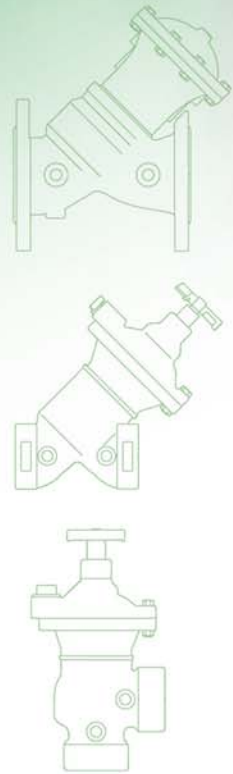
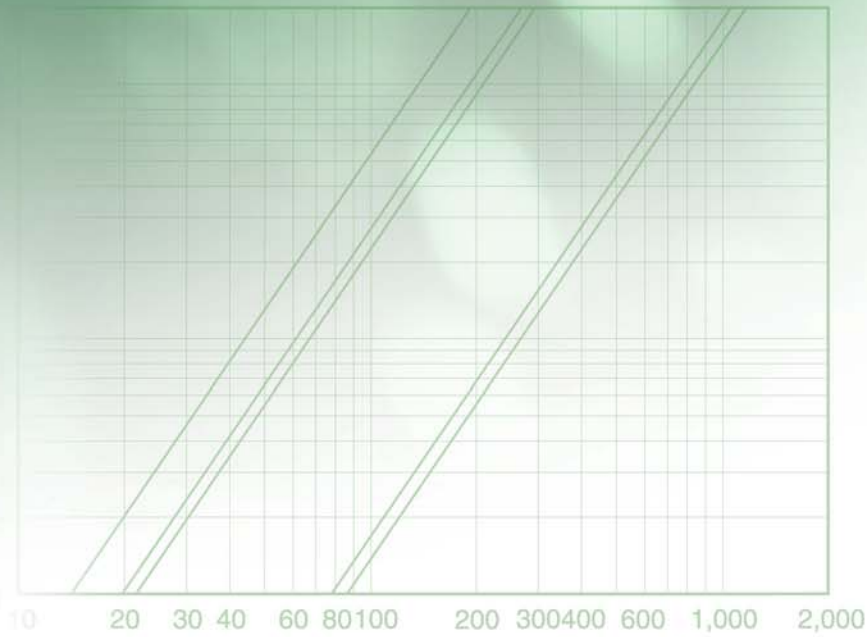

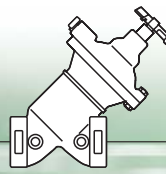

Product Parts Features

[1] Double Chambered Actuator

- Actuator assembly can be removed as one integral unit
- Simple on-site conversion to single chambered

[2] Cover Assembly

- [2.1] Optional cover type is capable of accepting a Flow Stem

[3] Diaphragm Assembly

The flexible nylon reinforced diaphragm is supported over the majority of its surface. Diaphragm load is limited to only the stretching forces applied to the active area.

[4] Inherent Separation Partition

The inherent separation provides complete central guiding for the valve moving assembly. The separation partition separates the lower control chamber from the flow in both the single chambered, and the double chambered configurations.

[5] Springs

Due to its superior hydraulic closing force, the double chambered actuator does not require an auxiliary closing spring, which is required for single chambered configurations.

An auxiliary opening spring can be applied for near zero-pressure applications with external control pressure.

- [5.1] Lifting Spring (for zero or near zero pressure applications)
- [5.2] Auxiliary Closing Spring (for single chambered valves only)

[6] Vulcanized Seal Disk

Self-aligning seal disk provides balanced, free movement and a resilient seal for perfect, drip tight sealing. The Seal disk is harnessed to the valve shaft by a stainless steel split pin.

Raised, full bore, clear of obstructions; no ribs or stem guides

[8] Valve Body ("Y" or Angle pattern)

Hydro-dynamically designed for efficient flow with minimal pressure loss. Semi-Straight flow increases capacity by 25% over standard globe valves.

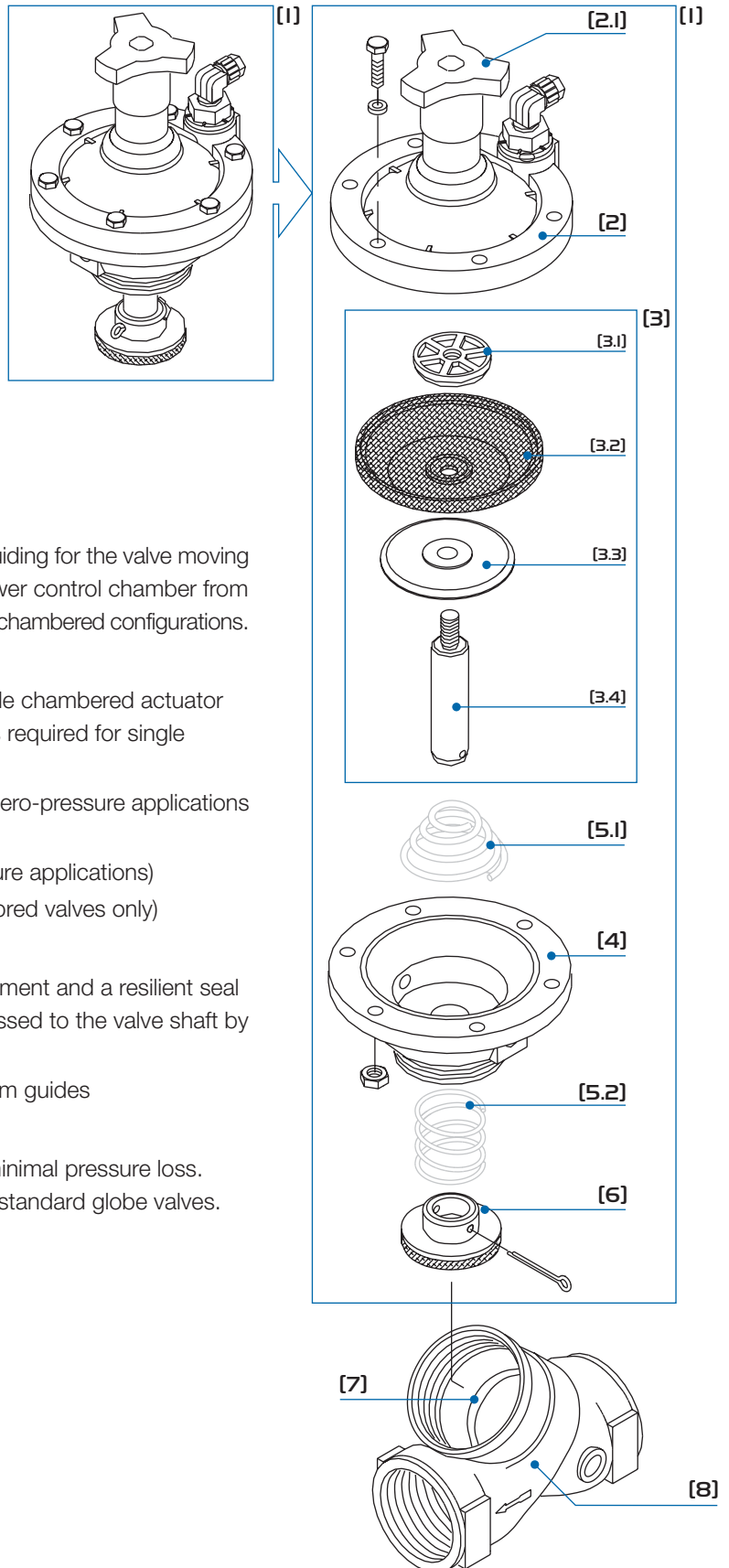

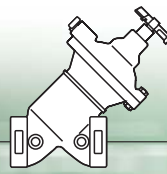

Technical Data



Dimensions & Weights

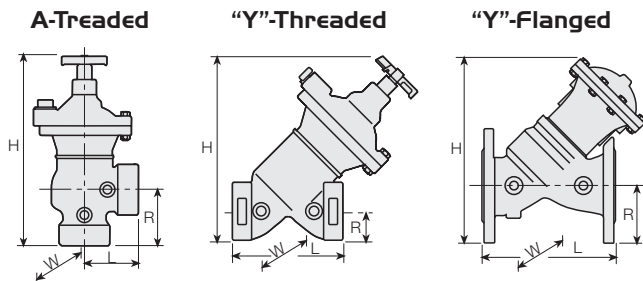

Connections Size	Threaded				Flanged
	40	50	50 Angle	80	80
L (mm)	112	124	71	210	235
H (mm)	175	215	256	275	325
R (mm)	105	125	135	160	200
W (mm)	30	40	75	58	98
Weight (kg)	1.25	2.0	2.25	7.4	14.7
CCDV* (lit)	0.045	0.092	0.092	0.246	0.246

*Control Chamber Displacement Volume

Temperature Range:

Water up to 60°F

Standard Materials:

- Body: DN40 & 50 - Brass
DN80 - Polyester Coated Cast Iron
- Actuator: Plastic, Brass & Stainless Steel
- Diaphragm: Nylon Fabric Reinforced Natural Rubber
- Seals: NBR [Buna-N] & NR
- Spring: Stainless Steel
- Cover Bolts: Stainless Steel

Technical Specifications

Available Patterns & Sizes:

"Y": DN: 40, 50 & 80

Angle: DN50

End Connections:

Threaded: DN: 40, 50 & 80

Flanged: DN80

Pressure Rating: 10 bar

Operating Pressure Range: 0.7-10 bar

Flow Chart

2-Way circuit "Added Head Loss" (for "V" below 2 m/s): 0.3 bar

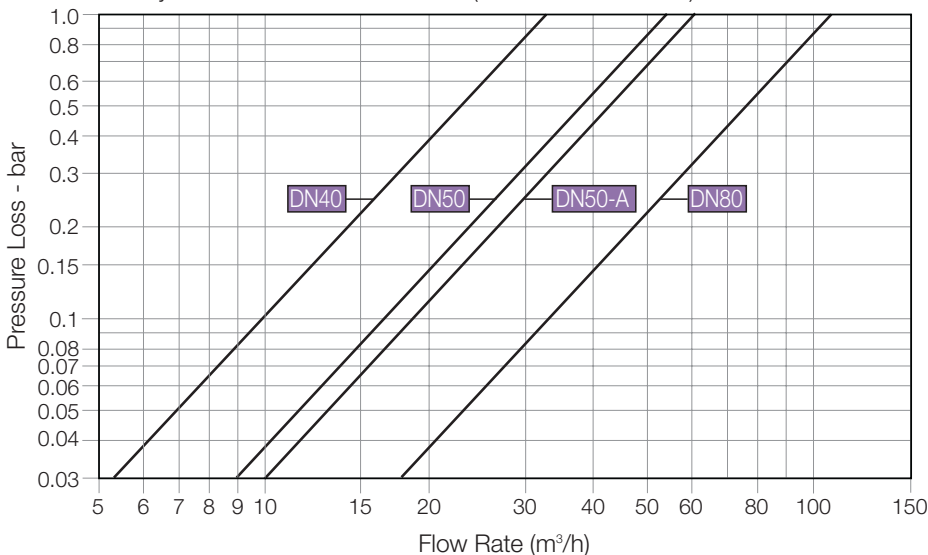

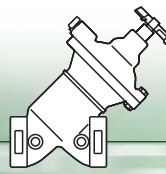

Technical Data



Dimensions & Weights

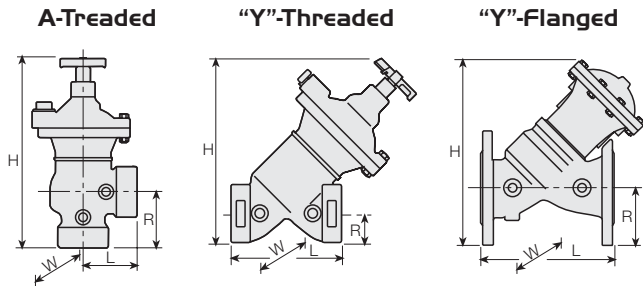

Pattern	Threaded			Flanged	
	1 1/2"	2"	2" Angle	3"	3"
L (mm)	47/16	47/8	213/16	81/4	91/4
H (mm)	67/8	87/16	101/16	1013/16	1213/16
R (mm)	41/8	415/16	55/16	65/16	77/8
W (mm)	13/16	19/16	215/16	25/16	37/8
Weight (lb)	2.75	4.4	5.0	16.3	32.4
CCDV* (gal)	0.012	0.024	0.024	0.065	0.065

*Control Chamber Displacement Volume

Temperature Range:

Water up to 140°F

Standard Materials:

- Body: 1 1/2" & 2" - Brass
3" - Polyester Coated Cast Iron
- Actuator: Plastic, Brass & Stainless Steel
- Diaphragm: Nylon Fabric Reinforced Natural Rubber
- Seals: NBR [Buna-N] & NR
- Spring: Stainless Steel
- Cover Bolts: Stainless Steel

Technical Specifications

Available Patterns & Sizes:

"Y": 1 1/2", 2" & 3"

Angle: 2"

End Connections:

Threaded: 1 1/2", 2" & 3"

Flanged: 3"

Pressure Rating:

145 psi

Operating Pressure Range:

10-145 psi

Flow Chart

2-Way circuit "Added Head Loss" (for "V" below 6.5 f/s): 4.5 psi

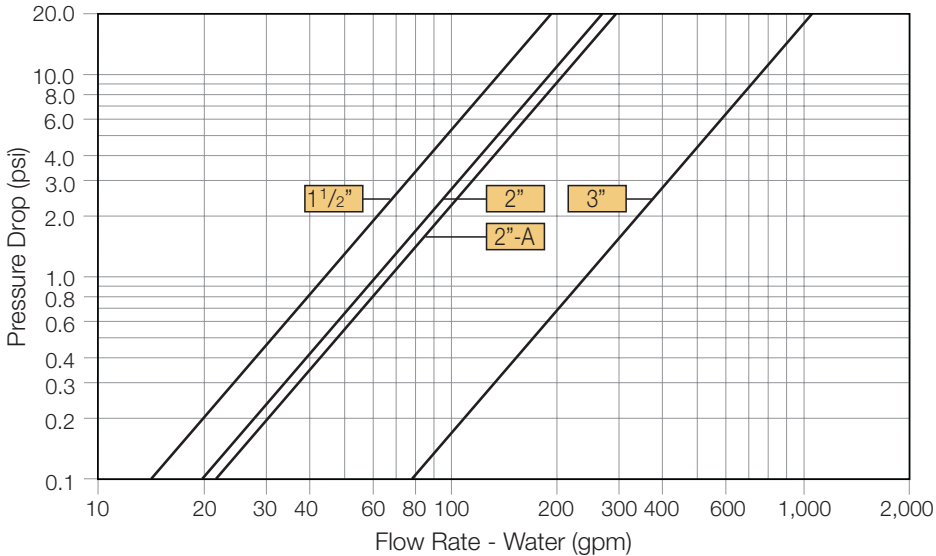

IRIGATION

Irrigation for Agriculture

Engineering Data

IR-ROO Series

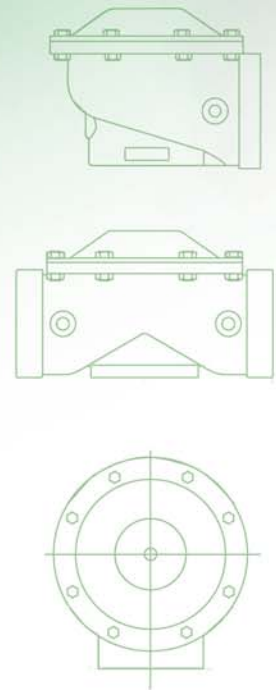
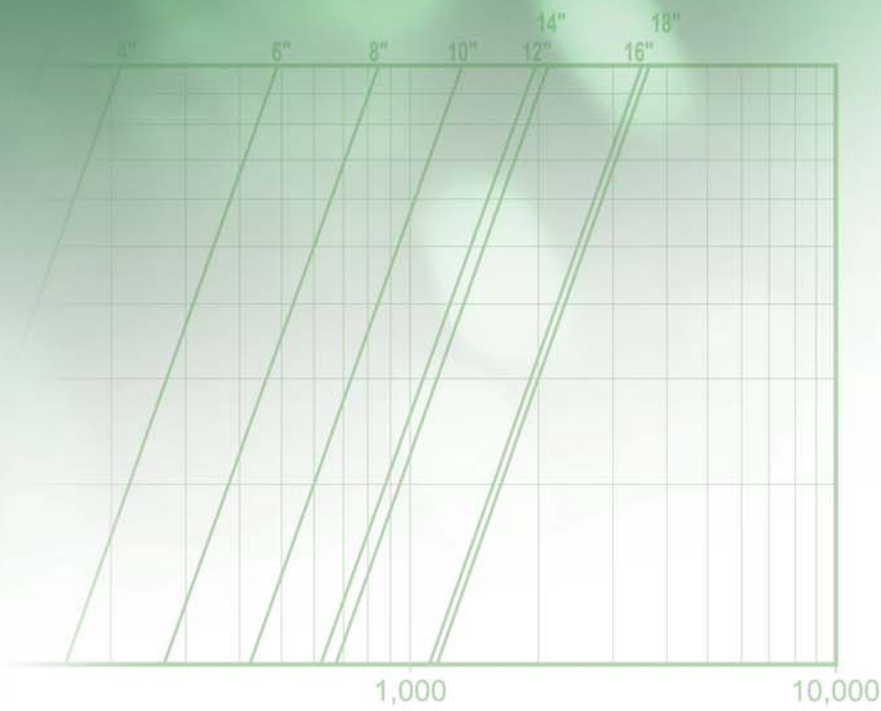

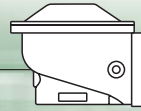

Product Parts Features

[1] Fastening Bolts

Quick in-line inspection and service

[2] Valve Cover

Locates, centralizes and fastens diaphragm and spring ensuring smooth and accurate performance.

[3] Spring Assembly

Three auxiliary closing springs are available

Standard Spring - To open by Line Pressure of 0.9 bar; 13 psi

Light Spring - To open by 0.2 bar; 3 psi (for 2W & 2W/3W Control Circuits)

Strong Spring - To open by 1.9 bar; 28 psi (for Anti-Drain Applications)

[4] Diaphragm

One piece flexible fiber reinforced diaphragm with a rugged seal disk.

The cone-shaped seal disk penetrates the seat as the valve modulates closed, providing:

- Guidance as conditions get rough
- No chattering and slamming closed
- Accurate and stable low flow regulation

[5] Integrated Fastening Threads

No need for nuts, simplifying valve disassembling and assembling

[6] Valve Body

All patterns consist of hydro-dynamic globe design, which provides high flow capabilities with minimum head loss. Full bore raised seat with unobstructed flow path, free of any in-line ribs, supporting cage, or shafts.

[6.1] Dual-Actuator-Tee Valve Body: Two valves in one component. Common inlet with two separately controlled outlets. Saves place, cost and maintenance.

[6.2] Tee Valve Body

[6.3] Angle Valve Body

[7] End Connections

Standard – Female Threads

Option ('T' & 'D' Patterns only) - Horn (quick latch coupling)

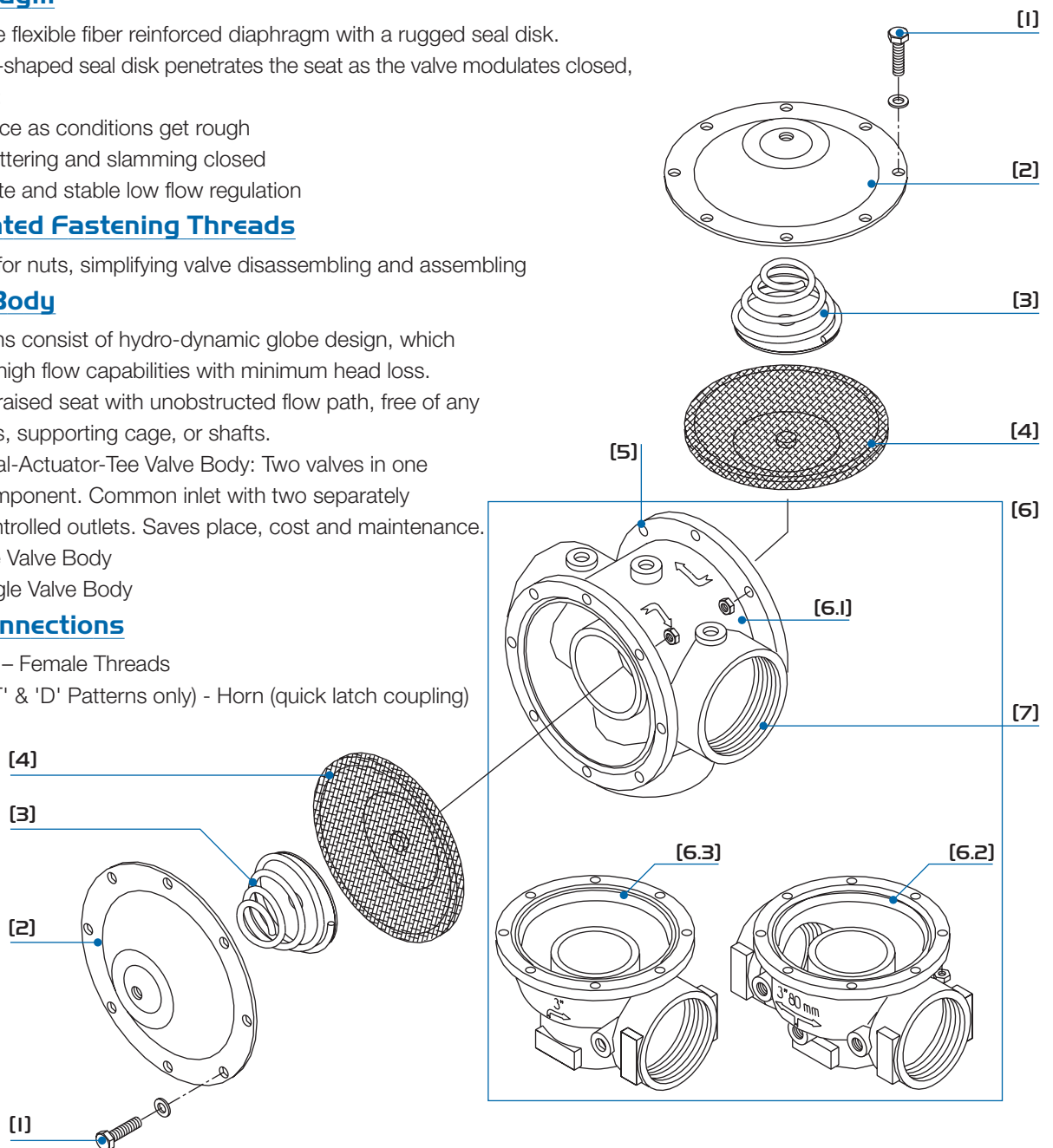

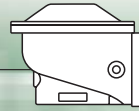

Technical Data



Dimensions & Weights

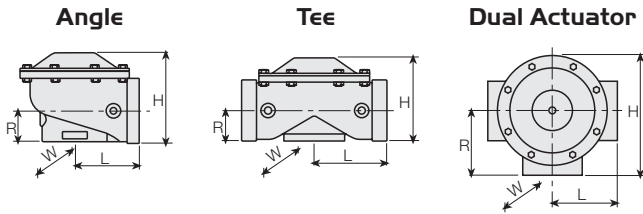

Pattern Size	Angle		Tee		Dual
	Aluminum	Iron	Aluminum	Iron	Aluminum
L* (mm)	107	107	107	107	111
W (mm)	183	183	183	183	200
H (mm)	148	151	148	151	190
R (mm)	50	53	50	53	100
Weight*(kg)	3.0	6.0	3.2	7.2	5.7

* For models with "quick" couplings, add 35 mm to length and approx. 25% to weight.

Technical Specifications

Available Patterns:

Angle, Tee & Dual Actuator Tee

End Connections:

Female threaded

Option ('T' & 'D' Patterns only): Horn (quick latch coupling with rubber ring joint)

Pressure Rating: 10 bar

Operating Pressure Range:

0.9-10 bar, with standard spring

Temperature Range:

Water up to 60°C

Standard Materials:

- Body: Cast iron or Aluminum Alloy super hard Anodized
- Cover: Polyester coated Steel
- Diaphragm: Nylon fabric, reinforced natural Rubber
- Seals: NBR [Buna-N]
- Spring: Stainless Steel 302
- Cover Bolts: Stainless Steel

Flow Charts

The Flow Charts are for Valves with Standard Closing Spring.

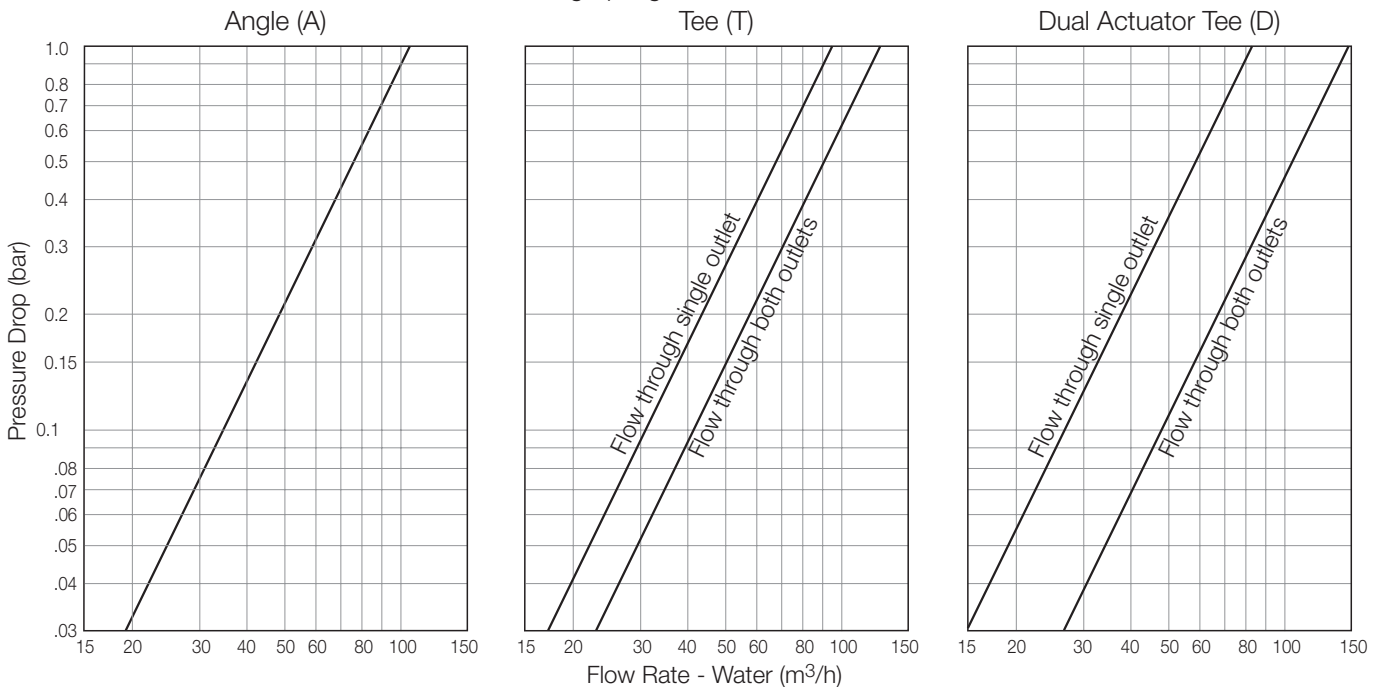

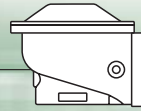

Technical Data



Dimensions & Weights

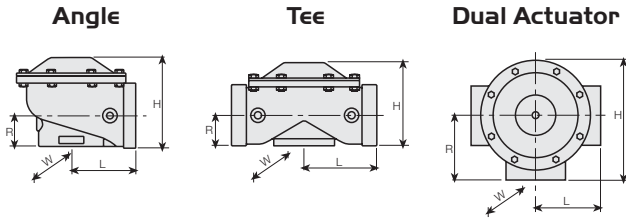

Pattern Size	Angle		Tee		Dual
	Aluminum	Iron	Aluminum	Iron	Aluminum
L* (inch)	47/32	47/32	47/32	47/32	43/8
W (inch)	713/64	713/64	713/64	713/64	77/8
H (inch)	513/16	515/16	513/16	515/16	71/2
R (inch)	2	21/16	2	21/16	315/16
Weight* (lb)	6.6	13.2	7.1	15.9	12.6

* For models with "quick" couplings, add 1³/₈" to length and approx. 25% to weight.

Technical Specifications

available Patterns:

Angle, Tee & Dual Actuator Tee

End Connections:

Female threaded

Option ('T' & 'D' Patterns only): Horn (quick latch coupling with rubber ring joint)

Pressure Rating: 145 psi

Operating Pressure Range:

13-145 psi, with standard spring

Temperature Range:

Water up to 140°F

Standard Materials:

- Body: Cast iron or Aluminum Alloy super hard Anodized
- Cover: Polyester coated Steel
- Diaphragm: Nylon fabric, reinforced natural Rubber
- Seals: NBR [Buna-N]
- Spring: Stainless Steel
- Cover Bolts: Stainless Steel

Flow Charts

The Flow Charts are for Valves with Standard Closing Spring.

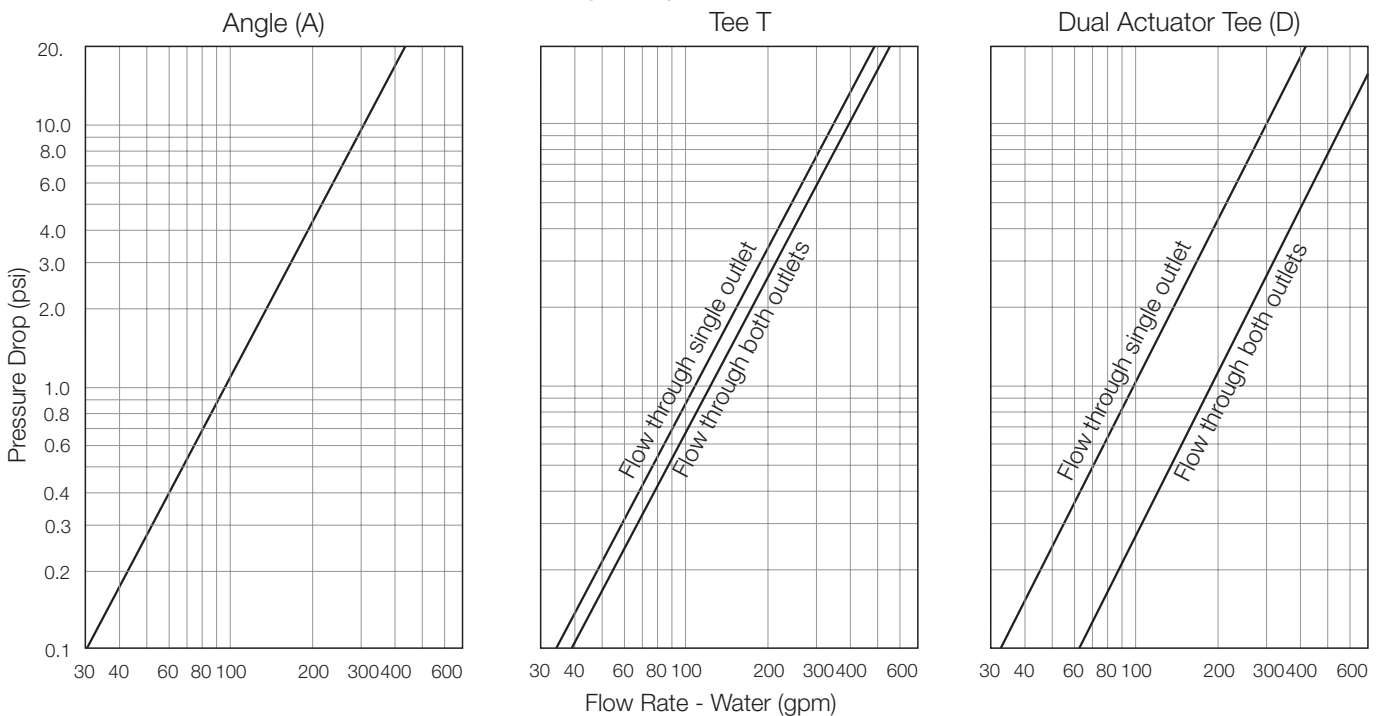

Irrigation

Irrigation for Agriculture

Engineering Data

PRV Series

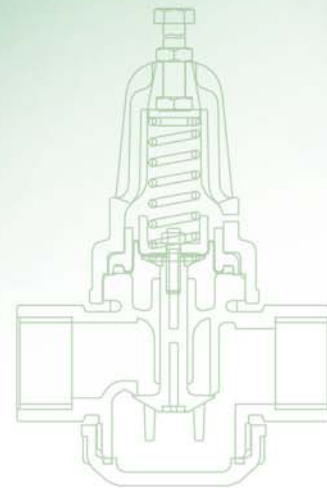
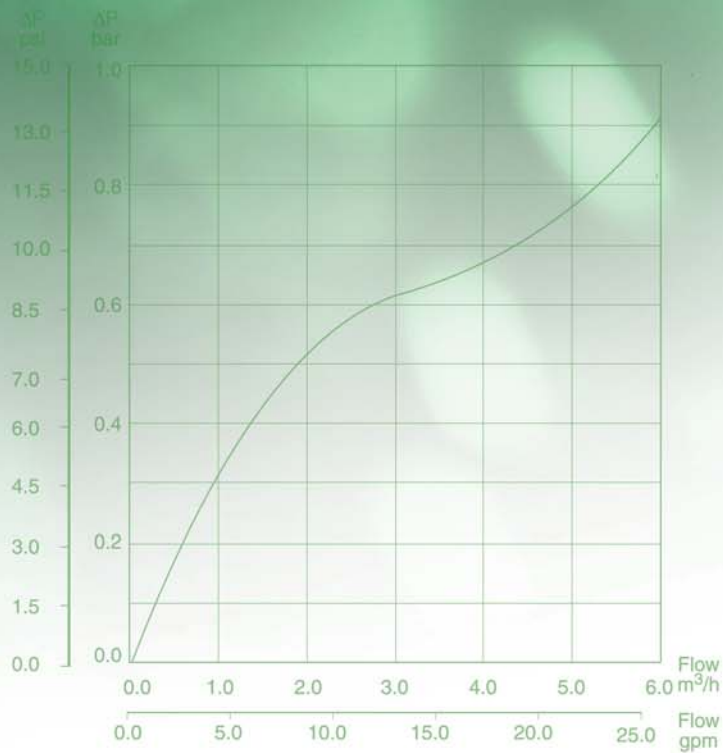

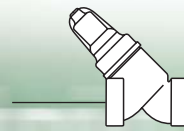

3/4"-PRV & 3/4"-PRV-05

Dimensions

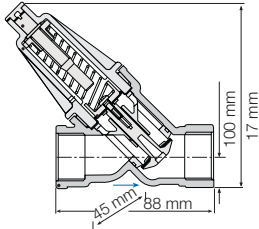

Weight: 0.13 Kg

Technical Data

Size: 3/4"; DN20

End Connections: Threaded

Inlet: Female BSP; NPT

Outlet: Female BSP; NPT or Male BSPT; NPT

Flow Range Model 3/4"-PRV: 0.2-5 m³/h

Flow Range Model 3/4"-PRV-05: 0.01-3 m³/h

Pressure Ratings: 9 bar

Operating Pressure Range: 0.7-9 bar

Setting Springs Selection Table

Setting Range bar	Spring Color	Spring Name
0.5-1.2	Yellow	A
0.8-2.5	White	B
2.0-4.0	Red	C
3.5-6.0	Black	D

Flow Chart

Required supply pressure above setting

ΔP To calculate the minimum required supply pressure, bar add the ΔP in the Flow Chart to PRV desired set point.

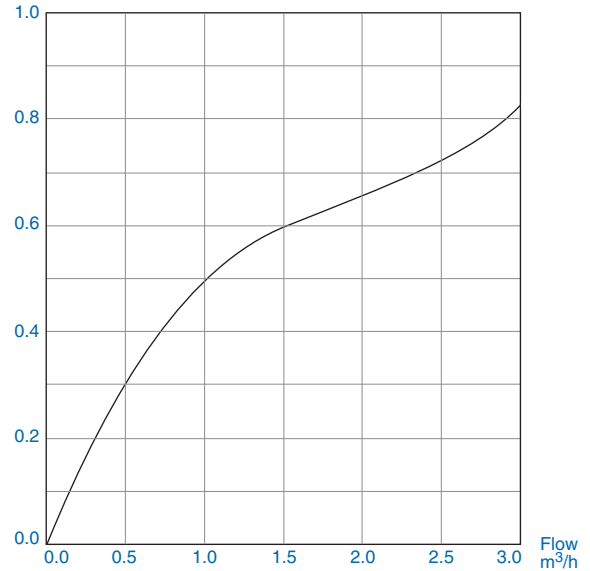

1"-PRV & 1"-PRV-05

Dimensions

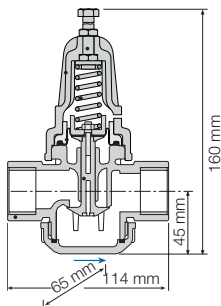

Weight: 0.36 Kg

Technical Data

Size: 1"; DN25

End Connections: Female Threads BSP; NPT

Flow Range Model 1"-PRV: 0.45-7 m³/h

Flow Range Model 1"-PRV-05: 0.1-7 m³/h

Pressure Ratings: 9 bar

Operating Pressure Range: 0.7-9 bar

Setting Springs Selection Table

Setting Range bar	Spring Color	Spring Name
0.5-1.2	White	B
1.0-2.0	Red	C
1.5-3.5	Black	D
3.0-5.5	Brown	Q

Flow Chart

Required supply pressure above setting

ΔP To calculate the minimum required supply pressure, bar add the ΔP in the Flow Chart to PRV desired set point.

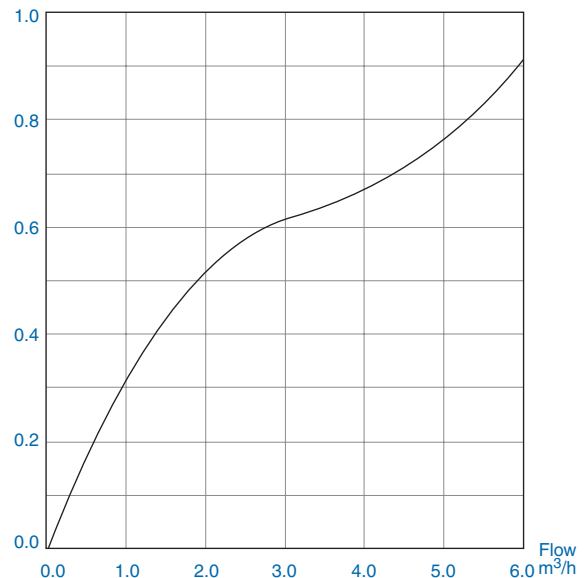

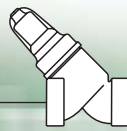

SI Metric

1 1/2"-PRV

Dimensions

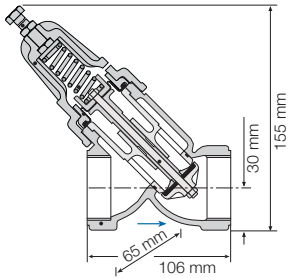

Weight: 1.07 Kg

Technical Data

Size: 1 1/2"; DN40
End Connections: Female Threads BSP; NPT
Flow Range: 0.45-18 m³/h
Pressure Ratings: 9 bar
Operating Pressure Range: 0.7-9 bar

Setting Springs Selection Table

Setting Range bar	Spring Color	Spring Name
0.5-1.2	White	B
1.0-2.0	Red	C
1.5-3.5	Black	D
3.0-5.5	Brown	Q

Flow Chart

Required supply pressure above setting

ΔP To calculate the minimum required supply pressure, add the ΔP in the Flow Chart to PRV desired set point.

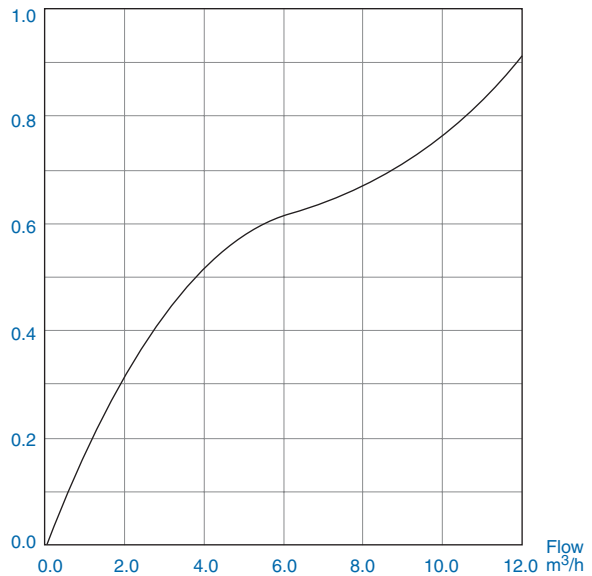

2"-PRV

Dimensions

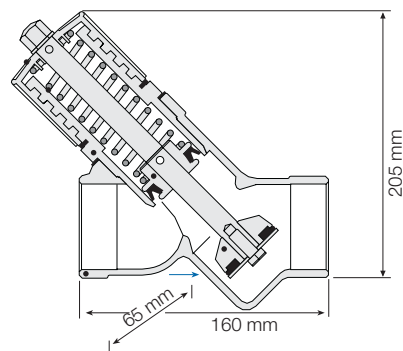

Weight: 2.5 Kg

Technical Data

Size: 2"; DN50
End Connections: Female Threads BSP; NPT
Flow Range: 4-25 m³/h
Pressure Ratings: 8 bar
Operating Pressure Range: 2-8 bar

Setting Springs Selection Table

Spring Color	Downstream Pressure bar		
	Nominal	Minimum	Maximum
Red	2.0	2.0	2.6
Yellow	4.0	3.8	4.6
Green	6.0	5.8	6.6

Flow Chart

Required supply pressure above setting

ΔP To calculate the minimum required supply pressure, add the ΔP in the Flow Chart to PRV desired set point.

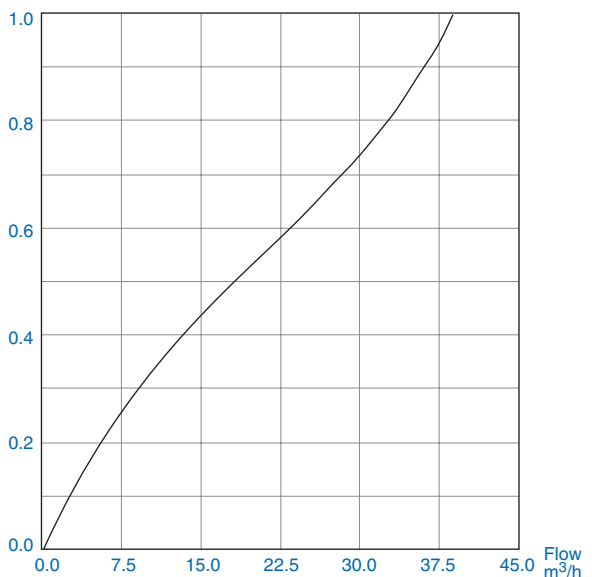

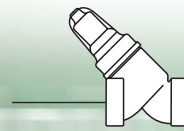

US English

3/4"-PRV & 3/4"-PRV-05

Dimensions

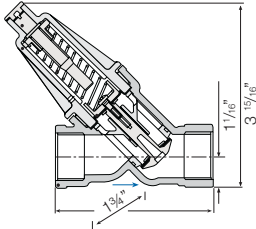

Weight: 0.29 lbs.

Technical Data

Size: 3/4"

End Connections: Threaded

Inlet: Female BSP; NPT

Outlet: Female BSP; NPT or Male BSPT; NPT

Flow Range Model 3/4"-PRV: 0.9-22 gpm

Flow Range Model 3/4"-PRV-05: 0.04-13 gpm

Pressure Ratings: 130 psi

Operating Pressure Range: 10-130 psi

Setting Springs Selection Table

Setting Range psi	Spring Color	Spring Name
7-18	Yellow	A
12-36	White	B
29-58	Red	C
50-87	Black	D

Flow Chart

Required supply pressure above setting

ΔP To calculate the minimum required supply pressure, add the ΔP in the Flow Chart to PRV desired set point.

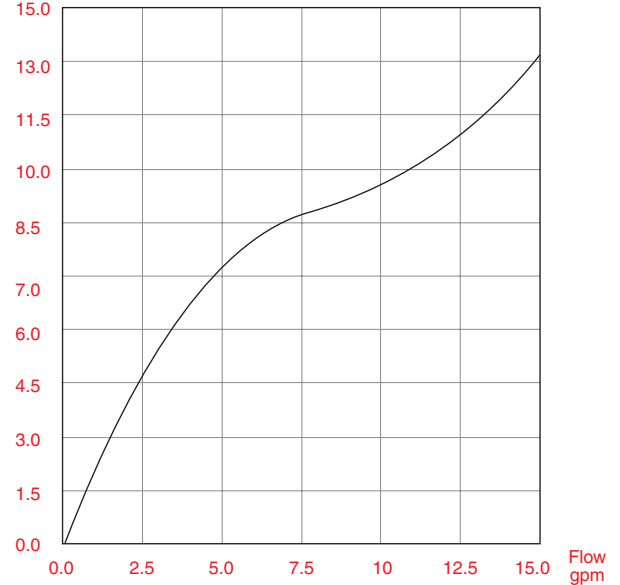

1"-PRV & 1"-PRV-05

Dimensions

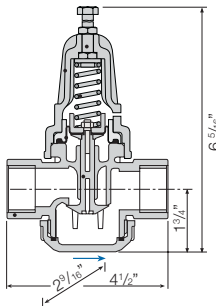

Weight: 0.79 lbs.

Technical Data

Size: 1"

End Connections: Female Threads BSP; NPT

Flow Range Model 1"-PRV: 2-31 gpm

Flow Range Model 1"-PRV-05: 0.4-31 gpm

Pressure Ratings: 130 psi

Operating Pressure Range: 10-130 psi

Setting Springs Selection Table

Setting Range psi	Spring Color	Spring Name
7-18	White	B
14-29	Red	C
22-51	Black	D
44-80	Brown	Q

Flow Chart

Required supply pressure above setting

ΔP To calculate the minimum required supply pressure, add the ΔP in the Flow Chart to PRV desired set point.

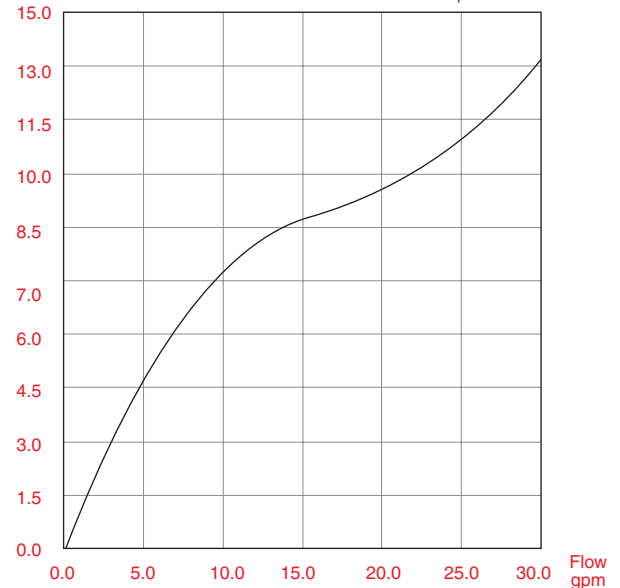

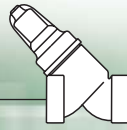

US English

1 1/2"-PRV

Dimensions

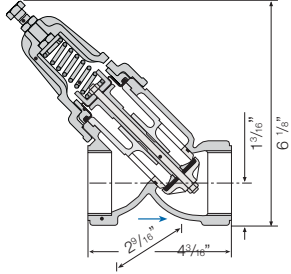

Weight: 2.36 lbs.

Technical Data

Size: 1 1/2"
End Connections: Female Threads BSP; NPT
Flow Range: 2-80 gpm
Pressure Ratings: 130 psi
Operating Pressure Range: 10-130 psi

Setting Springs Selection Table

Setting Range psi	Spring Color	Spring Name
7-18	White	B
14-29	Red	C
22-51	Black	D
44-80	Brown	Q

Flow Chart

Required supply pressure above setting

ΔP To calculate the minimum required supply pressure, add the ΔP in the Flow Chart to PRV desired set point.

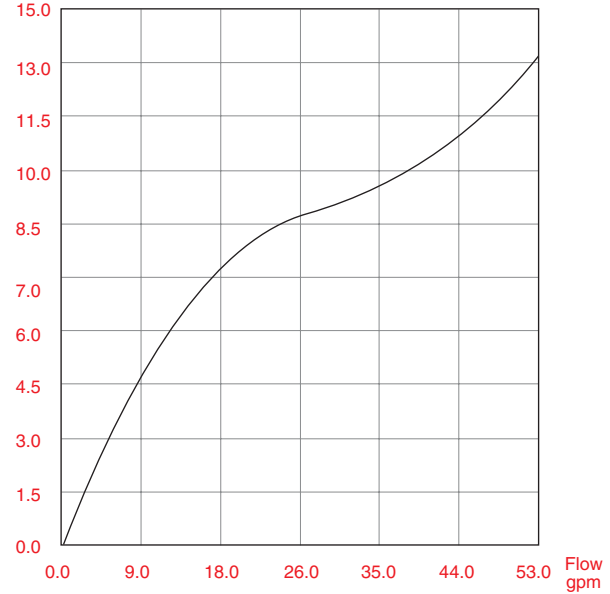

2"-PRV

Dimensions

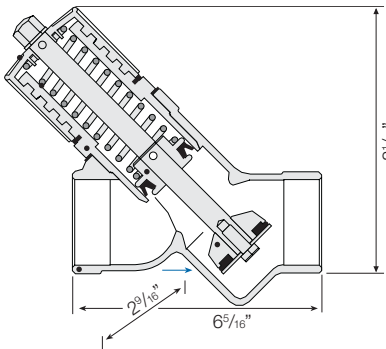

Weight: 5.5 lbs.

Technical Data

Size: 2"
End Connections: Female Threads BSP; NPT
Flow Range: 18-110 gpm
Pressure Ratings: 115 psi
Operating Pressure Range: 30-115 psi

Setting Springs Selection Table

Spring Color	Downstream Pressure psi		
	Nominal	Minimum	Maximum
Red	29	29	38
Yellow	58	55	67
Green	87	84	96

Flow Chart

Required supply pressure above setting

ΔP To calculate the minimum required supply pressure, add the ΔP in the Flow Chart to PRV desired set point.

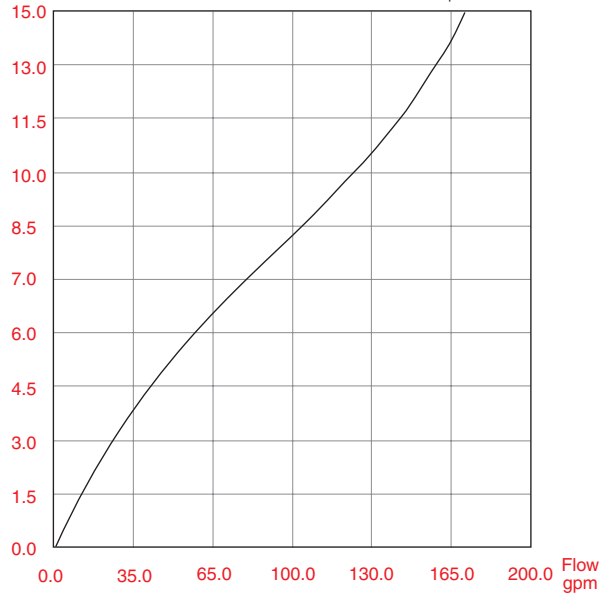

Irrigation for Agriculture

Accessories





Positioning 3-Way Pilot Valve

PC-X-P, Plastic

PC-X-M, Metal

This multi-purpose, direct acting 3-way positioning pilot valve is actuated by a pressure responsive diaphragm, which seeks to reach equilibrium between hydraulic and set spring forces. The pilot directs flow and pressure between its ports:

- When sensed pressure is above set point, it connects port 0 to port 3.
- When sensed pressure is equal to set point, it blocks connections between all ports.
- When sensed pressure is below set point, it connects port 3 with port 2.

Relevant pressure is continuously sensed through port 1.

Setting Range Table

Spring	Pressure	
	bar	psi
G-Blue	1-10	15-145
H-Orange	1-7	15-100
N-Natural	0.8-6.5	11-95
K-Gray	0.5-3	7-40

Connections

- 0 - Upstream for reducing, Vent for sustaining
- 3 - Valve control chamber
- 2 - Vent for reducing, Upstream for sustaining
- 1 - Pressure Sensing



Pressure Reducing Pilot Valve

PC-20-P, Plastic

PC-20-M, Metal

This pilot integrates all principal functions of a 2-way control circuit into a single assembly. It is a direct acting pilot valve, actuated by a pressure responsive diaphragm, which seeks to reach equilibrium between hydraulic and set spring forces. When used in a pressure reducing circuit, the pilot modulates closed as downstream pressure rises above set point. An internal restriction acts as an upstream flow restrictor.

Setting Range Table

Spring	Pressure	
	bar	psi
G-Blue	1-10	15-145
H-Orange	1-7	15-100
N-Natural	0.8-6.5	11-95
K-Gray	0.5-3	7-40

Connections

- 1 or 2 - Downstream / Remote sensing
- 3 - Valve control chamber
- 4 - Upstream



Pressure Sustaining Pilot Valve

PC-30-P, Plastic

PC-30-M, Metal

This is a 2-way direct acting pilot valve, actuated by a pressure responsive diaphragm, which seeks to reach equilibrium between hydraulic and set spring forces. When used in a pressure relief/sustaining circuit, the pilot modulates open as upstream pressure rises above set point.

Setting Range Table

Spring	Pressure	
	bar	psi
G-Blue	1-12	15-175
H-Orange	1-7	15-100
N-Natural	0.8-6.5	11-95

Connections

- 0 - Downstream
- 1 - Sensing/pressure gauge
- 2 - Sensing/Pressure gauge
- 3 - Valve control chamber
- 4 - Upstream (through internal restriction)



Quick Pressure Relief Pilot Valve

PC-3Q-P, Plastic

PC-3Q-M, Metal

This pilot integrates all principal functions of a 2-Way control circuit in a single assembly. It is a direct acting pilots valve, actuated by a pressure responsive diaphragm, which seeks to reach equilibrium between hydraulic and set spring forces. The pilot opens at upstream pressure rise above set point. An integral restriction acts as an upstream flow restrictor smoothing valve closing and simplifying the control circuit.

Setting Range Table

Spring	Pressure	
	bar	psi
G-Blue	1-12	15-175
H-Orange	1-7	15-100

Connections

- 1 - Upstream
- 2 - Plugged
- 3 - Valve control chamber
- 0 - Downstream



Pressure Reducing Servo Pilot Valve

PC-S-P, Plastic

PC-S-M, Metal

This pilot combines all principal functions of a 2-way control circuit with elements of a 3-way control circuit. It is a direct acting pilot valve, actuated by a pressure responsive diaphragm, which seeks to reach equilibrium between hydraulic and set spring forces. A fully balanced trim ensures high accuracy and stability.

Setting Range Table

Spring	Pressure	
	bar	psi
K-Grey	0.5-3	7-40
J-Green	0.2-1.7	3-25

Connections

- 0 - Upstream for reducing
- 1 - Sensing
- 2 - Downstream for reducing
- 3 - Valve control chamber



Paddle Flow Rate Servo Pilot

PC-70-M, Metal

PC-70-P, Plastic

This flow rate pilot combines all principal functions of a 2-way control circuit with elements of a 3-way control circuit. It is a direct acting pilot valve, actuated by a paddle that is positioned within the flow stream. Should demand rise above setting, the dynamic force of the increasing flow moves the paddle, which thereby pushes the pilot trim against the spring force. This causes the main valve to throttle closed, limiting system flow to pilot setting.

Setting Range Table

Spring	Flow Velocity	
	m/s	f/s
E-Purple	1-5	3.3-16.4

Connections

- 1 - Upstream
- 2 - Downstream
- 3 - Valve control chamber

Paddle Length Table

Valve size		Paddle Length (mm)	Paddle Length (inch)	Number Leaves	Valve size		Paddle Length (mm)	Paddle Length (inch)	Number Leaves
inch	DN				inch	DN			
1 1/2	40	35	1 3/8	1	4R	100R	50	2	2
2	50	35	1 3/8	1	4	100	65	2 1/2	3
2 1/2	65	45	1 3/4	2	6	150	80	3 1/8	4
3R	80R	35	1 3/8	1	8	200	95	3 3/4	5
3	80	50	2	2	10	250	110	4 5/16	6



Pressure Reducing Pilot Valves

BERMAD Pressure Reducing Pilot Valves are direct acting pilot valves, actuated by a pressure responsive diaphragm, which tends to reach equilibrium with the set spring force. They continuously sense downstream or other pressure, which serves as an operating parameter, and throttle closed as sensed pressure rises above set point, controlling the main valve accordingly.



Pressure Reducing Pilot Valve

#2PB

Fully balanced trim ensures high accuracy and stability. When used in a pressure reducing circuit, the pilot throttles closed as downstream pressure rises above set point.

Setting Range Table

Spring	Pressure	
	bar	psi
M	1-16	15-230
N	0.8-6.5	11-95
J*	0.2-1.7	3-25

Connections

- Z - Upstream
- A - Valve control chamber
- C - Downstream
- F/D - External sensing/pressure gauge

* For #2PB-D, differential sensing



Pressure Reducing Pilot Valve with integral needle valve

#2

This pilot integrates all principal functions of a 2-way control circuit in a single assembly. An integral needle valve acts as an upstream flow restrictor as well as a closing speed control.

Setting Range Table

Spring	Pressure	
	bar	psi
16	1-16	15-230
10	0.8-10	11-150
16*	2-30	30-430
16*	2-45	30-650

Connections

- Z - Upstream
- A - Valve control chamber
- C - Downstream
- F/D - External sensing/pressure gauge

* With high pressure setting kit



High Sensitivity Pressure Reducing Pilot Valve with integral needle valve

#82

This high sensitivity direct acting pilot specially suits very low set pressures or level control applications. It integrates all principal functions of a 2-way control circuit in a single assembly. An integral needle valve acts as an upstream flow restrictor as well as a closing speed control.

Setting Range Table

Code	Pilot	
	Meter	Feet
M6	2-14	7-46
M5	5-22	17-72
M4	15-35	49-115
M8	25-70	82-230

Connections

- Z - Upstream
- A - Valve control chamber
- C - Downstream

Sensing -

- For altitude control – still point at reservoir bottom
- For pressure reducing – to valve downstream



Pressure Sustaining Pilot Valves

BERMAD Pressure Sustaining Pilot Valves are direct acting pilot valves, actuated by a pressure responsive diaphragm, which tends to reach equilibrium with the set spring force. They continuously sense upstream or other pressure, which serves as an operating parameter, and modulate open as sensed pressure rises above set point, controlling the main valve accordingly.



Pressure Sustaining Pilot Valve

#3PB

When used in a pressure sustaining circuit, the pilot modulates open as upstream pressure rises above set point.

Setting Range Table

Spring	Pressure	
	bar	psi
M	1-16	15-230
N	0.8-6.5	11-95
J*	0.2-1.7	3-25

* For #3PB-D, differential sensing

Connections

- 1 - Remote sensing or pressure gauge
- 2 - Valve control chamber
- 3 - Remote sensing or pressure gauge
- 4 - Downstream

Note: Upstream pressure is connected to valve control chamber via a restriction.



Pressure Sustaining Pilot Valve with integral needle valve

#3

This pilot integrates all principal functions of a 2-way control circuit in a single assembly. An integral needle valve acts as an upstream flow restrictor as well as a closing speed control.

Setting Range Table

Spring	Pressure	
	bar	psi
16	1-16	15-230
10	0.8-10	11-150
16*	2-30	30-430
16*	2-45	30-650

* With high pressure setting kit

Connections

- Z - Upstream
- A - Valve control chamber
- C - Downstream
- F/D - External sensing/pressure gauge



High Sensitivity Pressure Sustaining Pilot Valve with integral needle valve

#83

This high sensitivity direct acting pilot specially suits very low set pressures or level sustaining applications. It integrates all principal functions of a 2-way control circuit in a single assembly. An integral needle valve acts as an upstream flow restrictor as well as a closing speed control.

Setting Range Table

Code	Pilot	
	Meter	Feet
M6	2-14	7-46
M5	5-22	17-72
M4	15-35	49-115
M8	25-70	82-230

Connections

- Z - Upstream
- A - Valve control chamber
- C - Downstream

Sensing -

- For level sustaining - still point at reservoir bottom
- For pressure sustaining - valve upstream



Positioning Pilot Valves

BERMAD multi-purpose, direct acting, 3-way positioning pilot valves are actuated by a pressure responsive diaphragm, which tends to reach equilibrium with the set spring force.

The pilot directs flow and pressure between its ports:

- When sensed pressure is above set point, it connects port C to port O.
- When sensed pressure is equal to set point, it blocks connections between all ports.
- When sensed pressure is below set point, it connects port C with ports A and Z.

An integral needle valve restricts flow through port Z.



Positioning Pilot Valve

#X

Suitable for Pressure Reducing Valves, Pressure Sustaining Valves, and Pressure Reducing & Sustaining Valves, the Positioning Pilot provides accurate and stable regulation, fully opening or closing the valve upon sensed pressure discrepancy from setting.

The pilot can also serve as an Adjustable Hydraulic Relay (N.O. or N.C.) or Automatic Regulation Override (feature 09).

Setting Range Table

Spring	Pressure	
	bar	psi
16	1-16	15-230
10	0.8-10	11-150

Connections

- O** - Upstream for reducing, vent for sustaining
- C** - Valve control chamber
- A/Z** - Vent for reducing, upstream for sustaining
- F/D** - Sensing/pressure gauge



Altitude Pilots and Level control Float Valves

Altitude pilots and Level control float Valves enable external installation of the main valve, eliminating installation and maintenance problems associated with mechanical float valves installed in the reservoir. A wide selection of altitude and float pilots makes BERMAD Float Control Valves the right solution wherever level control is required.



Altitude (High Sensitivity) Positioning Pilot Valve

#8

This Altitude (High Sensitivity) Positioning Pilot senses reservoir level and controls the valve to shut at the preset reservoir high level, and to fully open in response to an approximately one-meter (three-foot) level drop. The pilot is also suitable for Pressure Reducing Valves with very low setting requirements.

Setting Range Table

Code	Pilot	
	Meter	Feet
M6	2-14	7-46
M5	5-22	17-72
M4	15-35	49-115
M8	25-70	82-230

Connections

0 - Upstream

C - Valve control chamber

A - Vent (Z plugged)

Z - Vent through needle valve (A plugged)

Sensing - Still point at reservoir bottom



4-Way Bi-Level Vertical Float

Float #66

This 4-Way, adjustable, last position Bi-Level Vertical Float, is actuated by the float's sliding along the rod assembly either pulling it down or pushing it up, switching the float pilot position. When the float is between the adjustable high and low level stoppers, the main valve remains in its last position. The float pilot directs flow and pressure between its ports:

- When the float pushes the upper stopper up, it connects port P to C1 and port C2 to V.
- When the float pulls the lower stopper down, it connects port P to C2 and port C1 to V.

The extendable rod is to be balanced by counterweights installed on the lever system according to rod length and system pressure.

Notes:

- Minimum level differential: 15 cm (6")
- Maximum level differential: 54 cm (21")
- Each extension rod adds 56 cm (22"), one extension rod supplied
- Extra counterweight required if second extension rod used
- Float hydraulic connections: 3 tubes size 3/8"

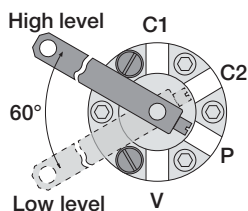

Connections

Port	Reservoir inlet	Reservoir outlet
C1	Upper control chamber	Lower control chamber
C2*	Lower control chamber (or plugged)	Upper control chamber
P	Upstream pressure	Upstream pressure
V	Vent	Vent

* For double chambered valve only, plugged in single chamber applications



Solenoid Selection Guide

The automation design is an integral part of the irrigation project design file. In order to help in the selection process of the most suitable solenoids for a given project, several questions need to be answered. Following the chart below, will guide you to the desired solenoid model. Please check selected solenoid specifications in the following pages, to confirm its suitability to the project conditions.

Please refer to the following questions for best navigation:

- **Operating Current:** Alternating Current (AC) or Direct Current (DC)
- **Solenoid Logic:** 2-Way or 3-Way
- **Actuator Type:** Continuous Current or Latching
- **Solenoid Normal Position:** Normally Open or Normally Closed
- **Controller Requirements:** Two Wires or Three Wires

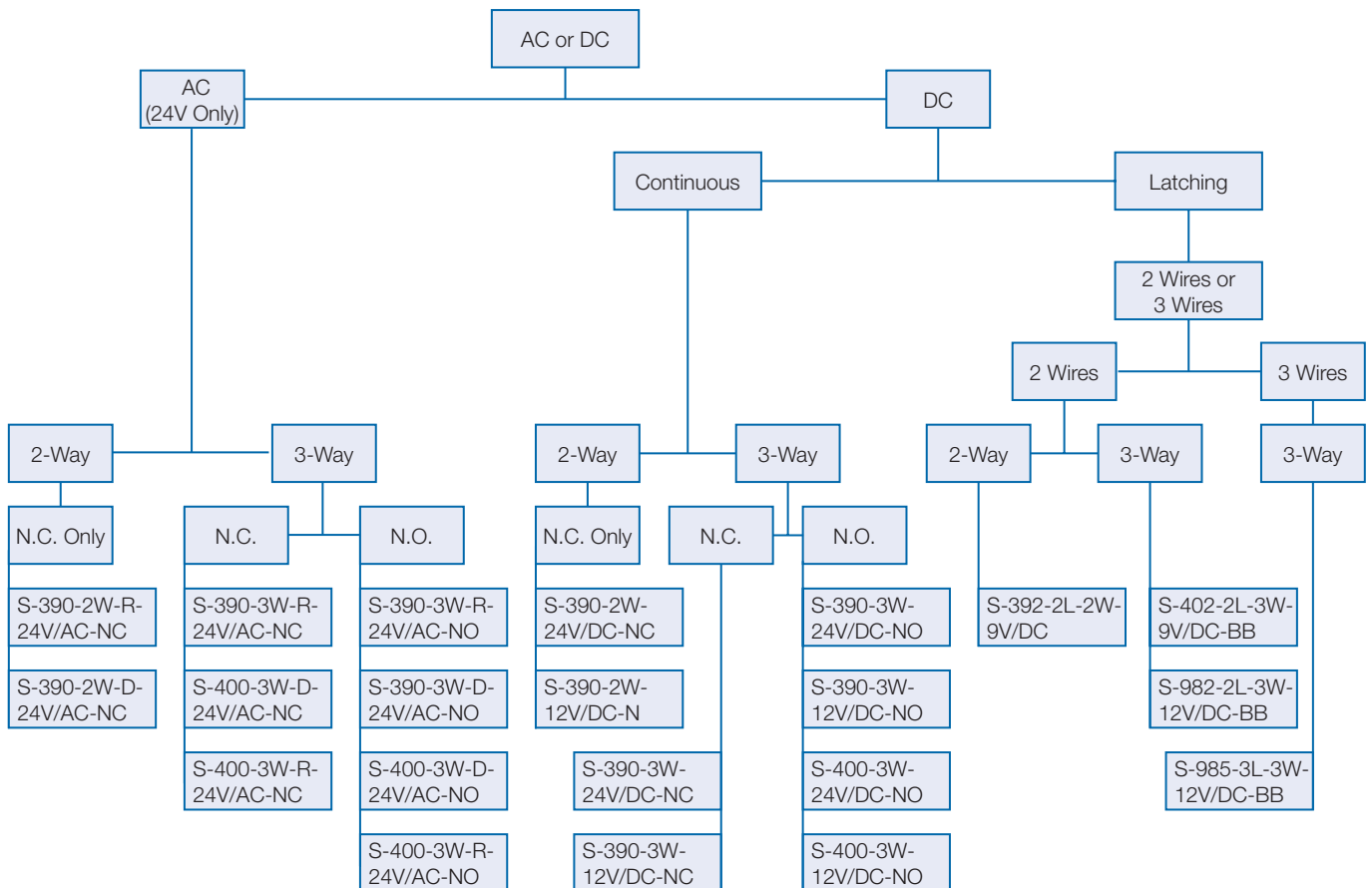

Notes:

- To get a 3-way controlled N.C. main valve, use a N.O. 3-way solenoid and vice versa.
- S-400 models include bigger orifice diameter than S-390, which means quicker action.
- The S-982 and S-985 actuators are isolated from the water.
- Actuators with the suffix 'R' are suitable to areas with high lightning's probability
- Calculate wires cross section in accordance to:
 - System pressure conditions
 - Solenoids consumption, quantity & distance



Solenoids

BERMAD Continuous Current Solenoids are specially designed for reliable long life service in irrigation systems. They excel in their low power consumption and low sensitivity to dirt and voltage variations and are compliant with all Continuous Current Controllers on the market.



2-Way Solenoid Actuator

S-390-2W

The BERMAD S-390-2W is a compact 2-Way, Normally Closed, Solenoid Actuator. It is applicable directly to the valve cover or with a 2-way base that enables combining the S-390-2W in a variety of 2-way control circuits.

Electrical Data

Actuator Type	Cable Color	Power (Watt)	Current (Amp)		Coil Resistance ohm@20°C; 68°F
			Inrush	Hold	
S390-2W-24VAC-R	Red/Red	1.7	0.25	0.125	37.5
S390-2W-24VAC-D	Red/Orange	2.2	0.13	0.13	*
S390-2W-24VDC	Black/Black	3.6	0.18	0.18	156
S390-2W-12VDC	Blue/Blue	4.0	0.33	0.33	36

* Coil resistance in this coil can not be measured



3-Way Solenoid

S-390-3W

The BERMAD S-390-3W is a compact 3-Way Solenoid. It can control valves independently or in combination with other control circuit accessories. The hydraulic base features a manual override and consists of a bracket for attaching to the valve or to a solenoid manifold.

Electrical Data

Actuator Type	Cable Color	Power (Watt)	Current (Amp)		Coil Resistance ohm@20°C; 68°F
			Inrush	Hold	
S-390-3W-24VAC-D NO	Red/Orange	2.2	0.13	0.13	37.5
S-390-3W-24VAC-D NC	Orange/Blue	3.5	0.20	0.20	*
S-390-3W-24VAC-R NO	Red/Red	2.9	0.46	0.24	21
S-390-3W-24VDC NO & NC	Black/Black	4.2	0.17	0.17	135
S-390-3W-12VDC NO & NC	Blue/Blue	4.0	0.33	0.33	36

* Coil resistance in this coil can not be measured

Connections:

- N.O.:** Actuator Port - Pressure
 1- Vent
 2- Valve Control Chamber
N.C.: Actuator Port - Vent
 1- Pressure
 2- Valve Control Chamber



3-Way Solenoid with Hydraulic Base

S-400-3W

The BERMAD S-400-D-3W-BB is a compact 3-Way Solenoid Pilot Valve that can control valves independently or in combination with other control circuit accessories. The hydraulic base features a manual override and consists of a bracket for attaching to the valve or to a solenoid manifold.

Electrical Data

Actuator Type	Cable Color	Power (Watt)	Current (Amp)		Coil Resistance ohm@20°C; 68°F
			Inrush	Hold	
S400-24VAC-D-NO	Red/Blue	3.5	0.20	0.20	*
S400-24VAC-D-NC	Red/Blue	3.5	0.20	0.20	*
S400-24VDC-NO	Black/Black	4.2	0.17	0.17	135
S400-12VDC-NO	Blue/Blue	4.0	0.33	0.33	36

* Coil resistance in this coil can not be measured

Connections:

- N.O.:** 1- Vent
 2- Valve Control Chamber
 3- Pressure
N.C.: 1- Pressure
 2- Valve Control Chamber
 3- Vent



3-Way Solenoid Valve, Direct Acting with Isolating Membrane

Burkert 330

This direct acting 3-Way Solenoid Valve is actuated by a pivoted armature. Its design includes a membrane that hermetically isolates the solenoid actuator from the fluid, making it less sensitive to abrasive or contaminated fluid than a plunger actuated solenoid. This solenoid valve provides best performance with maximum reliability and a long service life, even in seawater applications. The epoxy encapsulation efficiently dissipates heat, to suit continuous duty applications. The Burkert Model 330 can also be used as a 2-Way Solenoid.

Electrical data:

Power consumption:

(ac): 30 VA, inrush; 15 VA (8W), holding
(dc): 8W

Circuit functions

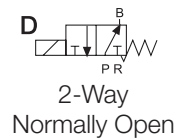
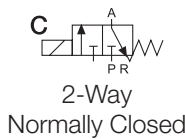
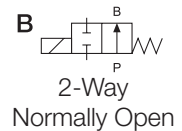
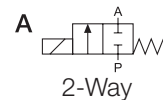

3-Way Solenoid Valve, Direct Acting - Plunger Actuated

Burkert 6014

This direct acting, compact 3-Way Solenoid Valve is plunger actuated. It does not require a minimum operating pressure and is not affected by the mounting position. Its structure ensures long life and durability. The epoxy encapsulation efficiently dissipates heat, to suit continuous duty applications. The Burkert Model 6014 can also be used as a 2-Way Solenoid.

Electrical data:

Power consumption:

(ac): 24 VA, inrush; 17 VA (8W), holding
(dc): 8W

Circuit functions

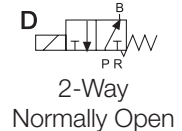
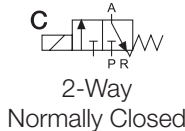

2-Way Solenoid Valve, Servo-Assisted Diaphragm Actuated

Burkert 281

This is a diaphragm actuated, servo-assisted, pilot operated 2-Way Solenoid Valve. It is available in two versions:

- Normally Closed (Model: 5281A)
- Normally Open (Model: 0281B)

Electrical data:

Power consumption:

(ac): 21 VA, inrush; 12 VA (8W), holding
(dc): 8W

Circuit functions

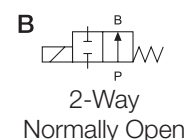
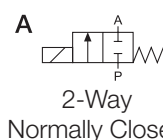



Latching Solenoids

BERMAD Latching Solenoids are specially designed for reliable long life service in irrigation systems controlled by Battery Operated Controllers. The Latching Solenoids consume power only when switching positions, using a very short electric impulse. This prolongs life of batteries and enables solar recharging.



Magnetic Latch Solenoid Actuator, 2-Way, 9VDC Latch, 2- Leads

S-392-2W

The BERMAD Model S-392-2W is a compact 2-Way Latching Solenoid Actuator. It is applicable directly to the valve cover or with a 2-way base that enables combining it in variety of 2-way control circuits.

Electrical Data:

Voltage Range: 6-20 VDC

Coil Resistance: 6Ω

Coil Inductance: 90 mH

Pulse Width: 20-100 mSec.

Required Capacitor: 4700μF

Operation Modes (electrical connections):

+Red & -Black: Latch Position

+Black & -Red: Released Position



Magnetic Latch Solenoid with Hydraulic Base 3-Way, 9VDC Latch, 2- Leads

S-402-3W

The BERMAD Model S-402-3W can control valves independently or in combination with other control circuit accessories. The hydraulic base features a manual override and consists of a bracket for attaching to the valve or to a solenoid manifold.

Electrical Data:

Voltage Range: 9-40 VDC

Coil Resistance: 6Ω

Coil Inductance: 90 mH

Pulse Width: 20-100 mSec

Required Capacitor: 4700μF

Operation Modes (electrical connections):

+Red & -Black: Solenoid vents

+Black & - Red: Solenoid pressurizes

Pressure & Flow Data:

Operating Pressure Range: 0-10 bar

Base Orifice Diameter: 2.2 mm

Base Flow Factor: Kv = 0.12 m³/h @ 1 bar ΔP; Cv = 0.14 GPM @1 psi ΔP

Connections:

1- Vent

2- Valve Control Chamber

3- Pressure

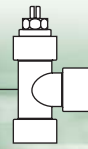

Dry Magnetic Latch Solenoid with Isolating Membrane & Hydraulic Base 3-Way, 12VDC Latch, 2- Leads

S-982-3W

The BERMAD Model S-982-3W actuator is neutralized from water damage by a membrane, which hermetically isolates it from the water. It can control valves independently or in combination with other control circuit accessories. The hydraulic base features a manual override and consists of a bracket for attaching to the valve or to a solenoid manifold.

Electrical Data:

Voltage Range: 12-50 VDC

Coil Resistance: 4.2Ω

Pulse Width: 20-100 mSec.

Required Capacitor: 4700μF

Operation Modes (electrical connections):

+ Red & - Black: Solenoid vents

+ Black & - Red: Solenoid pressurizes

Connections:

1- Vent 2- Valve Control Chamber 3- Pressure

Pressure & Flow Data:

Operating Pressure Range: 0-10 bar

Base Orifice Diameter: 2.2 mm

Base Flow Factor:

Pressure port Kv = 0.12 m³/h @ 1 bar ΔP

Cv = 0.14 GPM @1 psi ΔP

Exhaust port Kv = 0.14 m³/h @ 1 bar ΔP

Cv = 0.16 GPM @1 psi ΔP



Dry Magnetic Latch Solenoid with Isolating Membrane & Hydraulic Base 3-Way, 12VDC Latch, 3- Leads

S-985-3W

The BERMAD Model S-985-3W actuator is neutralized from water damage by a membrane, which hermetically isolates it from the water. It can control valves independently or in combination with other control circuit accessories. The hydraulic base features a manual override and consists of a bracket for attaching to the valve or to a solenoid manifold.

Electrical Data:

Voltage Range: 12-50 VDC

Coil Resistance: 2 Coils - 4.2Ω On; 7.5Ω Off

Pulse Width: 20-100 mSec.

Required Capacitor: 4700μF

Operation Modes (electrical connections):

+ White: Fixed Common

- Red: Solenoid vents

- Black: Solenoid pressurizes

Connections:

1- Vent 2- Valve Control Chamber 3- Pressure

Pressure & Flow Data:

Operating Pressure Range: 0-10 bar

Base Orifice Diameter: 2.2 mm

Base Flow Factor:

Pressure port Kv = 0.12 m³/h @ 1 bar ΔP

Cv = 0.14 GPM @1 psi ΔP

Exhaust port Kv = 0.14 m³/h @ 1 bar ΔP

Cv = 0.16 GPM @1 psi ΔP



Solenoid Valve for Remote Terminal Unit (RTU)

BERMAD's Solenoid Valve for Remote Terminal Unit (RTU) is a solenoid pilot valve controller used in remote control irrigation via radio or cable. It is a battery operated, self-contained unit, suitable for use in irrigation applications with a master radio control system.

Note: RTU units can be purchased only through Motorola® irrigation control department.

For further details please contact: IRRI@motorola.com

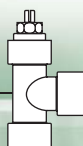

Hydraulic Relay Valve (HRV)

50-P, Plastic

50-M, Metal

This 2-way, single chamber, Hydraulic Relay Valve is a hydraulically operated, diaphragm actuated control valve that shuts off in response to pressure applied to its control chamber, or opens fully upon venting of that pressure.

Technical Data

Pressure rating: Metal - 25bar; 350 psi
Plastic - 10 bar; 145 psi

Flow factor: Metal - Kv=1.3; Cv=1.5

Connections

Metal - 2- Inlet; 1- Outlet
Plastic - 1- Inlet; 2- Outlet



Shuttle Valve

50-X-P, Plastic

50-X-M, Metal

These pressure selector Shuttle Valves have been designed to automatically direct the higher of two pressure sources into a control or sensing chamber. Each source is connected to its own port. The higher pressure creates a superior force that moves the inner plug to seal the counter port, allowing water from the higher pressure source to flow through the common port.

Technical Data

Pressure rating: Metal - 25bar; 350 psi
Plastic - 10 bar; 145 psi

3-Way Hydraulic Relay Valve (3W-HRV)

54-PZ, Galit

54-M - Metal

The 3-Way, single chamber, Hydraulic Relay is a hydraulically operated, diaphragm actuated pilot valve that in response to pressure applied to its control chamber, directs flow and pressure between its ports. It can be used either to relay and accelerate a signal (N.O.), or to reverse and accelerate a signal (N.C.). The Model 54-PZ, Galit also features Manual Override.



Connections

Port	54-M, N.O.*	54-M, N.C.**
1	Upstream pressure	Vent
2	Control chamber	Control chamber
0	Vent	Upstream pressure
U	Command	Command

* With top spring - special order.

** With bottom spring - standard.

Technical Data

Pressure rating: 25 bar; 350 psi
Min. operating pressure: 0.8 bar; 12 psi

Flow factor:

Closing: 0 to 2 & 1 to 2: Kv=1.2; Cv=1.4
Opening: 2 to 1 & 2 to 0: Kv=1.0; Cv=1.2

Connections

Port	54-PZ, N.C.	54-PZ, N.C
1	Command	Command
2	Vent	Upstream pressure
3	Upstream pressure	Vent
4	Control chamber	Control chamber

Technical Data

Pressure rating: 10 bar; 145 psi
Minimum operating pressure: 0.5 bar; 7 psi
Orifice: 5.8 mm; 1/4"
Ports: 1/8" BSP Female Thread

Anti-Topographic Springs

Spring Color	54-PZ, N.C.	54-PZ, N.C.
Yellow	5-10 m	5-10 m
Green	10-14 m	10-15 m
White	14-17 m	5-20 m
Red	17-22 m	20-25 m

Data refers to elevation differential along the control tube



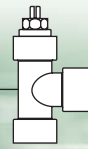

AMV Shut-Off Pilot

3W-SOP

This 3-Way Shut-Off Pilot Valve is a spring-return, flap actuated pilot valve that in response to pushing a spool against a spring, directs pressure and flow between its ports:

- In Set Position the 3W-SOP spool is pushed closed, thereby hydraulically connecting ports C and V.
- In Normal Position the 3W SOP spool is returned by the spring action, hydraulically connecting ports P and C.

By manually turning the AMV setting knob, the flap is actuated to push the spool. After delivering the preset quantity of water, the flap slips into a groove in the turning control head mechanism, allowing the spool to return to Normal Position.

Connections:

- P - Upstream
- C - AMV Control Chamber
- V - Vent



AMV Sequential Shut-Off Pilot

5W-SOP

This 5-Way Shut-Off Pilot Valve directs pressure and flow between its ports:

- In Set Position the 5W-SOP spool is pushed closed, thereby hydraulically connecting ports P to C2 and C1 to V1.
- In Normal Position the 5W-SOP spool is returned by the spring action, hydraulically connecting ports P to C1 and C2 to V2.

Connections:

- P - Upstream
- C₁ - AMV Control Chamber
- C₂ - Next AMV (Plugged for last AMV)
- V₁ - Previous AMV (Vent for first AMV)
- V₂ - Vent



AMV Shut-Off Pilot with Pump Shut-Off Electrical Switch

3W-SOP-S

This 3-Way Shut-off Pilot Valve directs pressure and flow between its ports:

- In Set Position the 3W-SOP-S spool is pushed closed, thereby hydraulically connecting ports C1 to V1.
- In Normal Position the 3W-SOP-S spool is returned by the spring action, hydraulically connecting port P to C1.

The spool activates the electric Change-Over Switch, which turns off the system's pump after delivery of the preset quantity of water.

Connections:

- P - Upstream
- C₁ - AMV Control Chamber
- V₁ -Vent
- C₂ -Plugged

Switch Data:

- Change Over 5-250V
- Electrical Connections N.O. or N.C.



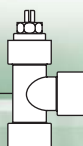

Needle Valve

This adjustable restriction Needle Valve is used for controlling opening or closing speed on various control loops.

Needle valve types:

- 5° - for up to 4"; DN100 valves
- 15° - for 6"; DN150 and larger valves

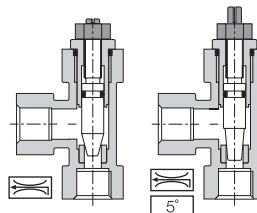

One-Way Flow Control

This device combines an adjustable restriction needle valve one way, and free flow the opposite way. It is used for controlling opening or closing speeds and stabilizing main valve operation.

Technical Data

- Pressure rating:** 40 bar; 600 psi
- Flow factor:** Kv=0.85; Cv=1.0
(in unrestricted flow direction)

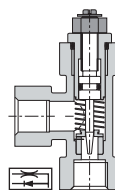

In-Line Filter

These self-flushing In-Line Filters are used for filtration of control fluid of medium and potable water quality. The flowing fluid continuously flushes the filter element.

Technical Data

- Filter element:** 400 micron; 40 mesh
- Threads:** Metal - 1/4", 3/8" & 1/2" NPT; Plastic - 1/4" NPT Male X 1/8" NPT Female



"Y" Strainer

The "Y" Strainer is used for filtration of control fluid with standard potable water quality and standard maintenance.

Technical Data

- Filter element:** 500 micron; 35 mesh
- Ports:** 1/4", 3/8" & 1/2" NPT, 1" BSP



Large Control Filter

The Large Control Filter is used for filtration of dirty control fluid that would quickly block a normal filter element. This larger filter increases both the reliability of the control valve system and the time required between maintenance, while minimizing faulty operation.

Technical Data

- Filter element:** Disks 250 micron; 60 mesh
- Ports:** 3/8" NPT

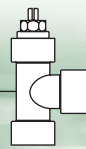

2-Way Ball Valve

This Ball Valve provides quick and easy on/off manual control for isolating, manual release, and draining.

Technical Data

Pressure rating:

40 bar; 600 psi - 1/4" to 3/4"

35 bar; 500 psi - 1" to 2"

Ports:

1/4", 3/8" & 1/2" NPT

3/4", 1", 1 1/2" & 2" BSP



3-Way Ball Valve

This 3-Way Ball Valve is used as a pilot providing quick and easy, 2-position on/off manual control.

Technical Data

Pressure rating: 27.5 bar; 400 psi

Ports: 1/4", 3/8" & 1/2" NPT



Manometer Ball Valve

This vented 2-Way Ball Valve provides quick and easy manual isolating and venting of either pressure gauges or any other pressurized control loop components.

Technical Data

Pressure rating: 16 bar; 230 psi

Ports: 1/8", 1/4" & 3/8" NPT



Check Valve

These spring loaded, non-return valves provide free flow in one direction and prevent flow in the opposite direction. They can be installed in any orientation.

Technical Data

Pressure rating: 20.5 bar; 300 psi

Ports:

1/4", 3/8" & 1/2" NPT

3/4", 1" & 1 1/2" BSP



Orifice Plate Assembly

When an Orifice Plate Assembly is used as an integral part of a flow control valve control circuit, it provides the differential pressure (P) to power the flow control pilot. The opening and closing of the pilot causes the flow control valve to throttle accordingly. Total head loss across the valve is reduced by locating sensing ports close to the orifice plate, to sense downstream pressure before it recovers. The orifice plate's internal diameter is calculated and machined according to valve size and required flow limitation.

Dimensions

Size		Z		X		d		D	
mm	inch	mm	inch	mm	inch	mm	inch	mm	inch
50	2	94	3 11/16	53	2 1/16	20	3/4	25	1
65	2 1/2	106	4 3/16	61	2 3/8	20	3/4	25	1
80	3	126	4 15/16	73	2 7/8	20	3/4	25	1
100	4	155	6 1/8	96	3 3/4	20	3/4	25	1
150	6	210	8 1/4	150	5 15/16	20	3/4	25	1
200	8	265	10 3/8	195	7 11/16	20	3/4	25	1
250	10	320	12 5/8	245	9 5/8	20	3/4	25	1
300	12	372	14 5/8	295	11 5/8	20	3/4	25	1
350	14	418	16 7/16	345	13 5/8	24	15/16	30	1 3/16
400	16	482	19	395	15 9/16	20	3/4	25	1
450	18	535	21 1/16	443	17 7/16	20	3/4	28	1 1/8
500	20	590	23 1/4	501	19 3/4	22	7/8	31	1 3/16

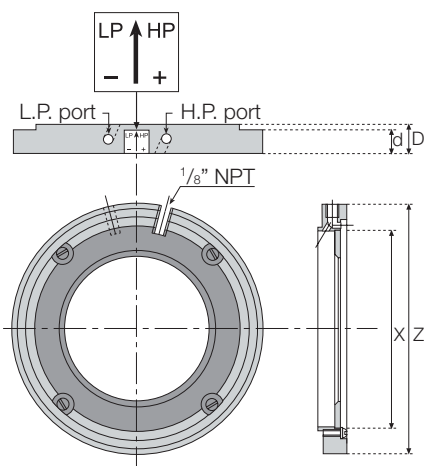

Orifice Assembly

When an Orifice Assembly is used as an integral part of a flow control valve control circuit, it provides a Pressure Differential (P) in direct proportion to the flow rate. This P is sensed by the flow control pilot, powering it to open or close. The opening and closing of the pilot causes the flow control valve to throttle accordingly. The orifice's internal diameter is calculated and machined according to valve size and required flow limitation.

Dimensions

Dimensions	Size	DN50	2"	DN80	2"
D		95 mm	3 3/4"	91 mm	3 9/16"
LB		60 mm	2 3/8"	70 mm	2 3/4"
LT		19 mm	3/4"	30 mm	1 3/16"
P		5 mm	3/16"	5 mm	3/16"
R		44.9mm	1 3/4"	84mm	3 5/16"
TF		G2	2" BSP-F	R3	3" BSP-F
TM		R2	2" BSP-T	R3	3" BSP-T
TP		1/4" NPT			

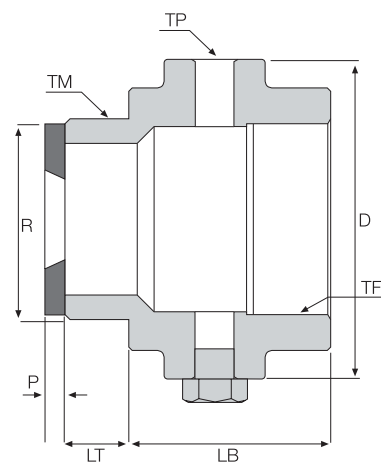

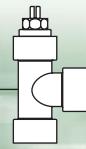

Pressure Gauge

This robust, liquid filled Pressure Gauge is used for heavy duty service where vibration or pulsation of the pressure is liable to cause excessive wear of a dry gauge, or where corrosive ambient conditions or fluid prevail.

Technical Data

Dial size: 2 1/2"; 63 mm

Connection: 1/4" NPT, back or bottom

Scales:

0-6, 10, 16, 25 and 40 bar

0-90, 140, 230, 350 and 600 psi

Accuracy: ± 1.6% of full scale dial



Pressure Sensing Separation Diaphragm

Model 35d

This device is used to isolate and protect the pressure sensing chambers of pilots (and pressure gauges) from highly corrosive fluids, high viscosity fluids, or fluids with suspended solids. It has two chambers separated by a diaphragm. The sensed system pressure is introduced into one chamber, applying force to the diaphragm that transmits it to the second chamber. The second chamber and the pilot sensing chamber are connected and are both filled with a non-aggressive, stable fluid.

Technical Data

Pressure rating: 25 bar; 350 psi

Ports: 1/4" NPT

Air venting ports: 1/8" NPT



Strainer

Model 70F

The BERMAD 70F Strainer is designed to remove foreign matter such as stones, sticks, etc. from the pipeline. It is recommended to install the Strainer upstream from control valves, flow meters and other system appliances. High Pressure Strainer Model 80F is also available. close to the orifice plate, to sense downstream pressure before it recovers. The orifice plate's internal diameter is calculated and machined according to valve size and required flow limitation.

Dimensions & Weight

Size	L		H		W		B
	mm	inch	mm	inch	kg	lbs	
40	1 1/2"	205	8.1	125	4.9	6.5	14.3
50	2"	210	8.3	125	4.9	8.0	17.6
65	2 1/2"	222	8.7	125	4.9	10.4	22.9
80	3"	250	9.8	170	6.7	17	37.5
100	4"	320	12.6	210	8.3	28	61.7
150	6"	415	16.3	270	10.6	48	106
200	8"	500	19.7	330	13.0	75	165
250	10"	605	23.8	420	16.5	125	276
300	12"	725	28.5	480	18.9	225	496
350	14"	733	28.9	480	18.9	235	518
400	16"	990	39.0	620	24.4	535	1180
450	18"	1000	39.4	620	24.4	670	1477
500	20"	1100	43.3	620	24.4	760	1675

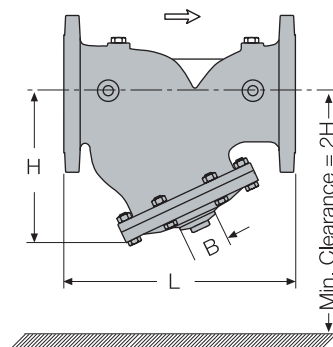

Technical Data

Patterns: "Y" (globe) & angle

Size Range: 40-500 mm; 1 1/2 - 20"

End Connections (Pressure Ratings):

Flanged: ISO PN16, PN25; ANSI Class 150, 300

Threaded: BSP or NPT

Others: Available on request

Standard Materials:

Body: Ductile Iron

Cover: Steel

Seals: NBR

Coating: Polyester Powder, RAL 6017 (Green)

Basket Hole Diameter (mm)

Stainless Steel 304 (Standard)

2"	3-4"	6-20"
1.5	3.0	5.0

Stainless Steel 316 (Optional)

2-6"	8-20"
2.0	3.0

Flow Chart

