

Electrically Controlled On-Off Deluge Valve

Model: FP 400E-3D



UL LISTED

Typical Applications

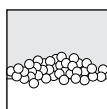

Water/foam fire systems

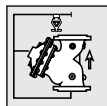

Deluge & spray systems

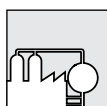

Petrochemical facilities



Flammable materials storage

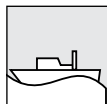

Marine environments

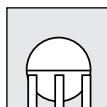

Gas storage tanks

Features and Benefits

- **3-way solenoid valve** – Flexible configuration
- **Remote reset** – Shut-off on remote command
- **One-piece molded elastomeric moving part** – No maintenance required
- **Simple design** – Cost effective
- **Obstacle-free Full bore** – Uncompromising reliability
- **Factory pre-assembled trim** – Out-of-box quality
- **In-line serviceable** – Minimal down time

Optional Features

- **Alarm pressure-switch** (code: P or P7)
- **Explosion-proof** for hazardous locations (code: 7/8/9)
- **Fail-safe open** (energized to close main valve)
- **Seawater service** (add FS as prefix to model)
- **Valve Position Single/Double Limit Switches**

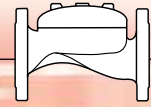

Operation

The BERMAD Model FP 400E-3D is suitable for systems that include electric fire detection and a piping system with a wide variety of open nozzles.

In the SET position, the line-pressure, which is supplied to both the main valve's control chamber [1] and a Hydraulic Relay Valve (HRV-2) [2], through the priming line [3], a Check Valve [4], an Accelerator [5] with priming restriction and a 3-Way Solenoid [6], is trapped by the Check Valve, by the closed HRV-2, and by a closed Manual Emergency Release [7]. The trapped pressure holds the main valve's diaphragm and plug against the valve seat [8], sealing it drip-tight and keeping the system piping dry. The HRV-2 is held closed by the line-pressure through the solenoid.

Under FIRE or TEST conditions, an electric detection system working through a control panel, triggers the solenoid to open the HRV-2, causing water to exit through the Accelerator faster than it can be supplied. Pressure is then released from the main valve control chamber by the opened HRV-2 or the Manual Emergency Release, allowing the main valve to open and water to flow into the system piping and to the alarm device (if mounted).

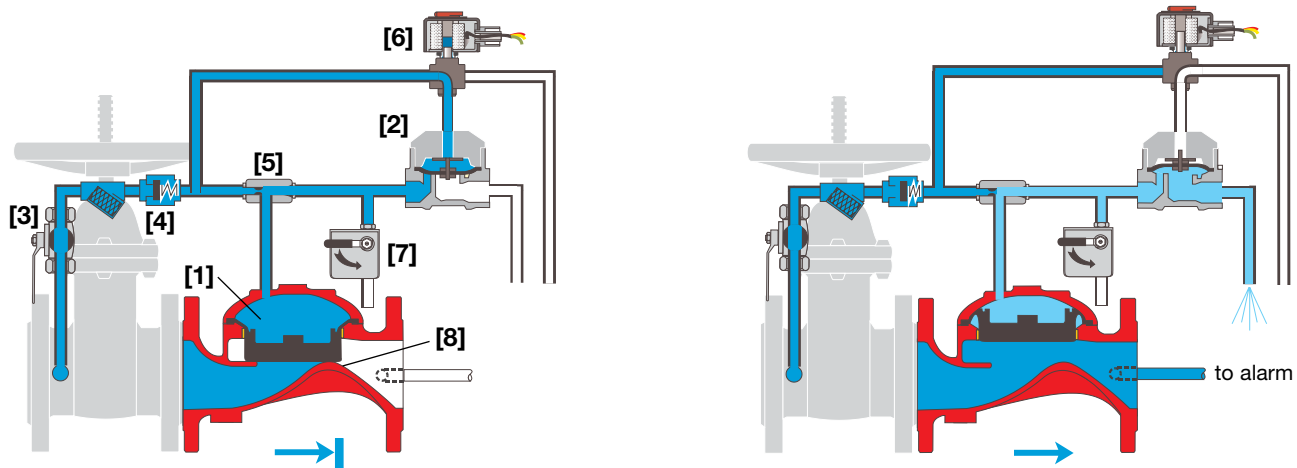

Valve Closed (set position)

Valve Open (operating condition)

Engineer Specifications

- The On-Off deluge valve shall be a UL-Listed, electrically controlled elastomeric type globe valve with a rolling-diaphragm.
- The valve shall have an unobstructed flow path, with no stem guide or supporting ribs.
- Valve actuation shall be accomplished by a fully peripherally supported, one-piece balanced rolling-diaphragm, vulcanized with a rugged radial seal disk. The diaphragm assembly shall be the only moving part.
- The valve shall have removable cover for quick in-line service enabling all necessary inspection and servicing.
- The control trim materials shall be S.S.316 tubing and fittings and plated brass accessories, including, Y strainer, 3-Way Solenoid, Accelerator, Hydraulic Relay Valve (HRV-2) and Manual Emergency Release.
- The control trim shall be supplied as an assembly, pre-assembled and hydraulically tested at an ISO 9000 and 9001 certified factory.
- The Electrically Controlled, On-Off Deluge Valve shall open in response to an electric signal.

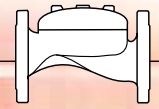

System Components

- 1 - Main Valve, BERMAD FP 400E Series
- 2B - Accelerator with Priming Restriction
- 4B - Priming Strainer
- 7B - Check Valve
- 15B - Manual Emergency Release
- 24B - 3-Way Solenoid
- 26B - Hydraulic Relay Valve (HRV-2)
- Optional
- P - Pressure Switch
- S - Valve Position Limit Switch / Switches

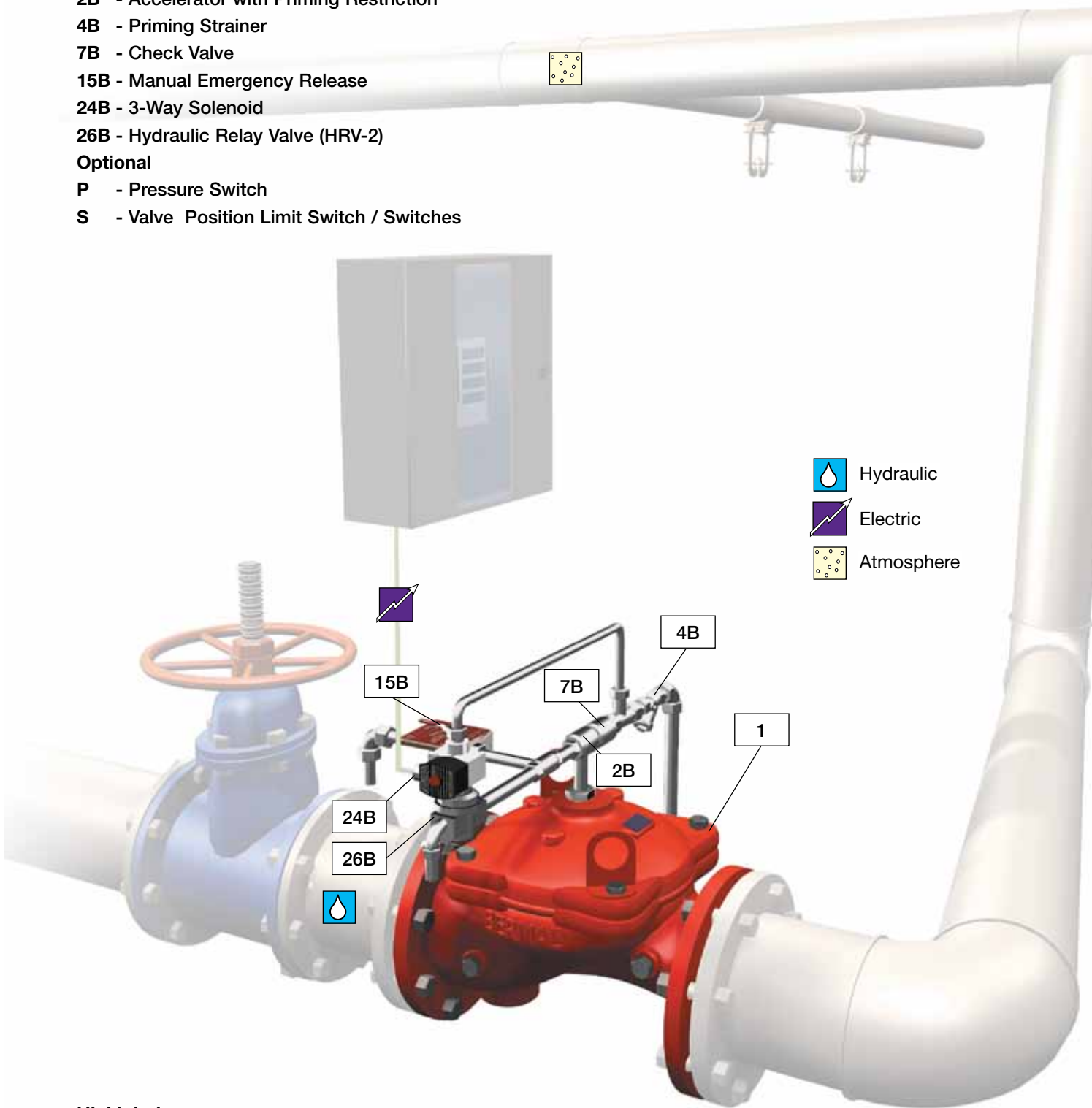

UL Listed

The BERMAD Model FP 400E-3D is UL-Listed.

The installation shall include Indicating and Drain Components.

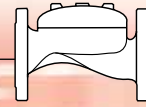

Technical Data

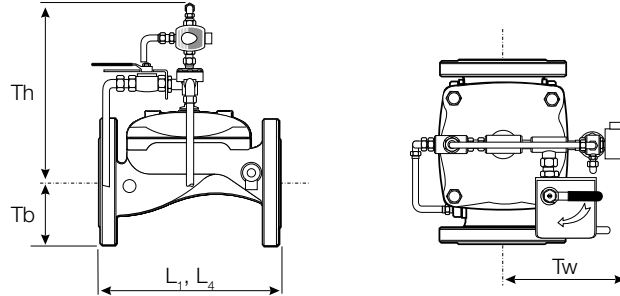

Size	1½"		2"		2½"		3"		4"		6"		8"		10"		12"		
	mm	inch	mm	inch	mm	inch	mm	inch	mm	inch	mm	inch	mm	inch	mm	inch	mm	inch	
Dimensions	L ₁ ⁽¹⁾	205	8 ¹ / ₁₆	205	8 ¹ / ₁₆	205	8 ¹ / ₁₆	257	10 ² / ₁₆	320	12 ¹⁰ / ₁₆	415	16 ⁵ / ₁₆	500	19 ¹¹ / ₁₆	607	23 ¹⁴ / ₁₆	725	28 ⁹ / ₁₆
	L ₄ ⁽²⁾	205	8 ¹ / ₁₆	205	8 ¹ / ₁₆	N/A	N/A	257	10 ² / ₁₆	320	12 ¹⁰ / ₁₆	N/A	N/A	500	19 ¹¹ / ₁₆	N/A	N/A	N/A	N/A
	Tw	255	10 ¹ / ₁₆	255	10 ¹ / ₁₆	255	10 ¹ / ₁₆	255	10 ¹ / ₁₆	255	10 ¹ / ₁₆	255	10 ¹ / ₁₆	255	10 ¹ / ₁₆	255	10 ¹ / ₁₆	255	10 ¹ / ₁₆
	Tb	64	2 ⁸ / ₁₆	78	3 ¹ / ₁₆	89	3 ⁸ / ₁₆	100	3 ¹⁵ / ₁₆	115	4 ⁸ / ₁₆	140	5 ⁸ / ₁₆	172	6 ¹² / ₁₆	204	8 ¹ / ₁₆	242	9 ⁸ / ₁₆
	Th	289	11 ⁶ / ₁₆	289	11 ⁶ / ₁₆	301	11 ¹⁴ / ₁₆	325	12 ¹³ / ₁₆	345	13 ⁹ / ₁₆	420	16 ⁹ / ₁₆	471	18 ⁹ / ₁₆	471	18 ⁹ / ₁₆	588	23 ² / ₁₆

- Notes:**
- L₁ is for flanged ANSI #150 and ISO PN16.
 - L₄ is for grooved end connections (Ductile Iron Only).
 - Provide adequate space around valve for maintenance.
 - Data is for envelope dimensions, specific component positioning may vary.

Connection Standard

- Flanged: ANSI B16.42 (Ductile Iron), B16.5 (Steel & Stainless Steel), B16.24 (Bronze)
- ISO PN16
- Grooved: ANSI/AWWA C606 for 2, 3, 4, 6 & 8"

Water Temperature

- 0.5 – 50°C (33 – 122°F)

Available Sizes

- 1½, 2, 2½, 3, 4, 6, 8, 10 & 12"
- UL-Listed for sizes 1½, 2, 2½, 3, 4, 6, 8 & 10"

Pressure Rating*

- Max. working pressure: 250 psi (17 bar)
- * Pressure rating might be limited due to solenoid valve rating

Manufacturers Standard Materials

Main valve body and cover

- Ductile Iron ASTM A-536

Main valve internals

- Stainless Steel 304 & Cast Iron

Control Trim System

- Brass control components/accessories
- Stainless Steel 316 tubing & fittings

Elastomers

- Nylon fabric reinforced polyisoprene NR

Coating

- Electrostatic Powder Coating Poleyester, Red (RAL 3002)

Optional Materials

Main valve body

- Carbon Steel ASTM A-216 WCB
- Stainless Steel 316
- Ni-Al-Bronze ASTM B-148

Control Trim

- Stainless Steel 316
- Monel® and Ni-Al-Bronze
- Hastalloy C-276

Elastomers

- NBR
- EPDM

Coating

- High Build Epoxy Fusion-Bonded with UV Protection, Anti-Corrosion

Solenoid Pilot Valves

Standard

- 3-Way, direct actuated type
- Brass body
- Main valve closed when de-energized
- Enclosure: General purpose watertight, NEMA 4 and 4X / IP65, Class F
- Power: 24VDC, 8 watts
- UL – Listed

Options (see also ordering guide)

- Hazardous locations:
 - Class I Division 1, Gr. A, B, C, D, T4 (code 7)
 - Class I Division 2, Gr. A, B, C, D, T4
 - ATEX, EEx d IIC T5 (code 9)
- Voltage: see ordering guide (voltage options)
- Stainless Steel 316 body material (code K)

