

## Pressure Differential Sustaining Control Valve (PDSCV)

### Model 43T - 06

The BERMAD model 43T-06 is an elastomeric hydraulic line pressure operated differential sustaining valve, specifically designed for advanced fire protection systems and the latest industry standards.

The 43T-06 is equipped with an adjustable differential pilot valve and is used to sustain the differential between two different points.

When the differential between the two sensed pressures rises above the pre-set value the pilot valve opens the main valve regulating the pressure and keeping the differential at the pre-set maximum.

The 43T-06 is ideal for balanced foam proportioning systems, also as a safeguard for dosing pump flow overload.

As an option the 43T-06 can be fitted with a valve position indicator that can include a limit switch suitable for Fire & Gas monitoring systems.

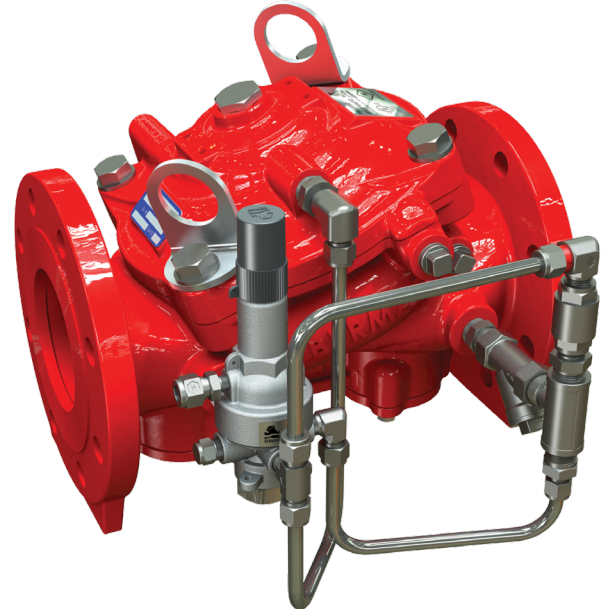

(for Illustration Only)

### Benefits and Features

- **Safety and reliability**
  - Time tested, simple, fail-safe actuation
  - Single piece, rugged elastomeric diaphragm seal - VRSD technology
  - Obstacle-free, uninterrupted flow path
  - No mechanical moving parts
- **High performance**
  - Very high flow efficiency
  - Straight through flow Y-type body
  - Rated up to PN25 / 365 psi
- **Quick and easy maintenance**
  - In-line serviceable
  - Fast and easy cover removal

### Typical Applications

- Pump overload & cavitation protection
- Foam balanced pressure proportioning systems
- Pump flow safeguard
- Foam concentrate recirculation

### Approvals



ABS  
American Bureau of Shipping  
Type Approval



Lloyd's Register  
Type Approval



Det Norske Veritas  
Type Approval

### Additional Features

- High Build epoxy coating
- Linear valve position indicator
- Pressure gauges

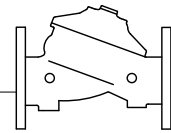

## Operation

(for Illustration Only)

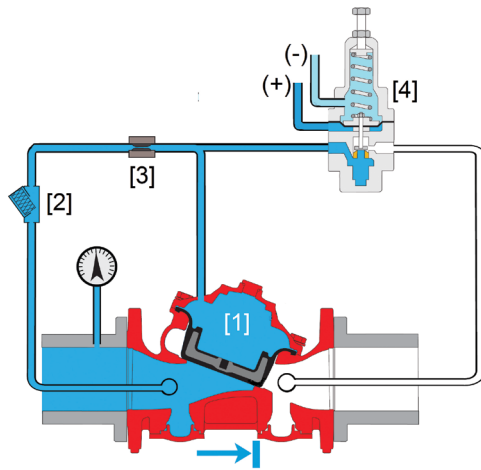

**Valve Closed**

Differential pressure below set maximum

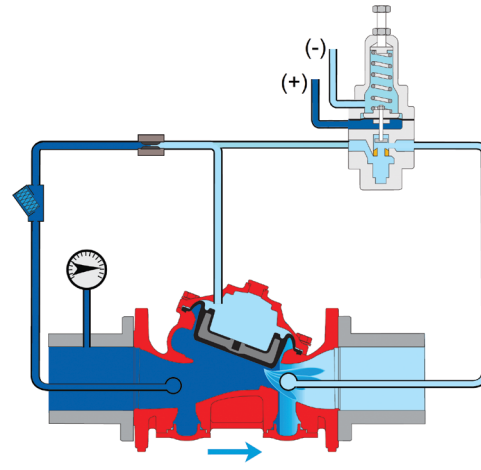

**Valve Open (pressure-relief)**

Differential pressure at or above set maximum

The BERMAD model 43T-06 is held closed by inlet pressure in the control chamber [1] supplied via the pilot line filter [2] and the restriction orifice [3]. To open the valve the pressure in the control chamber must be released by way of the pilot valve [4] opening and releasing pressure in the control chamber to the downstream of the valve.

The pilot valve senses two pressures, a higher pressure (+) and a lower pressure (-). Should the differential between these two pressures exceed the set maximum (determined by the pilot valve adjusting screw) the pilot valve will open, releasing pressure from the valve control chamber allowing the valve to open. This relieves the higher pressure in the pipeline maintaining the differential pressure below the set maximum.

Should the differential pressure fall below the set maximum the pilot valve will throttle or close; allowing pressure to accumulate in the valve control chamber, causing the main valve to throttle or close, sustaining differential pressure in the pipeline at or below the pilot valve setting.

## System P&ID

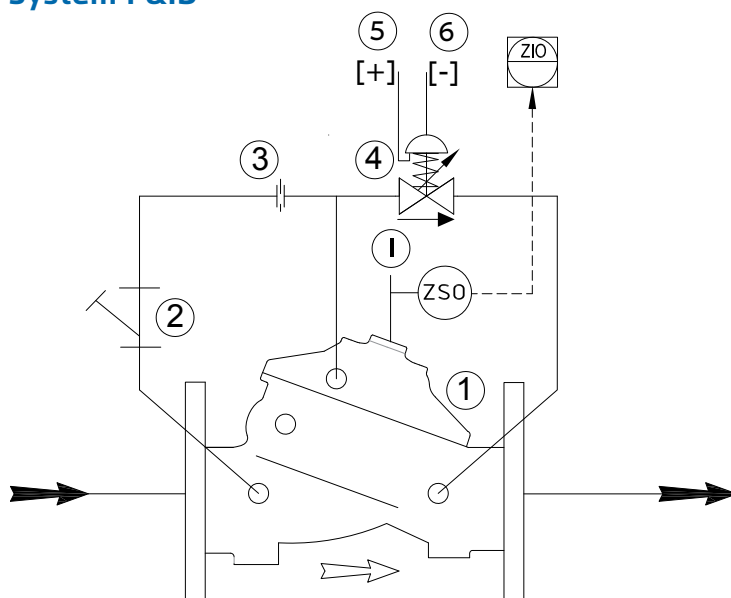

### Components

- 1 BERMAD 400Y Main Valve
- 2 Priming strainer
- 3 Restriction orifice
- 4 Differential sustaining pilot valve
- 5 High pressure sensing
- 6 Low pressure sensing

### Optional System Items

- ZS Limit Switch Assembly
- I Visual Indicator

See also Factory Fitted Options under the Valve Code Designations on the last page

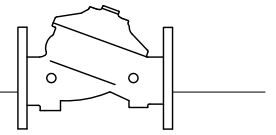

## System Installation

A typical installation of the BERMAD model 43T-06 uses the automatic valve actuation via a pilot control to open the 43T-06 in response to an increase in differential pressure between two points. The 43T-06 is ideally suited for regulation in balanced pressure proportioning systems or foam dosing applications.

### Balanced Pressure Proportioning System

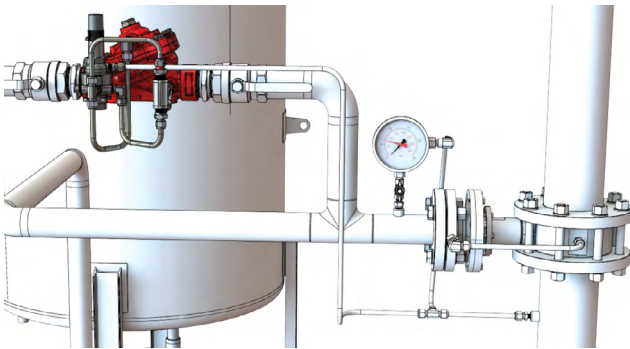

A typical installation is in a Balanced Pressure Proportioning System, where the BERMAD 43T-06 is installed on the foam concentrate return pipe, and is used to maintain the correct pressure differential between the firewater system pressure and the foam supply pressure. This ensures an accurate and steady foam to water ratio regardless of fluctuations of service flow or pressure.

Note: All illustrations are for demonstrational purposes only.

## Engineering Specifications

The pressure differential sustaining control valve shall be 25 bar / 365 psi rated, with a straight-through Y-type-body. The valve shall have an unobstructed flow path, with no stem guide or supporting ribs.

Valve actuation shall be accomplished by a single-piece, rolling diaphragm bonded with a rugged radial seal disk.

The diaphragm assembly shall be the only moving part.

Removing the valve cover for inspection or maintenance shall be in-line and not require removing the control trim.

The water control valve and its entire control trim shall be supplied pre-assembled and hydraulically tested by a factory certified to ISO 9000 and 9001 standards.

### Dosing Pump Applications

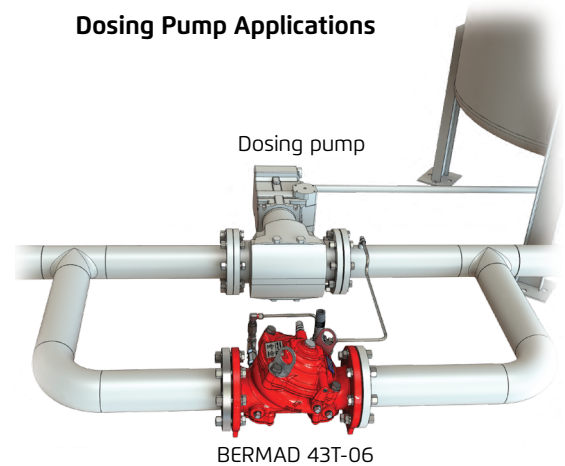

BERMAD 43T-06

The 43T 06 senses when the maximum allowable flow rate for the dosing pump has been reached and will open, diverting the excess flow through the bypass preventing dangerous pump overload.

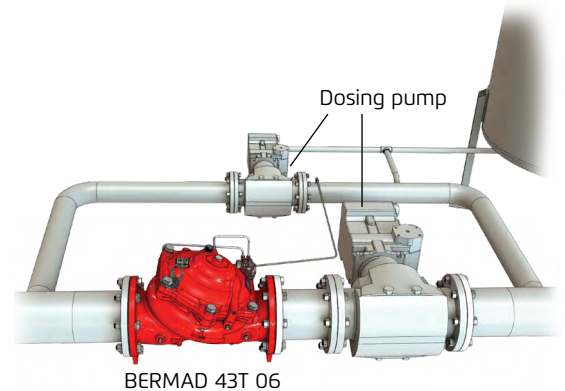

BERMAD 43T 06

The 43T 06 senses when the maximum flow rate for the foam concentrate dosing pump has been reached and opens when necessary sharing the flow through a secondary pump.

# BERMAD Fire Protection

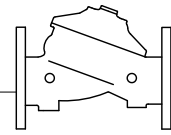

Model FP 400Y - 43T - 06

400Y Series

## Technical Data

### Available Sizes (inch)

- Flanged - 1½, 2, 3, 4, 6, 8, 10, 12, 14 & 16"
- Grooved - 1½, 2, 3, 4, 6 & 8"
- Threaded - 1½ & 2"

### Pressure Rating

- ANSI#150 - 16 bar / 235 psi
- ANSI#300 - 1½" to 10" 25 bar / 365 psi  
12" to 16" 20 bar / 300 psi
- Grooved/Threaded - See in code designations table below
- Pressure differential setting range: 0.5-3 bar / 7-43 psi
- Maximum recommended pressure differential across the valve: 12 bar / 175 psi

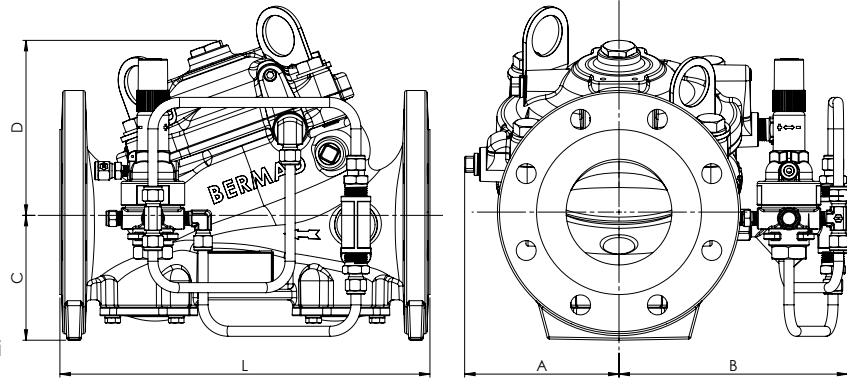

### Elastomer

- HTNR - Fabric Reinforced High Temperature Compound - See engineering data

Valve Size	1½" DN40		2" DN50		3" DN80		4" DN100		6" DN150		8" DN200		10" DN250		12" DN300		14" DN350		16" DN400	
	mm	in	mm	in	mm	in	mm	in	mm	in	mm	in	mm	in	mm	in	mm	in	mm	in
L <sup>(1)</sup>	230	9.1	230	9.1	310	12.2	350	13.8	480	18.9	600	23.6	730	28.7	850	33.5	980	38.6	1100	43.3
L <sup>(2)</sup>	230	9.1	238	9.4	326	12.8	368	14.5	506	19.9	626	24.6	730	28.7	888	35	980	38.6	1100	43.3
A	77.5	3	77.5	3	100	3.94	115	4.53	140	5.51	172	6.77	204	8	242	9.53	242	9.53	242	9.53
B	155	6.1	155	6.1	251	9.88	266	10.47	372	14.65	490	19.29	490	19.29	656	25.83	656	25.83	656	25.83
C	64	2.52	77	3.03	106	4.17	121	4.76	140	5.51	172	6.77	204	8.03	247	9.72	272	10.71	316	12.44
D	120	4.69	120	4.69	146	5.75	158	6.22	228	9	295	11.65	296	11.65	441	17.36	441	17.36	415	16.3
Kv / Cv <sup>(4)</sup>	68 / 79		80 / 92		190 / 219		345 / 398		790 / 912		1160 / 1340		1355 / 1565		2370 / 2737		2850 / 3292		3254 / 3758	
Leq <sup>(3)</sup> : m/ft	2 / 7		5 / 16		7 / 23		9 / 30		15 / 49		27 / 89		62 / 203		52 / 171		59 / 194		88 / 289	
Kg/lb flanged#150/ISO16	17.9 / 39.4		19.3 / 42.5		34 / 74.8		44 / 95.8		87.3 / 192		150 / 331		180 / 397		323 / 712		356 / 784		403 / 886	

Notes: <sup>(1)</sup> Refers to the length dimensions for Raised Face ANSI #150, ISO 16 Flanged, Threaded and Grooved valves

<sup>(2)</sup> Refers to the length dimensions for Raised Face ANSI #300 and ISO 25 Flanged valves

<sup>(3)</sup> Leq (Equivalent Pipe Length) refers to a fully opened valve with turbulent flow in new steel pipe schedule 40, values given for general consideration only

<sup>(4)</sup> Kv/Cv values given for a fully opened valve

<sup>(5)</sup> Exact dimensions for the trim envelope may vary with specific component positioning

## Valve Code Designations

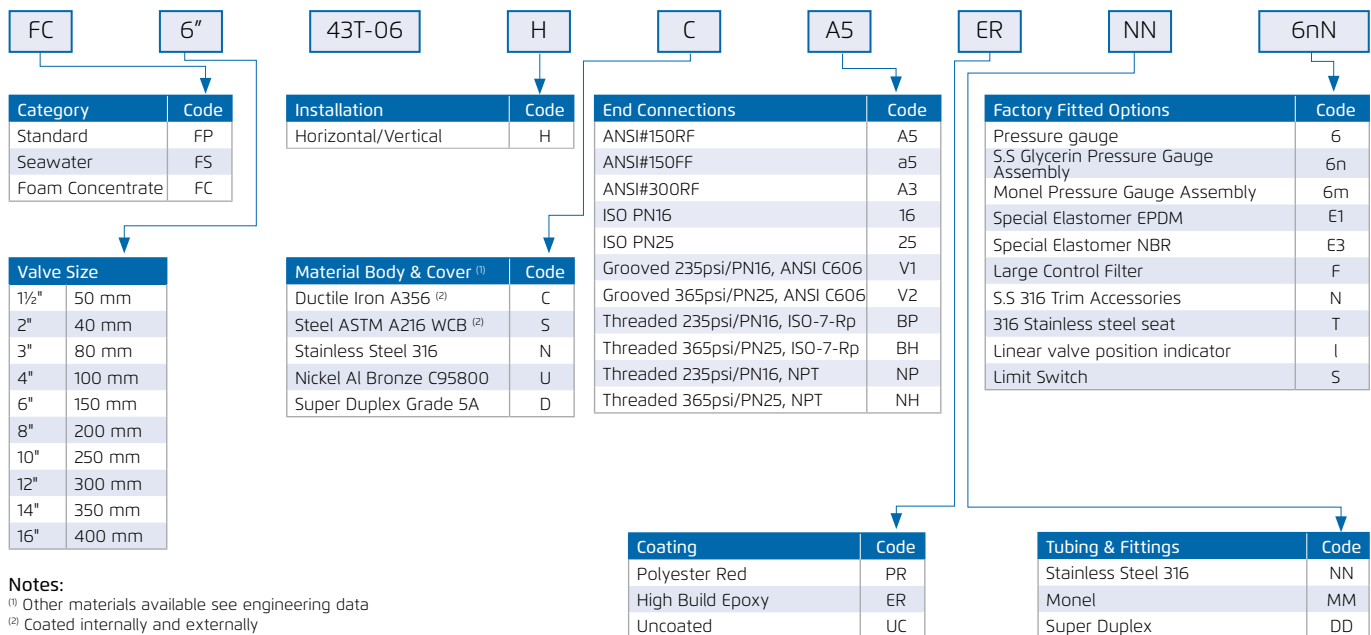

### Notes:

<sup>(1)</sup> Other materials available see engineering data

<sup>(2)</sup> Coated internally and externally



www.bermad.com

© Copyright 2007-2012 Bermad CS Ltd. All Rights Reserved. The information contained in this document is subject to change without notice. BERMAD shall not be liable for any errors contained herein. Rev.1 June 2017