

### WW-400 Basic Valve

The basic Model WW-400 diaphragm actuated hydraulically operated valve is at the leading edge of control valve design.

It combines simple and reliable construction with superior performance, while at the same time being virtually free of the typical limitations associated with other single chambered valves. These automatic water control valves are designed for vertical or horizontal installation and are available in diameter sizes of 1 1/2-16"; DN40 - DN400, in a wide range of materials and end connections.

The design of the WW-400 valve body includes a full bore seat with unobstructed flow path, free of any in-line ribs, supporting cage, or shafts.

The unique hydro-dynamic globe design provides high flow capabilities with minimum head loss. The cover is removable for quick in-line inspection and service. The internal design of the WW-400 valve is based on innovative technology using advanced rubber-based materials to achieve a solid, one piece elastomeric assembly including a flexible fabric reinforced diaphragm, vulcanized with a rugged radial seal disk. The diaphragm is carefully balanced and peripherally supported to avoid distortion and to protect the elastomer, resulting in long-life and controlled actuation even under harsh conditions. One diaphragm and spring fully meet the valve's operating pressure range requirements. The diaphragm assembly can be easily removed from the valve body with no need for disassembling the valve from the line.

The Model WW-400 Basic Valve uses valve differential pressure to power the diaphragm assembly open or closed. The lower side of the diaphragm, which serves to cushion the closing of the valve, is exposed to downstream pressure through a dynamic peripheral passageway that its width responds to differential pressure and flow along the downstream side of the valve. The pressure in the control chamber varies, usually resulting from the combined action of a regulating pilot and a fixed orifice. This varying pressure modulates the valve to open or close.



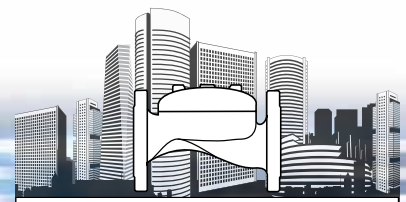

### On-Off Modes

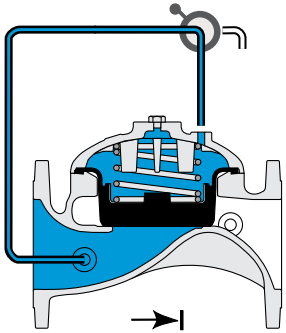

#### Closed Position

Line pressure applied to the control chamber of the valve creates a hydraulic force that moves the valve to the closed position and provides drip tight sealing.

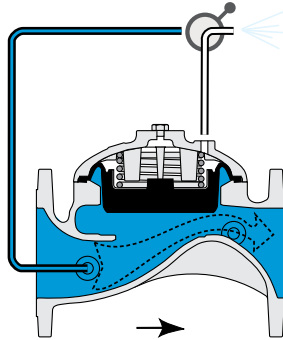

#### Open Position

Discharging the pressure from the control chamber to atmosphere or some other lower pressure zone, causes the line pressure acting on the plug to open the valve.

### 2-Way Modulating Modes

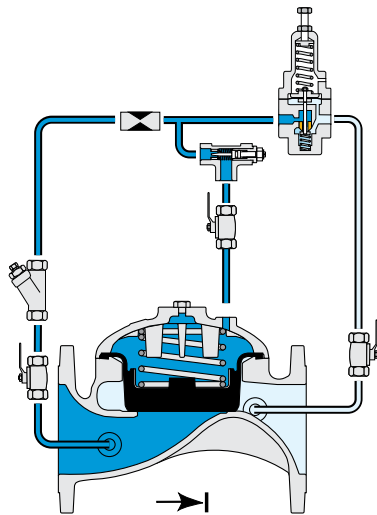

#### Closed Position

The closed adjustable pilot valve traps line pressure in the upper control chamber. The resulting superior force moves the valve to the fully closed position and provides drip-tight sealing.

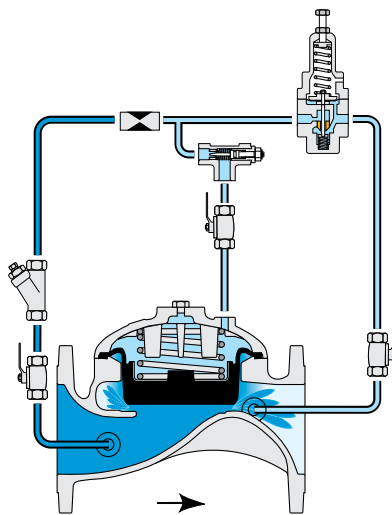

#### Modulating Position

The pilot valve senses line pressure changes and opens or closes accordingly. It controls the accumulated pressure in the valve upper control chamber, causing main valve to modulate to an intermediate position and maintain the preset pressure value.

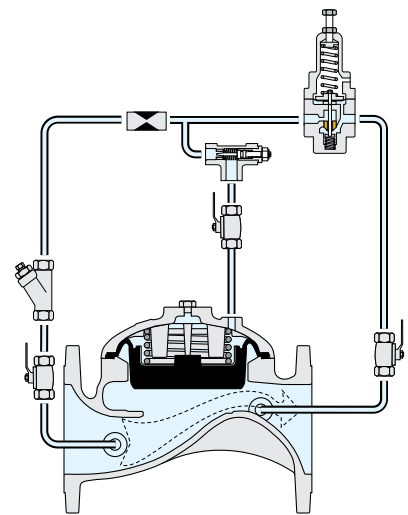

#### Open Position

The open pilot valve releases line pressure from the upper control chamber. The line pressure acting on both the lower control chamber and the seal-disk, moves the valve to the open position.

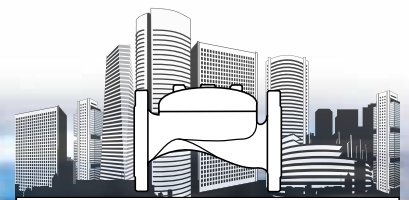

### On-Off Modes

#### [1] Fastening Bolts

Only four bolts (up to 10"; DN250 valve) fasten valve cover to body, ensuring quick in-line inspection and service.

#### [2] Valve Cover

Locates, centralizes and fastens diaphragm and spring ensuring smooth and accurate performance. Simple construction enables quick in-line inspection and service.

#### [3] Auxiliary Closing Spring

One single spring fully meets valve requirements for operating pressure range, ensuring low opening pressure and secured closing.

#### [4] Diaphragm Assembly

One piece elastomeric assembly that includes a peripherally supported flexible diaphragm, vulcanized with a rugged radial seal disk. No need for special types of diaphragms to meet different operating conditions. Progressive dynamic guidance, resulting in exceptionally stable action and restrained closing. Valve opens and closes drip tight even with very low pressure supply. Perfectly balanced diaphragm with no distortion caused by uneven hydraulic forces on shut-off or during regulation. Exceptionally stable and chatter-free action during shut-off and pressure regulation.

#### [5] Body Threads

No need for nuts, simplifying valve disassembling and assembling for maintenance.

#### [6] Wide Body Valve

Hydro-dynamically designed for efficient flow with minimal pressure loss and excellent resistance to cavitation.

[6.1] Diaphragm Supporting & Guiding

[6.2] Diaphragm Balancing Chamber

[6.3] **Valve Seat:** Full bore, valve port area clear of obstructions; no ribs or stem guides. Flow entrance is vertical to seal disk.

[6.4] **End Connections:** Conforms to pressure ratings and standards of: ISO, ANSI, JIS, BS, and others.

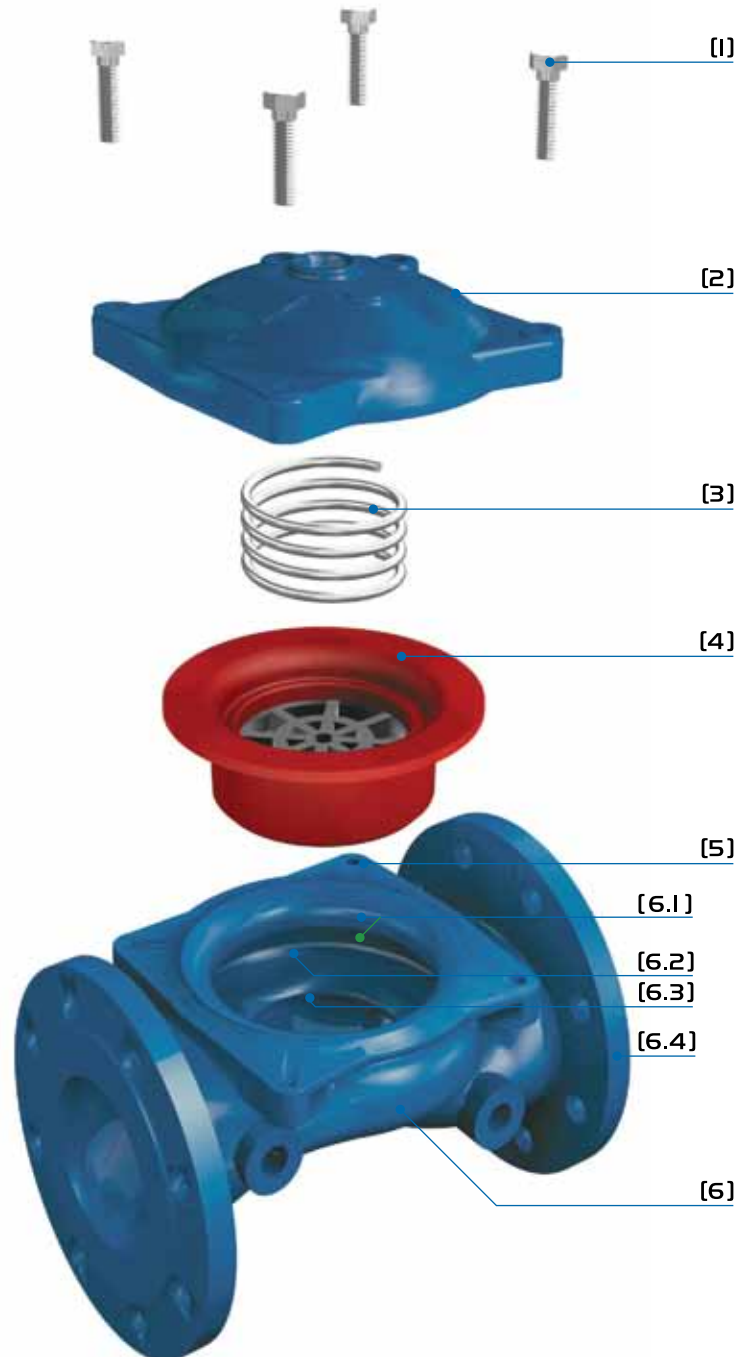

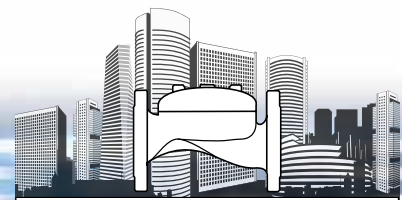

### Technical Specifications

#### Available Sizes & Patterns

DN40 - DN400 (1 1/2-16"): Globe

DN50 - DN100 (2-4"): Angle

#### Connection Standard

**Flanged:** ISO 7005-2 (ISO 10 & 16)

**Threaded:** BSP (Rp ISO 7/1) or NPT (DN40 - DN80)

**Grooved:** ANSI C606

#### Operating pressure Range

0.5 - 16 bar

#### Pressure Rating

PN16

#### Water Temperature

Up to 50°C

#### Standard Materials

##### ■ Main valve body and cover

Ductile Iron to EN 1563

##### ■ Diaphragm Assembly

□ DN40-100: Reinforced NR with Plastic Vulcanized Radial Seal Disk

□ DN150-250: Reinforced NR with Iron Vulcanized Radial Seal Disk

□ DN300-400: Reinforced NR with Iron Vulcanized Radial Seal Disk & Stainless Steel Upper Guide

##### ■ Coating

Electrostatic Polyester Powder, RAL 5010 (Blue)

#### Optional

Epoxy Fusion-Bonded Blue RAL 5005

**Note:** Internal & External coating applied on Ductile Iron or Cast Steel Castings only.

##### ■ Control Trim

Stainless Steel 316 fittings & tubing

##### ■ Elastomers

NR, (Nylon fabric reinforced Polyisoprene)

#### Optional Materials

##### ■ Main valve body and cover

□ Carbon Steel to EN 10083-1

□ Stainless Steel 316 to EN 10088-1

□ Nickel Aluminum Bronze to BS-EN 1400 AB-2

□ Hastelloy C-276

Other materials on request

##### ■ Control Trim

□ Nickel Aluminum Bronze

□ Hastalloy C-276 accessories

□ Monel fittings & tubing

##### ■ Elastomers

□ NBR, (Nylon fabric reinforced Nitrile, Buna-N)

□ EPDM, (Nylon fabric reinforced, EPDM)

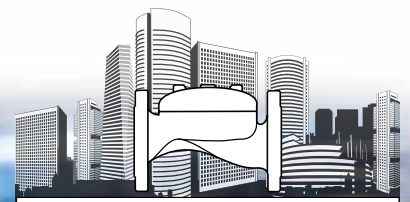

### Globe Pattern

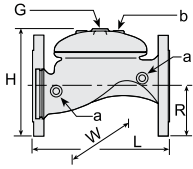

Size	Flanged									
	DN50	DN65	DN80	DN100	DN150	DN200	DN250	DN300	DN350	DN400
L (mm)	205	205	250	320	415	500	605	725	742	742
H (mm)	155	178	210	242	345	430	460	635	655	965
W (mm)	155	178	200	223	306	365	405	580	587	600
R (mm)	78	89	100	112	140	170	202	242	260	300
Weight (kg)	9	10.5	19	28	68	125	140	290	358	377
(inch) a	4x1/4" NPT				4x3/8" NPT			4x1/2" NPT		
(inch) G	3/4" G				2" G			2" G		
(inch) b	2x1/4" NPT				1x1/4" NPT+1x3/8" NPT			3x3/8" NPT		

Size	Flanged							
	DN40	DN50	DN65	DN80	DN50	DN80	DN100	DN150
L (mm)	153	180	210	255	205	250	320	415
H (mm)	87	114	132	165	108	155	191	302
W (mm)	98	119	129	170	119	170	204	306
R (mm)	29	39	45	55	31	46	61	85
Weight (kg)	2	4	5.7	13	5	10.6	16.2	49
(inch) a	4x1/4" NPT				4x1/4" NPT			4x3/8" NPT
(inch) G	3/4" G				2" G			2" G
(inch) b	2x1/4" NPT				2x1/4" NPT			*

\* 1x1/4" NPT+1x3/8" NPT

### Angle Pattern

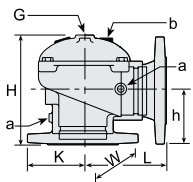

Size	Flanged							
	DN40	DN50	DN65	DN80	DN50	DN80	DN100	DN150
L (mm)	86	110	110	120	160	121	153	160
H (mm)	136	180	184	194	223	160	205	223
W (mm)	119	131	170	170	204	155	200	223
h (mm)	61	93	80	90	112	83	101	112
K (mm)	56	66	55	45	58	78	100	112
Weight (kg)	4.4	5.8	11	10	16	9	17	26
(inch) a	4x1/4" NPT							
(inch) G	3/4" G							
(inch) b	2x1/4" NPT							

### Control Chamber Displacement Volume (liter)

DN50	DN65	DN80	DN100	DN150	DN200	DN250	DN300-400
0.113	0.179	0.291	0.668	1.973	3.858	3.858	13.75

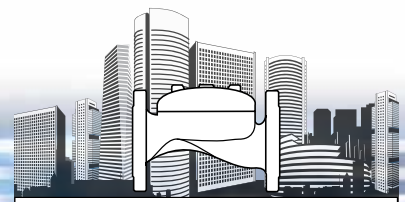

## Globe Pattern

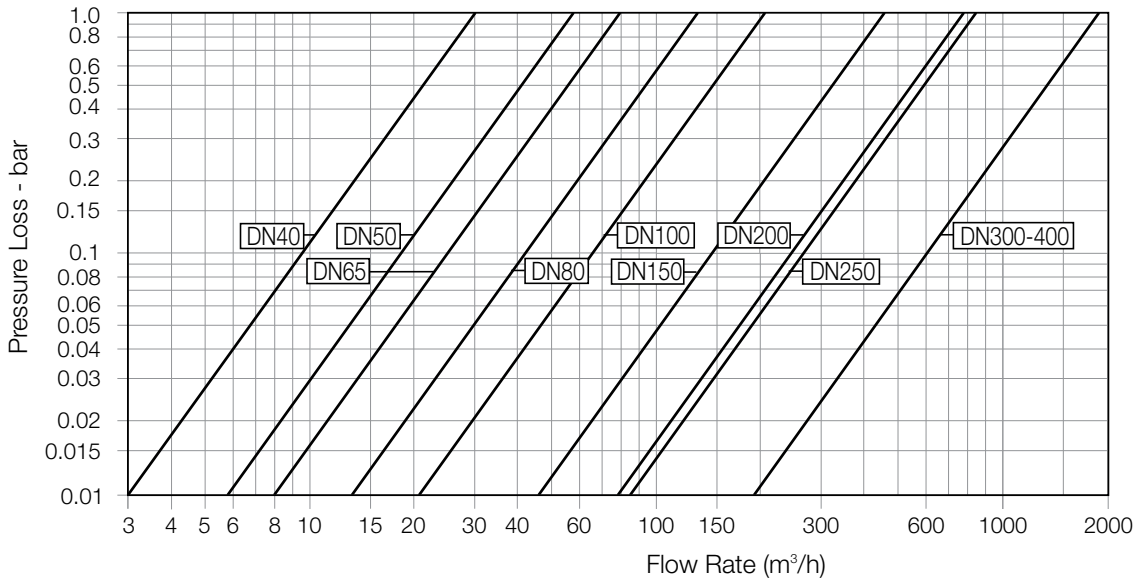

## Angle Pattern

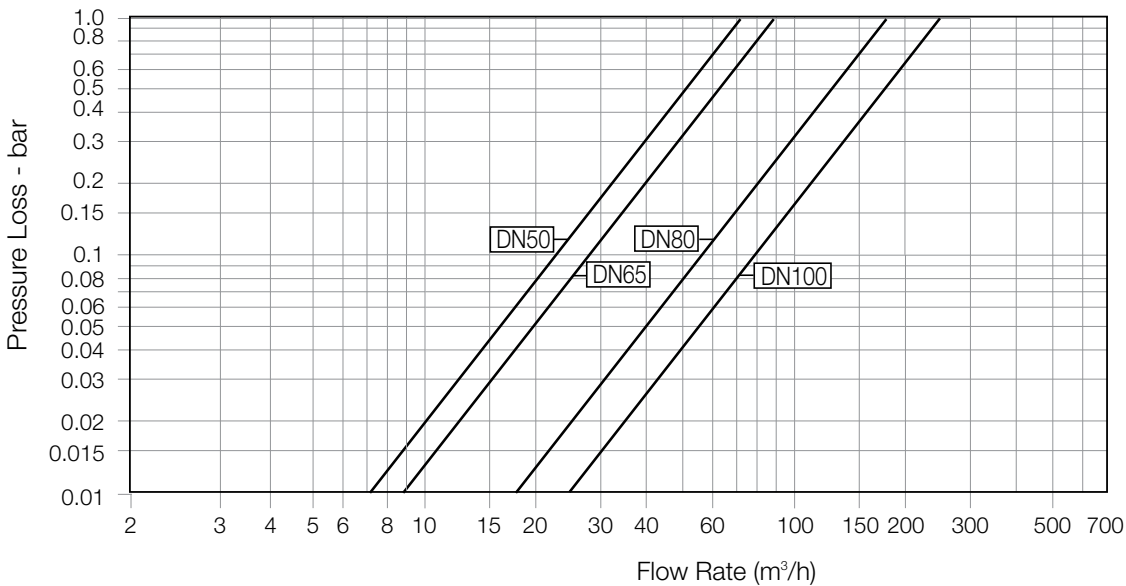

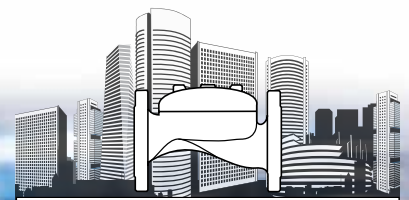

**Si** Metric

		Size	DN50	DN65	DN80	DN100	DN150	DN200	DN250	DN300-400
Globe Pattern		KV	57	78	136	204	458	781	829	1,932
		K	3.2	4.2	2.9	4.0	4.0	4.4	3.9	3.6
		Leq - m	9.1	12.1	13.7	14	27.4	45.8	108	57

### Differential Pressure Calculation

Valve flow coefficient, Kv or Cv 
$$Kv(Cv) = Q \sqrt{\frac{Gf}{\Delta P}}$$

**Where:**

Kv = Valve flow coefficient (flow in m<sup>3</sup>/h at 1bar Diff. Press.)

Cv = Valve flow coefficient (flow in gpm at 1psi Diff. Press.)

(Cv = 1.155 Kv)

Q = Flow rate (m<sup>3</sup>/h; gpm)

ΔP = Differential pressure (bar; psi)

Gf = Liquid specific gravity (Water = 1.0)

Flow resistance or Head loss coefficient 
$$K = \Delta H \frac{2g}{V^2}$$

**Where:**

K = Flow resistance or Head loss coefficient (dimensionless)

ΔH = Head loss (m; feet)

V = Nominal size flow velocity (m/sec; feet/sec.)

g = Acceleration of gravity (9.81 m/sec<sup>2</sup>; 32.18 feet/sec<sup>2</sup>)

Equivalent Pipe Length, Leq 
$$Leq = Lk \cdot D$$

**Where:**

Leq = Equivalent nominal pipe length (m; feet)

Lk = Equivalent length coefficient for turbulent flow in clean commercial steel pipe (SCH 40)

D = Nominal pipe diameter (m; feet)

**Note:** The Leq values given are for general consideration only.

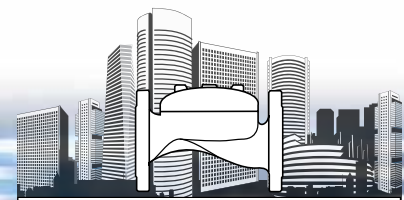

### Technical Specifications

#### Available Sizes & Patterns

1½"-16": Globe  
2"-4": Angle

#### Connection Standard

**Flanged:** ANSI B16.42  
**Threaded:** NPT (1½"- 3")  
**Grooved:** ANSI C606

#### Operating pressure Range

7 - 230 psi

#### Pressure Rating

Ductile Iron- #150

#### Water Temperature

Up to 122°F

#### Standard Materials

- **Main valve body and cover**
  - Ductile Iron to ASTM A536 65-45-12 (coated)
- **Diaphragm Assembly**
  - 1½"-4": Reinforced NR with Plastic Vulcanized Radial Seal Disk
  - 6"-10": Reinforced NR with Iron Vulcanized Radial Seal Disk
  - 12"-16": Reinforced NR with Iron Vulcanized Radial Seal Disk & Stainless Steel Upper Guide
- **Coating**
  - Electrostatic Polyester Powder, RAL 5010 (Blue)

#### Optional

Epoxy Fusion-Bonded Blue RAL 5005

**Note:** Internal & External coating applied on Ductile Iron or Cast Steel Castings only.

- **Control Trim**
  - Stainless Steel 316 fittings & tubing
- **Elastomers**
  - NR, (Nylon fabric reinforced Polyisoprene)

#### Optional Materials

- **Main valve body and cover**
  - Cast Steel ASTM A216 Grade WCB (coated)
  - Nickel Aluminum Bronze ASTM B148 C95800
  - Stainless Steel 316 ASTM A351 Grade CF8M
  - Hastelloy C-276

Other materials on request

- **Control Trim**
  - Nickel Aluminum Bronze
  - Hastalloy C-276 accessories
  - Monel fittings & tubing
- **Elastomers**
  - NBR, (Nylon fabric reinforced Nitrile, Buna-N)
  - EPDM, (Nylon fabric reinforced, EPDM)



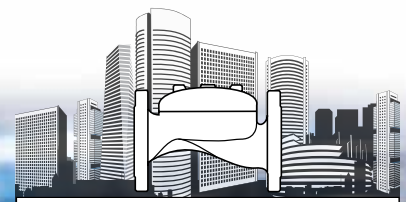

**US** English

### Globe Pattern

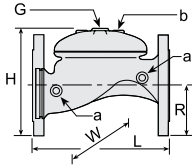

Size	Flanged								
	2"	2½"	4"	6"	8"	10"	12"	14"	16"
L (inch)	8 <sup>1</sup> / <sub>16</sub>	8 <sup>1</sup> / <sub>16</sub>	8 <sup>1</sup> / <sub>16</sub>	12 <sup>5</sup> / <sub>8</sub>	19 <sup>11</sup> / <sub>16</sub>	23 <sup>13</sup> / <sub>16</sub>	28 <sup>9</sup> / <sub>16</sub>	29 <sup>1</sup> / <sub>4</sub>	29 <sup>1</sup> / <sub>4</sub>
H (inch)	6 <sup>1</sup> / <sub>8</sub>	7	9 <sup>1</sup> / <sub>2</sub>	13 <sup>9</sup> / <sub>16</sub>	16 <sup>15</sup> / <sub>16</sub>	18 <sup>1</sup> / <sub>8</sub>	25	25 <sup>13</sup> / <sub>16</sub>	38
W (inch)	6 <sup>1</sup> / <sub>8</sub>	7	8 <sup>3</sup> / <sub>4</sub>	12	14 <sup>3</sup> / <sub>8</sub>	15 <sup>15</sup> / <sub>16</sub>	22 <sup>7</sup> / <sub>8</sub>	23 <sup>1</sup> / <sub>8</sub>	23 <sup>5</sup> / <sub>8</sub>
R (inch)	3 <sup>1</sup> / <sub>16</sub>	3 <sup>1</sup> / <sub>2</sub>	4 <sup>1</sup> / <sub>2</sub>	5 <sup>1</sup> / <sub>2</sub>	6 <sup>11</sup> / <sub>16</sub>	7 <sup>15</sup> / <sub>16</sub>	9 <sup>1</sup> / <sub>2</sub>	10 <sup>1</sup> / <sub>4</sub>	11 <sup>13</sup> / <sub>16</sub>
Weight (lb)	19.8	23.1	61.7	149.9	275.6	308.6	639.3	789.2	831.1
(inch) (inch)	4x¼" NPT			4x <sup>3</sup> / <sub>8</sub> " NPT			4x½" NPT		
(inch) (inch)	¾" G			2" G			2" G		
(inch) (inch)	2x¼" NPT			1x¼" NPT+1x <sup>3</sup> / <sub>8</sub> " NPT			3x <sup>3</sup> / <sub>8</sub> " NPT		

Size	Threaded				Grooved			
	1½"	2"	2½"	3"	2"	3"	4"	6"
L (inch)	6	7 <sup>1</sup> / <sub>16</sub>	8 <sup>1</sup> / <sub>4</sub>	10	8 <sup>1</sup> / <sub>16</sub>	8 <sup>13</sup> / <sub>16</sub>	12 <sup>5</sup> / <sub>8</sub>	16 <sup>5</sup> / <sub>16</sub>
H (inch)	3 <sup>3</sup> / <sub>8</sub>	4 <sup>16</sup> / <sub>16</sub>	5 <sup>3</sup> / <sub>16</sub>	6 <sup>1</sup> / <sub>2</sub>	4 <sup>1</sup> / <sub>4</sub>	6 <sup>1</sup> / <sub>16</sub>	7 <sup>1</sup> / <sub>2</sub>	15 <sup>7</sup> / <sub>8</sub>
W (inch)	3 <sup>7</sup> / <sub>8</sub>	4 <sup>11</sup> / <sub>16</sub>	5 <sup>1</sup> / <sub>16</sub>	6 <sup>11</sup> / <sub>16</sub>	4 <sup>11</sup> / <sub>16</sub>	6 <sup>1</sup> / <sub>16</sub>	8	12 <sup>1</sup> / <sub>16</sub>
R (inch)	1 <sup>1</sup> / <sub>8</sub>	1 <sup>1</sup> / <sub>2</sub>	1 <sup>13</sup> / <sub>16</sub>	2 <sup>3</sup> / <sub>16</sub>	1 <sup>3</sup> / <sub>16</sub>	1 <sup>6</sup> / <sub>8</sub>	2 <sup>3</sup> / <sub>8</sub>	3 <sup>3</sup> / <sub>8</sub>
Weight (lb)	4.4	8.8	12.6	28.7	11.0	23.4	37.5	108.0
(inch) (inch)	4x¼" NPT				4x¼" NPT			4x <sup>3</sup> / <sub>8</sub> " NPT
(inch) (inch)	¾" G				¾" G			2" G
(inch) (inch)	2x¼" NPT				2x¼" NPT			*

\* 1x¼" NPT+1x<sup>3</sup>/<sub>8</sub>" NPT

### Angle Pattern

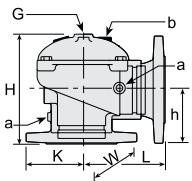

Size	Threaded			Grooved		Flanged			
	2"	2½"	3"	3"	4"	2"	3"	4"	
L (inch)	3 <sup>3</sup> / <sub>8</sub>	4 <sup>5</sup> / <sub>16</sub>	4 <sup>3</sup> / <sub>8</sub>	4 <sup>3</sup> / <sub>4</sub>	6 <sup>5</sup> / <sub>16</sub>	4 <sup>3</sup> / <sub>4</sub>	6	6 <sup>1</sup> / <sub>4</sub>	
H (inch)	5 <sup>3</sup> / <sub>8</sub>	7 <sup>1</sup> / <sub>16</sub>	7 <sup>1</sup> / <sub>4</sub>	7 <sup>5</sup> / <sub>8</sub>	8 <sup>3</sup> / <sub>4</sub>	6 <sup>5</sup> / <sub>16</sub>	8 <sup>1</sup> / <sub>16</sub>	8 <sup>3</sup> / <sub>4</sub>	
W (inch)	4 <sup>11</sup> / <sub>16</sub>	5 <sup>3</sup> / <sub>16</sub>	6 <sup>11</sup> / <sub>16</sub>	6 <sup>11</sup> / <sub>16</sub>	8	6 <sup>1</sup> / <sub>8</sub>	7 <sup>7</sup> / <sub>8</sub>	8 <sup>3</sup> / <sub>4</sub>	
h (inch)	2 <sup>3</sup> / <sub>8</sub>	3 <sup>11</sup> / <sub>16</sub>	3 <sup>1</sup> / <sub>8</sub>	3 <sup>9</sup> / <sub>16</sub>	4 <sup>1</sup> / <sub>2</sub>	3 <sup>1</sup> / <sub>4</sub>	4	4 <sup>7</sup> / <sub>16</sub>	
K (inch)	2 <sup>3</sup> / <sub>16</sub>	2 <sup>5</sup> / <sub>8</sub>	2 <sup>3</sup> / <sub>16</sub>	1 <sup>3</sup> / <sub>4</sub>	2 <sup>5</sup> / <sub>16</sub>	3 <sup>1</sup> / <sub>16</sub>	3 <sup>15</sup> / <sub>16</sub>	4 <sup>7</sup> / <sub>16</sub>	
Weight (lb)	9.7	12.8	24.3	22.0	35.3	19.8	37.5	57.3	
(inch) (inch)	4x¼" NPT								
(inch) (inch)	¾" G								
(inch) (inch)	2x¼" NPT								

### Control Chamber Displacement Volume (gallons)

DN50	DN65	DN80	DN100	DN150	DN200	DN250	DN300-400
0.03	0.05	0.08	0.18	0.52	1.02	1.02	3.63

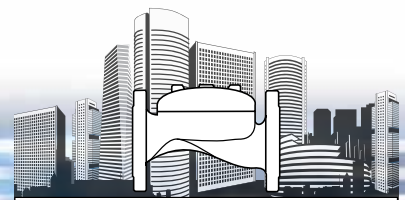

## Globe Pattern

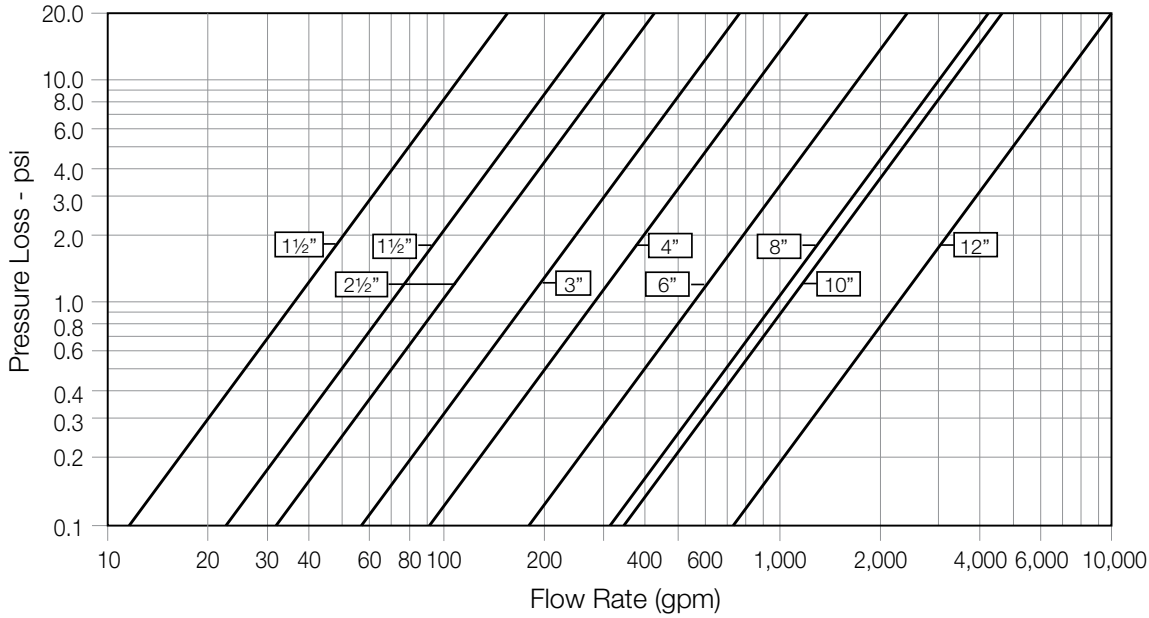

## Angle Pattern

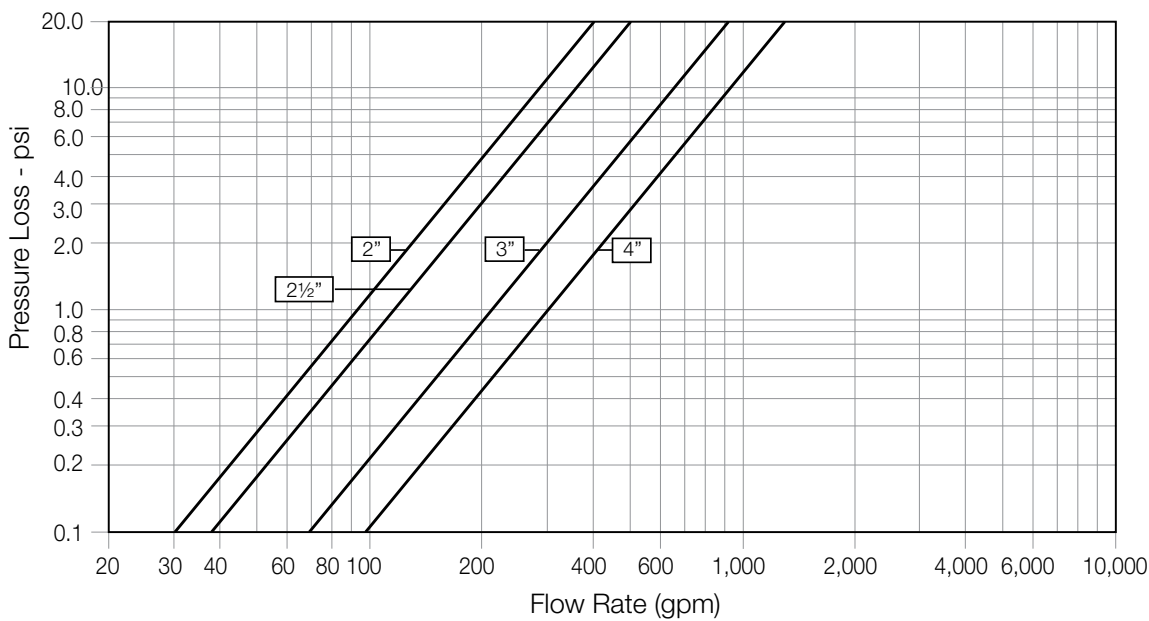

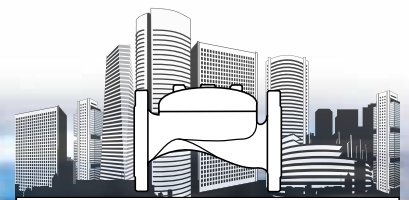

**US** English

		2"	2½"	3"	4"	6"	8"	10"	12-16"
Globe Pattern 	CV	66	90	157	236	529	902	957	2,231
	K	3.2	4.2	2.9	4.0	4.0	4.4	3.9	3.6
	Leq - ft	30	40	45	46	90	150	354	187

### Differential Pressure Calculation

Valve flow coefficient, Kv or Cv 
$$Kv(Cv) = Q \sqrt{\frac{Gf}{\Delta P}}$$

**Where:**

Kv = Valve flow coefficient (flow in m<sup>3</sup>/h at 1bar Diff. Press.)

Cv = Valve flow coefficient (flow in gpm at 1psi Diff. Press.)

(Cv = 1.155 Kv)

Q = Flow rate (m<sup>3</sup>/h; gpm)

ΔP = Differential pressure (bar; psi)

Gf = Liquid specific gravity (Water = 1.0)

Flow resistance or Head loss coefficient 
$$K = \Delta H \frac{2g}{V^2}$$

**Where:**

K = Flow resistance or Head loss coefficient (dimensionless)

ΔH = Head loss (m; feet)

V = Nominal size flow velocity (m/sec; feet/sec.)

g = Acceleration of gravity (9.81 m/sec<sup>2</sup>; 32.18 feet/sec<sup>2</sup>)

Equivalent Pipe Length, Leq 
$$Leq = Lk \cdot D$$

**Where:**

Leq = Equivalent nominal pipe length (m; feet)

Lk = Equivalent length coefficient for turbulent flow in clean commercial steel pipe (SCH 40)

D = Nominal pipe diameter (m; feet)

**Note:** The Leq values given are for general consideration only.



[info@bermad.com](mailto:info@bermad.com) • [www.bermad.com](http://www.bermad.com)

The information herein is subject to change without notice. BERMAD shall not be held liable for any errors. All rights reserved.  
© Copyright by BERMAD.

PT7BEES-WW