

## Pneumatic Pressure Control Deluge Valve with Local Reset

### Model FP 400Y - 4DC-H

The BERMAD model 400Y-4DC-H is an elastomeric hydraulic, line pressure operated, deluge valve, designed specifically for advanced fire protection systems and the latest industry standards.

The 400Y-4DC-H is activated by a pneumatic relay valve which latches the main valve open until locally reset.

An integrated pressure reducing pilot valve ensures a stable and precise pre-set downstream water pressure.

An optional valve position indicator can include a limit switch suitable for Fire & Gas monitoring systems.

The 400Y-4DC-H is ideal for open-nozzle systems with a high pressure water supply and/or relatively low flow. The pneumatic control makes the 400Y-4DC-H suitable for freezing environments and corrosive water supplies.



for illustration only

### Benefits and Features

#### ■ Safety and reliability

- Time-proven, simple, fail-safe actuation
- Single-piece, rugged, elastomeric diaphragm seal - VRSD technology
- Obstacle-free, uninterrupted flow path
- No mechanical moving parts
- Ensures precise, stable downstream water pressure
- Valve position limit switches (optional)

#### ■ High performance

- Very high flow efficiency
- Straight-through-flow Y-type body
- Approved for PN25 (365 psi)

#### ■ Designed for fire protection

- Face-to-face length standardized to ISO 5752, EN 558-1
- Suitable for corrosive fluids and freezing temperatures: pneumatic relay valve
- Designed to meet the requirements of the industry standards

#### ■ Quick and easy maintenance

- In-line serviceable
- Fast and easy cover removal
- Swivel mounted drain valves\*

\* not including 1½" & 2" valves

### Typical Applications

- Fusible plug loops
- Automatic water spray systems
- Foam applications
- Corrosive water supplies
- High pressure water supply
- Freezing conditions

### Approvals



UL-Listed  
Special System Water Control  
Valves, Deluge Type (VLFT)  
Sizes 1½" - 16"



Det Norske Veritas  
Type Approval



ABS  
American Bureau of Shipping  
Type Approval



Lloyd's Register  
Type Approval

### Additional Features

- Valve position limit switches
- Sea water compatibility
- Drain Valve/s Inlet/Outlet
- Air maintenance device

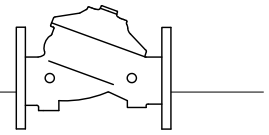

## Operation

for illustration only

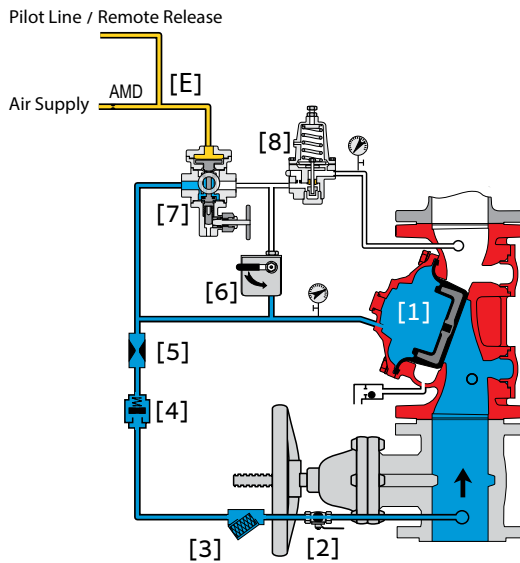

**Valve Closed** (normal conditions)

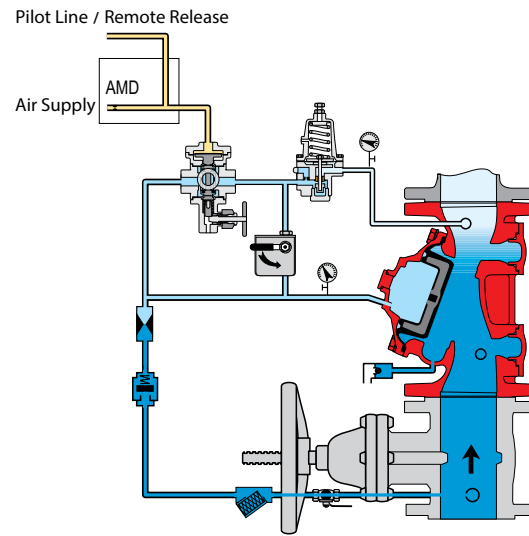

**Valve Open** (fire conditions)

The BERMAD model 400Y-4DC-H is held closed by water pressure in the control chamber [1]. Upon release of pressure from the control chamber, the valve opens.

Under NORMAL conditions, water pressure is supplied to the control chamber via the priming line [2] strainer [3] and restriction orifice [5], it is then trapped in the control chamber by a check valve [4], manual emergency release [6], and a latching relay valve (URV-M) [7] that is held closed by pneumatic pressure in the dry pilot line [E]. The water pressure trapped in the main valve control chamber holds the diaphragm against the valve seat, sealing it drip-tight and keeping the system pipes dry.

Under FIRE conditions, water pressure is released from the control chamber, either with the manual emergency release, or by the URV-M opening automatically in response to a decrease in pneumatic pilot-line pressure. This opens the 400Y-4DC-H deluge valve, allowing water to flow into the system piping and to the alarm device. Once open the 400Y 4DC-H latches open until reset locally.

The pressure-reducing pilot valve [8] senses changes in outlet pressure and modulates the main valve to maintain the set downstream pressure. When outlet pressure changes, the pressure-reducing pilot opens or closes in response. This regulates the pressure in the main valve's control chamber, thus modulating the position of the diaphragm seal disk to maintain the set downstream pressure.

## System P&ID

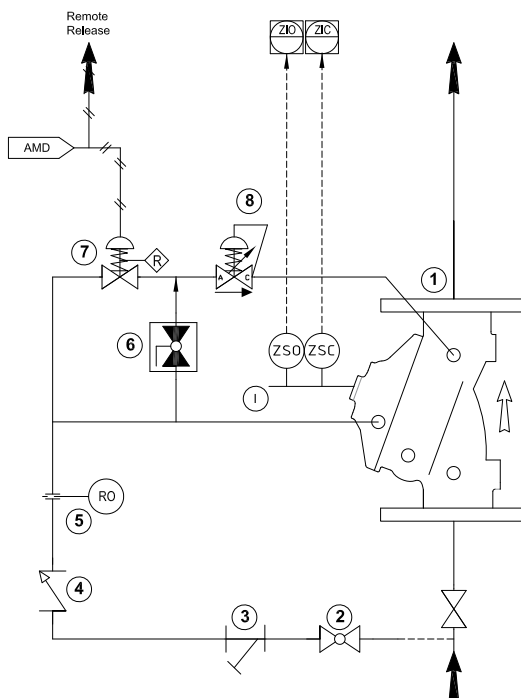

### Components

- 1 BERMAD 400Y Deluge Valve
- 2 Priming Ball Valve
- 3 Priming Strainer
- 4 Check Valve
- 5 Restriction Orifice
- 6 Manual Emergency Release
- 7 URV-2-M Relay Valve
- 8 Pressure Reducing Pilot Valve

### Optional System Items

- ZS Limit Switch Assembly
- AMD Air Maintenance Device
- I Visual Indicator

See also Factory Fitted Options under the Valve Code Designations on the last page

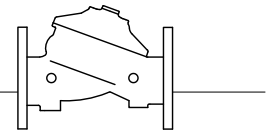

## System Installation

A typical installation of the BERMAD model 400Y-4DC-H features automatic actuation via a pneumatic universal relay valve, triggered by a fusible plug loop. Once open the relay pilot URV-M will latch mechanically keeping the 400Y 4DC-H open, until locally reset. A pressure reducing pilot valve within the trim controls the main valve to ensure a precise, pre-set, stable downstream water pressure.

When fitted with a limit switch the valve can send a feedback signal to a remote valve position monitoring system.

## Optional System Items

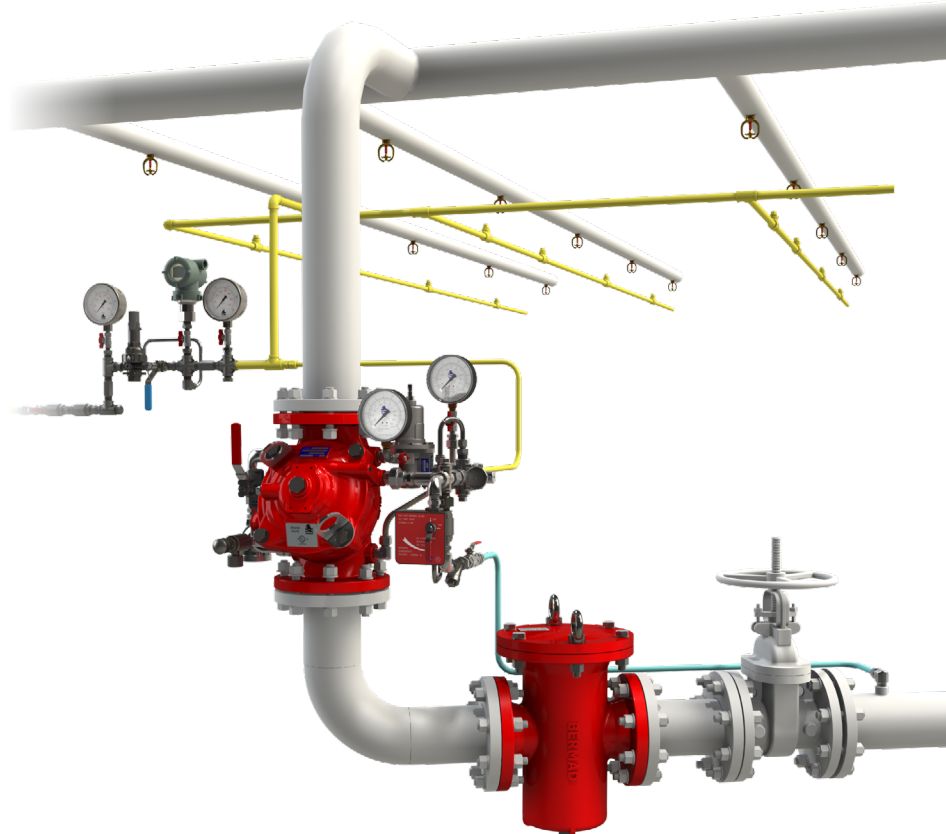
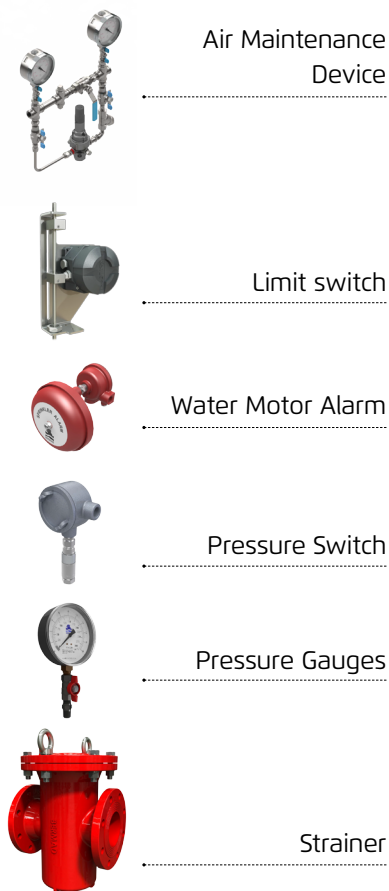

for illustration only

## Suggested Specifications

The deluge valve shall be a UL-listed, 25-bar/365-psi rated, elastomeric type, with a straight-through Y-type-body. The valve shall have an unobstructed flow path, with no stem guide or supporting ribs. Valve actuation shall be accomplished by a single-piece, rolling diaphragm bonded with a rugged radial seal disk. The diaphragm assembly shall be the only moving part.

The deluge valve shall include a latching relay pilot valve, a pressure reducing pilot valve, a Y-type strainer, a ball drain valve, an automatic drip-check with manual override, 4-inch pressure gauges, and a manual emergency release housed in a stainless steel box. The valve drain socket shall be flanged and have 360-degree swivel.

The valve shall be equipped with two limit switches.

Removing the valve cover for inspection and maintenance shall be in-line and not require removing the control trim.

The deluge valve and its entire control trim shall be supplied pre-assembled and hydraulically tested by a factory certified to ISO 9000 and 9001 standards.

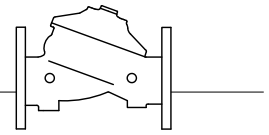

## Technical Data

### Available Sizes (inch)

- Flanged - 1½, 2, 3, 4, 6, 8, 10, 12, 14 & 16"
- Grooved - 1½, 2, 3, 4, 6 & 8"
- Threaded - 1½ & 2"

### Pressure Rating

- ANSI#150 - 16 bar / 235 psi
- ANSI#300 - 1½" to 10" 25 bar / 365 psi  
12" to 16" 20 bar / 300 psi
- Grooved/Threaded - 25 bar / 365 psi
- Setting range: 4 - 12 bar (60 - 175 psi)

### Elastomer

- HTNR - Fabric Reinforced High Temperature Compound - See engineering data

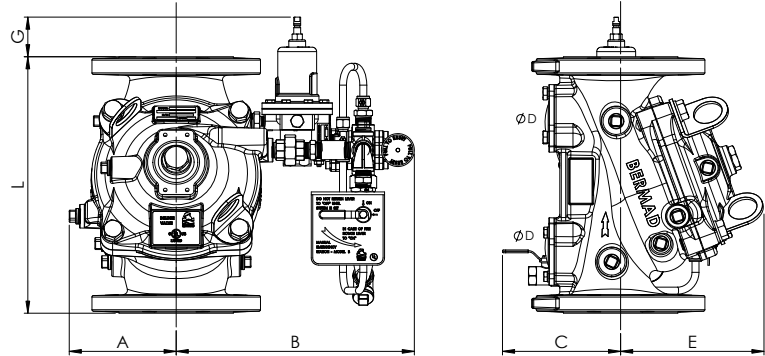

Valve Size	1½" DN40		2" DN50		3" DN80		4" DN100		6" DN150		8" DN200		10" DN250		12" DN300		14" DN350		16" DN400	
	mm	in	mm	in	mm	in	mm	in	mm	in	mm	in	mm	in	mm	in	mm	in	mm	in
L <sup>(1)</sup>	230	9.1	230	9.1	310	12.2	350	13.8	480	18.9	600	23.6	730	28.7	850	33.5	980	38.6	1100	43.3
L <sup>(2)</sup>	230	9.1	238	9.4	326	12.8	368	14.5	506	19.9	626	24.6	730	28.7	888	35	980	38.6	1100	43.3
A	84	3.3	84	3.3	144	5.7	152	6.0	205	8.1	235	9.3	235	9.3	348	13.7	348	13.7	348	13.7
B	264	10.4	264	10.4	322	12.7	286	11.3	387	15.2	415	16.3	415	16.3	528	20.8	528	20.8	528	20.8
C	122	4.8	122	4.8	166	6.5	162	6.4	140	5.5	172	6.8	204	8	242	9.5	270	10.6	310	12.2
ØD	¾"		¾"		1½"		2"		2"		2"		2"		2"		2"		2"	
E	120	4.7	120	4.7	146	5.7	158	6.2	228	9.0	295	11.6	295	11.6	441	17.4	441	17.4	415	16.3
G	78	3.1	78	3.1	68	2.7	55	2.2	6.5	0.3	-	-	-	-	-	-	-	-	-	-
Kv / Cv <sup>(4)</sup>	68 / 79		80 / 92		190 / 219		345 / 398		790 / 912		1160 / 1340		1355 / 1565		2370 / 2737		2850 / 3292		3254 / 3758	
Leq <sup>(3)</sup> : m/ft	2 / 7		5 / 16		7 / 23		9 / 30		15 / 49		27 / 89		62 / 203		52 / 171		59 / 194		88 / 289	
Kg/lb (flanged#150/ISO16)	17.9 / 39.4		19.3 / 42.5		34 / 74.8		44 / 95.8		87.3 / 192		150 / 331		180 / 397		323 / 712		356 / 784		403 / 886	

- Notes:**
- <sup>(1)</sup> Refers to the length dimensions for Raised Face ANSI #150, ISO 16 Flanged, Threaded and Grooved valves
  - <sup>(2)</sup> Refers to the length dimensions for Raised Face ANSI #300 and ISO 25 Flanged valves
  - <sup>(3)</sup> Leq (Equivalent Pipe Length) refers to a fully opened valve with turbulent flow in new steel pipe schedule 40, values given for general consideration only
  - <sup>(4)</sup> Pressure loss coefficient given for fully opened valve, conditions below pressure regulating set point
  - <sup>(5)</sup> Dimensions for the trim envelope may vary with specific component positioning

## Valve Code Designations

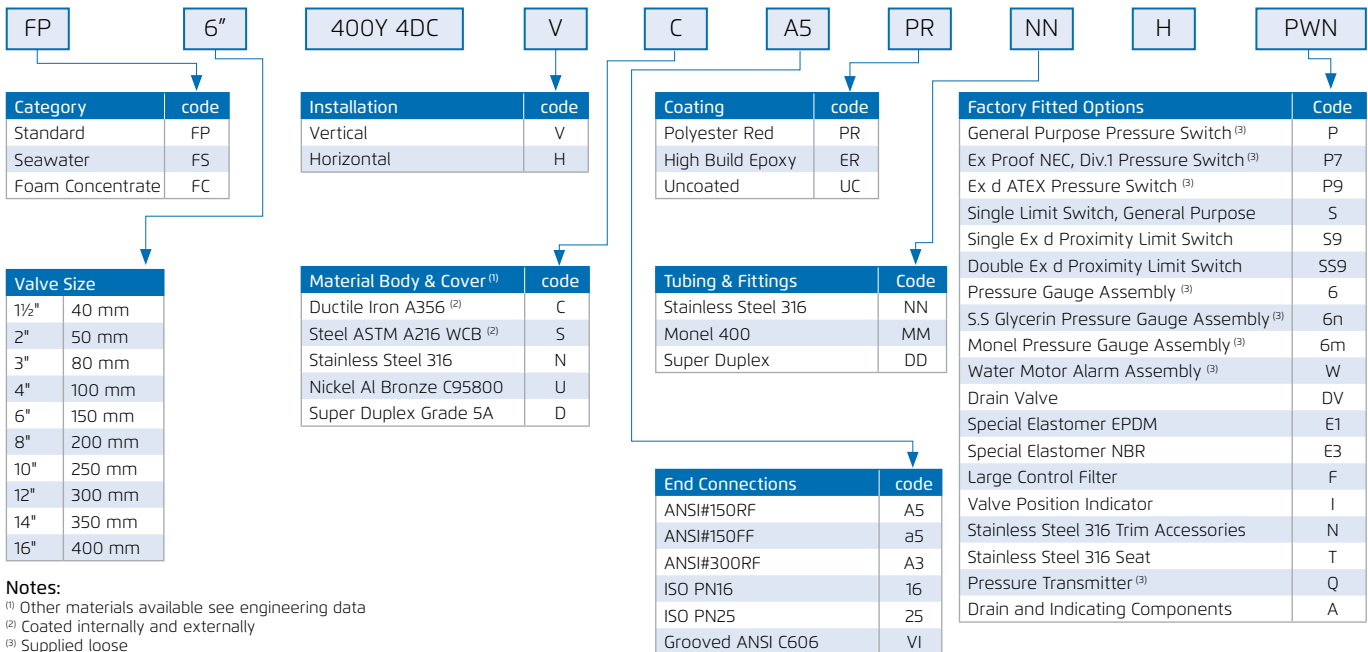

- Notes:**
- <sup>(1)</sup> Other materials available see engineering data
  - <sup>(2)</sup> Coated internally and externally
  - <sup>(3)</sup> Supplied loose

